

585E-OM1712-02

# OPERATION MANUAL

---

---

---

## CRAWLER CRANE

# CC1485S-1

Serial No. 7048 and up

### **WARNING**

Unsafe use of this machine may cause serious injury or death. Operators must read this manual before operating this machine. This manual should be kept near the machine for reference and periodically reviewed by all personnel who will come into contact with it.

### **NOTICE**

MAEDA has Operation Manuals written in some other languages. If a foreign language manual is necessary, contact your local distributor for availability.

# M A E D A





# CONTENTS

Item	Page
INTRODUCTION	1
1. INTRODUCTION	2
2. FOR SAFE USE OF THE MACHINE	3
3. MACHINE OVERVIEW	4
3.1 SPECIFIED OPERATIONS	4
3.2 MACHINE STRUCTURE	4
3.3 MACHINE FUNCTIONS	5
4. QUALIFICATION FOR OPERATION	6
4.1 QUALIFICATION FOR CRANE OPERATION	6
5. CRANETERMINOLOGY	7
5.1 TERMS AND DEFINITIONS	7
5.2 DIAGRAM OF WORKING RADIUS AND LIFTING HEIGHT	8
5.3 RATED TOTAL LOAD CHART	9
SAFETY	13
1. BASIC PRECAUTIONS	14
1.1 PRECAUTIONS BEFORE STARTING WORK	14
1.2 PREPARING FOR SAFE OPERATION	15
1.3 PRECAUTIONS FOR FIRE PREVENTION	17
1.4 CAUTIONS IN GETTING ON AND OFF THE MACHINE	18
1.5 OTHER PRECAUTIONS	19
2. OPERATION RELATED PRECAUTIONS	20
2.1 PRECAUTIONS ON WORK SITE	20
2.2 CAUTIONS WHEN STARTING ENGINE	23
2.3 PRECAUTIONS FOR STARTING CARRIER AND OPERATING CRANE	25
2.4 CAUTIONS DURING CRANE OPERATION	29
3. TRANSPORT PRECAUTIONS	37
4. MAINTENANCE PRECAUTIONS	39
4.1 PRECAUTIONS BEFORE MAINTENANCE	39
4.2 PRECAUTIONS DURING MAINTENANCE	43
5. SAFETY LABEL LOCATIONS	48



Item	Page
OPERATION	59
1. NAME OF EACH SECTION	60
1.1 MACHINE UNITS	60
1.2 CRANE OPERATION UNITS	61
1.2.1 MACHINE MONITOR COMPONENTS	62
2. EXPLANATION OF ALL EQUIPMENT	63
2.1 MACHINE MONITOR	63
2.1.1 MONITOR BASIC ACTION AND DISPLAY	65
2.1.2 WARNING DISPLAY	72
2.2 SWITCHES	75
2.3 OPERATION LEVERS AND PEDALS	85
2.4 MOMENT LIMITER (OVERLOAD PREVENTIVE DEVICE)	89
2.4.1 CONFIGURATION OF MOMENT LIMITER	89
2.4.2 FUNCTIONS OF MOMENT LIMITER	90
2.4.3 MOMENT LIMITER OPERATION AND CANCELING (RECOVERY)	91
2.4.4 MOMENT LIMITER FUNCTIONS	94
2.4.5 MOMENT LIMITER CANCELING SWITCH	102
2.5 OVERWINDING PREVENTION DEVICE	104
2.6 AIR CONDITIONER HANDLING	105
2.6.1 COMPONENTS OF CONTROL PANEL	105
2.6.2 AIR CONDITIONER OPERATION METHOD	109
2.6.3 PRECAUTIONS IN AIR CONDITIONER USE	111
2.6.4 INSPECTION AND MAINTENANCE OF AIR CONDITIONER INSTALLED ON THE MACHINE	111
2.7 CAR RADIO HANDLING	112
2.7.1 EXPLANATION OF THE EQUIPMENT	112
2.7.2 CAR RADIO OPERATION METHOD	115
2.7.3 PRECAUTIONS IN CAR RADIO USE	117
2.8 FUSE	118
2.9 FUSIBLE LINK	119
2.10 CONTROLLER	120
2.11 CAB FRONT WINDOW	121
2.12 DOOR	123
2.13 HAMMER FOR EMERGENCY ESCAPE	124
2.14 CAP AND COVER WITH LOCK	125
2.15 BATTERY ROOM DOOR	126
2.16 LEFT COVER	126
2.17 RIGHT COVER	127
2.18 MACHINERY COVER	128
2.19 HOLDER FOR OPERATION MANUAL	128
2.20 GREASE PUMP HOLDER	129
2.21 CUP HOLDER	129
2.22 RETRACTABLE SEAT BELT HANDLING	129





Item	Page
3. OPERATION	130
3.1 PRE-OPERATION INSPECTION	130
3.1.1 CHECKING BEFORE STARTING ENGINE	130
3.1.2 CHECKING BEFORE STARTING ENGINE	133
3.1.3 CHECKING AFTER STARTING ENGINE	147
3.2 OPERATIONS AND CHECKS BEFORE STARTING ENGINE	150
3.3 STARTING ENGINE	151
3.4 OPERATIONS AND CHECKS AFTER STARTING ENGINE	153
3.4.1 WARM-UP OPERATIONS FOR ENGINE	153
3.4.2 WARM-UP OPERATIONS FOR HYDRAULIC EQUIPMENT	154
3.5 STOPPING ENGINE	156
3.6 BREAK-IN OPERATION	157
3.7 MACHINE TRAVELLING POSTURE	157
3.8 STARTING (FORWARD AND BACKWARD)/STOPPING THE MACHINE	158
3.9 CHANGING DIRECTION OF THE MACHINE	161
3.10 SLEWING THE MACHINE	162
3.11 PARKING THE MACHINE	163
3.12 INSPECTION AND CHECK AFTER COMPLETING WORK	164
3.12.1 AFTER STOPPING ENGINE	164
3.12.2 LOCKING	164
3.13 CAUTIONS IN DRIVING	165
3.14 PRECAUTIONS BEFORE CRANE OPERATION	168
3.15 OPERATION BEFORE CRANE WORK	170
3.16 CRANE OPERATION POSTURE	172
3.17 HOISTING AND LOWERING OPERATION	173
3.17.1 NORMAL HOISTING AND LOWERING OPERATION	173
3.17.2 HOISTING AND LOWERING OPERATION AT HIGH SPEED	174
3.17.3 HOISTING OPERATION WITH HOOK STOWAGE SWITCH	175
3.18 BOOM DERRICKING OPERATION	176
3.19 BOOM TELESCOPING OPERATION	177
3.20 SLEWING OPERATION	179
3.21 ACCELERATOR OPERATION	180
3.22 CRANE STOWAGE OPERATION	182
3.22.1 CRANE STOWAGE OPERATION AT THE TIME OF SIMPLE STOWAGE OF HOOK BLOCK	182
3.22.2 CRANE STOWAGE OPERATION AT THE TIME OF NORMAL STOWAGE OF HOOK BLOCK	185
3.23 PROHIBITED OPERATIONS DURING CRANE WORK	187
3.24 OPERATION DURING TRAVELLING HOIST	189
3.24.1 PRECAUTIONS IN OPERATION DURING TRAVELLING HOIST	189
3.24.2 OPERATION POSTURE DURING TRAVELLING A HOISTED LOAD	190
3.24.3 OPERATION OF TRAVELLING A HOISTED LOAD WORK	191
3.24.4 CANCEL OPERATION OF TRAVELLING HOIST OPERATION POSTURE	191



Item	Page
4. HANDLING OF WIRE ROPE	192
4.1 CRITERIA FOR WIRE ROPE REPLACEMENT	192
4.2 WINCH WIRE ROPE REEVING SYSTEM AND GROSS RATED LOAD	194
4.3 MEASURE TO TAKE WHEN WINCH WIRE ROPE IS TWISTED	195
5. TRANSPORTATION	197
5.1 LOADING/UNLOADING	197
5.1.1 LOADING	198
5.1.2 FIXING THE MACHINE	200
5.1.3 UNLOADING	201
5.2 HOISTING MACHINE	202
5.2.1 HOISTING MACHINE WITH BOOM LOWERED	202
5.2.2 HOISTING MACHINE WITH BOOM	204
5.3 CAUTIONS DURING TRANSPORTATION	205
6. HANDLING WHEN COLD	206
6.1 PREPARING FOR LOW TEMPERATURE	206
7. LONG-TERM STORAGE	208
7.1 BEFORE STORING MACHINE	208
7.2 DURING STORAGE	208
7.3 AFTER STORAGE	209
8. TROUBLESHOOTING	210
8.1 WHEN FUEL RUNS OUT	210
8.2 PHENOMENONS THAT ARE NOT A FAULT	211
8.3 WHEN BATTERY HAS DISCHARGED	212
8.3.1 BATTERY HANDLING PRECAUTIONS	212
8.3.2 REMOVING/INSTALLING BATTERY	213
8.3.3 CAUTIONS IN CHARGING BATTERY	214
8.3.4 STARTING ENGINE WITH BOOSTER CABLE	215
8.4 WHEN SUCH A PHENOMENON OCCURS	217
8.4.1 ELECTRICAL COMPONENTS	217
8.4.2 MACHINE BODY COMPONENTS	219
8.4.3 ENGINE COMPONENTS	220
8.4.4 MOMENT LIMITER COMPONENTS	222
8.4.5 OVERWINDING PREVENTION DEVICE	223



Item	Page
INSPECTION AND MAINTENANCE	225
1. PRECAUTIONS FOR MAINTENANCE	226
2. BASIC MAINTENANCE	228
3. LEGAL INSPECTION	232
4. PERIODIC REPLACEMENT OF CRITICAL PARTS	233
5. CONSUMABLES	234
6. OTHER REPLACEMENT PARTS	235
7. USE OF FUEL AND LUBRICATING OIL	236
7.1 USE OF FUEL AND LUBRICATING OIL ACCORDING TO TEMPERATURES	236
8. STANDARD TIGHTENING TORQUE	238
8.1 STANDARD TIGHTENING TORQUE LIST	238
9. LIST OF ITEMS FOR INSPECTION AND MAINTENANCE	239
10. MAINTENANCE PROCEDURES	241
10.1 INITIAL 500 HOUR MAINTENANCE	241
10.2 PRE-OPERATION INSPECTION	241
10.3 IRREGULAR MAINTENANCE	242
10.4 MAINTENANCE EVERY 50 HOURS	258
10.5 MAINTENANCE EVERY 250 HOURS	260
10.6 MAINTENANCE EVERY 500 HOURS	264
10.7 MAINTENANCE EVERY 1000 HOURS	274
10.8 MAINTENANCE EVERY 1500 HOURS	279
10.9 MAINTENANCE EVERY 3000 HOURS	279
10.10 MAINTENANCE EVERY 4000 HOURS	280
10.11 MAINTENANCE EVERY 5000 HOURS	281
11. VENTING AIR IN HYDRAULIC CIRCUITS	284
12. RELIEVING INTERNAL PRESSURE OF HYDRAULIC CIRCUIT	288
13. ATTACHING/DETACHING SINGLE-FALL HOOK	289
13.1 ATTACHING SINGLE-FALL HOOK	289
13.2 DETACHING SINGLE-FALL HOOK	292
SPECIFICATIONS	295
1. PRINCIPLE SPECIFICATION LIST	296
2. SPECIFICATION DIMENSIONAL DRAWING	297
3. RATED TOTAL LOAD CHART	298
4. WORKING RADIUS/LIFTING HEIGHT	301



Item	Page
FLY-JIB	303
1. PRECAUTIONS OF FLY-JIB OPERATION	304
2. SAFETY LABEL LOCATION	306
3. FLY-JIB EACH SECTION	309
4. FLY-JIB INSTALLATION AND STOWAGE	310
4.1 INSTALLATION OF FLY-JIB	311
4.2 CHANGING OF FLY-JIB TILT ANGLE	316
4.3 EXTENDING AND RETRACTING NO.2 FLY-JIB	321
4.3.1 EXTENDING NO.2 FLY-JIB CONFIGURED 0 DEGREE OR 20 DEGREES TILT ANGLE	321
4.3.2 EXTENDING NO.2 FLY-JIB CONFIGURED 40 DEGREES OR 60 DEGREES TILT ANGLE	322
4.3.3 RETRACTING OF No.2 FLY-JIB	324
4.4 STOWAGE OF FLY-JIB	325
4.5 REMOVAL OF FLY-JIB	330
4.6 INSTALLATION OF FLY-JIB	334
5. HANDLING MONITOR AND MOMENT LIMITER	342
5.1 NAMES OF MONITOR DISPLAY	342
5.1.1 MONITOR DISPLAY IN FLY-JIB MODE	342
5.1.2 MONITOR DISPLAY WHEN FLY-JIB IS STOWED	344
5.2 MOMENT LIMITER FUNCTIONS	345
5.2.1 DISPLAY FOR FLY-JIB MODE SWITCHING	346
5.3 SETTING OF OPERATING CONDITIONS	347
6. OPERATIONS	348
6.1 CAUTIONS FOR FLY-JIB OPERATION	348
7. TROUBLESHOOTING	349
7.1 LIST OF ERROR CODES	349
7.2 WHEN SUCH A PHENOMENON OCCURS	350
8. INSPECTION AND MAINTENANCE	351
8.1 CHECKING BEFORE OPERATION	351
8.2 MAINTENANCE EVERY 50 HOURS	353
9. SPECIFICATIONS	354
9.1 SPECIFICATION TABLE	354
9.2 SPECIFICATION DIMENSIONAL DRAWING	355
9.3 RATED TOTAL LOAD CHART	356
9.4 WORKING RADIUS/LIFTING HEIGHT	357
9.4.1 WORKING RADIUS/LIFTING HEIGHT (WHEN FLY-JIB ANGLE IS 0 DEGREES AND 20 DEGREES)	357
9.4.2 WORKING RADIUS/LIFTING HEIGHT (WHEN FLY-JIB ANGLE IS 40 DEGREES AND 60 DEGREES)	358



# INTRODUCTION

1. INTRODUCTION	2
2. FOR SAFE USE OF THE MACHINE	3
3. MACHINE OVERVIEW	4
4. QUALIFICATION FOR OPERATION	6
5. CRANE TERMINOLOGY	7



## 1. INTRODUCTION

Thank you for purchasing Maeda Crawler Crane CC1485S-1.

This manual is a guidebook for safe and effective use of this machine.

This manual describes the procedures and precautions to follow for proper operation and maintenance of the machine.

Be sure to read this manual and understand the procedures for machine operation, inspection, and maintenance thoroughly before using this machine.

Failure to observe the basic precautions described in this manual may lead to serious accidents.

### **⚠ WARNING**

**Improper operation of this machine can lead to serious injuries or death. Operators and maintenance personnel must always read this manual prior to operation or maintenance of this machine.**

**Keep this manual in a designated place so that all personnel that work on this machine will read it for reference periodically.**

- **Avoid operating this machine before understanding this manual thoroughly.**
- **Keep this manual at hand so that you can read it when necessary.**
- **If you lose or damage this manual, contact Maeda or our sales service agency immediately to order a new one.**
- **This manual should always accompany this machine upon transfer of the machine to the next owner.**  
**If the machine is resold to a third party without informing us in advance, no warranty whatsoever shall be applicable.**
- **This manual is based on the data that was available at the time of the creation of the manual.**  
**The information in this manual, including maintenance specifications, tightening torque, pressure, measuring method, adjustment value, and illustrations, are subject to change without prior notice due to continuous machine improvement.**  
**These changes may affect the machine maintenance procedure. Always obtain the latest information from Maeda or our sales service agency before performing maintenance of this machine.**

**For safety instructions, see "2. FOR SAFE USE OF THE MACHINE" on page 3 and "SAFETY" on pages 13 and above.**

#### **[Storage place of the operation manual]**

Magazine box at the left side of operator's seat

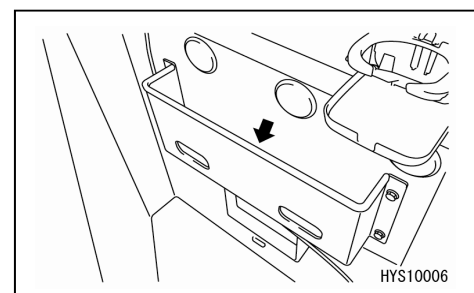



## 2. FOR SAFE USE OF THE MACHINE

This manual classifies the risks into the following categories for easy understanding of this manual and the safety labels attached to this machine.

**DANGER**

This denotes that there is an imminent hazard which will cause serious injury or death.  
It also provides information on how to avoid such hazard.

**WARNING**

This denotes that there is a hazard which can cause serious injury or death.  
It also provides information on how to avoid such hazard.

**CAUTION**

This denotes that there is a potential hazard which may cause minor or moderate injury or serious damage to the machine.  
It also provides information on how to avoid such hazard.

This manual also uses the following indications to provide other precautions for handling the machine and helpful information.

**CAUTION**

This denotes that failure to properly handle the machine may damage it or shorten its life.

**NOTES**

This denotes helpful information.

The operations, inspections, maintenance and safety precautions for this machine that are outlined in this manual are relevant to specified tasks.

Thus, the precautions given in this manual and on this machine do not necessarily cover every safety issue.

When performing the machine operation, inspection or maintenance in a situation that is not covered by this manual, be sure to take necessary measures and actions for safety on your own.

Even in the above case, never attempt work or operations that this manual prohibits you to do.

### 3. MACHINE OVERVIEW

#### 3.1 SPECIFIED OPERATIONS

This machine is to be used for the following operations:

- Crane operation
- Travelling suspension operation

This machine is a mobile crane consisting of the upper swiveling body equipped with a boom type crane and the lower crawler type carrier.

This self-propelled crane is capable of moving (travelling) in the worksite and lifting an object weighing up to the rated total load.

#### 3.2 MACHINE STRUCTURE

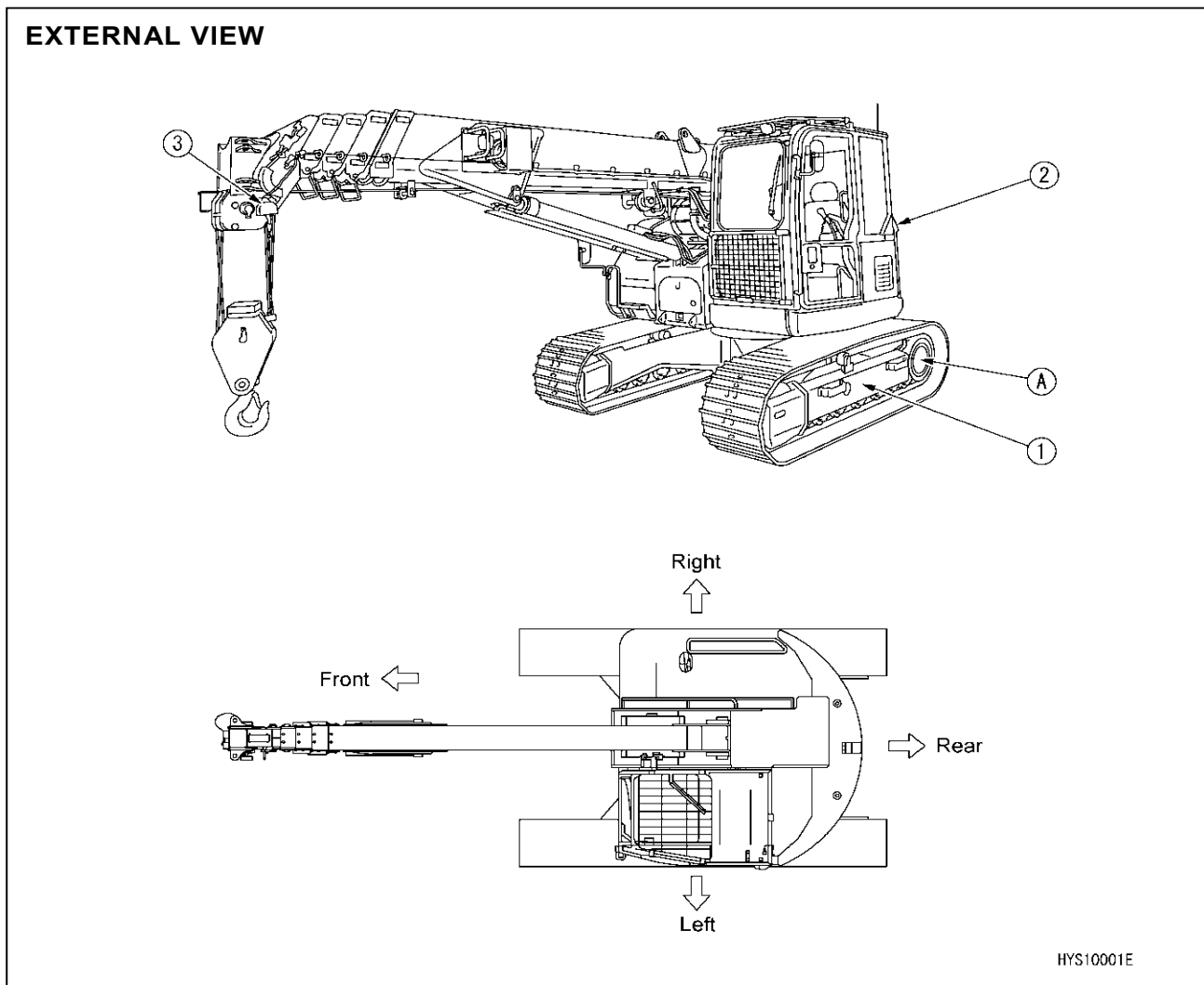

- (1) Carrier
- (2) Upper slewing body
- (3) Safety device

In this manual, the front, rear, left and right directions are defined with the basic reference direction that the operator sits on the operator's seat with the carrier's sprocket (A) at the rear and viewing the machine's traveling direction (forward). For the slewing of boom (upper slewing body), the boom slewing directions (clockwise for right and counterclockwise for left) are determined as viewed from above the machine.





This machine is composed of the following units and systems:

**[1] CARRIER**

Consists of the traveling system.

**[2] CRANE**

Consists of the engine, travelling operation unit, crane operation unit, boom telescoping unit, boom derricking unit, slewing unit, hook block and winch system.

**[3] SAFETY DEVICE**

Comprises the overwinding prevention device, over-unwinding prevention device, overload preventive device, slinging rope detachment protector, hydraulic safety valve, telescoping cylinder hydraulic automatic locking device, derricking cylinder hydraulic automatic locking device, alarm buzzer, machine body inclination alarm, leveling instrument, working status lamp, and the crane and travelling operation locking lever.

### **3.3 MACHINE FUNCTIONS**

**[1] CARRIER**

- The carrier is of a crawler type, which facilitates running in rough terrain and soft ground.
- Operating the two travelling levers enables not only travelling direction changes (forward, backward, right and left) but also pivot turns and spin turns.

**[2] UPPER SLEWING BODY**

- The upper slewing body is allowed to perform 360 degrees slewing by slewing operation.
- Through the combined use of the telescopic boom, derrick and slewing systems besides the winch system, the crane can raise and lower the hook block to move the lifted object to the desired position within the rated total load and the specified working envelope.



## 4. QUALIFICATION FOR OPERATION

### **WARNING**

- **A high incidence of occupational accidents in crane operation has been reported. Be aware that experienced engineers are also no exception.**
- **Warnings and precautions defined in this manual shall be observed for safety assurance during operation of the machine.**

### 4.1 QUALIFICATION FOR CRANE OPERATION

Only personnel that have obtained the required license or training stipulated by laws and regulations applicable to the place of use are qualified to operate this machine.

Contact the relevant government office or our sales service agency for further information.



## 5. CRANE TERMINOLOGY

### 5.1 TERMS AND DEFINITIONS

#### [1] RATED TOTAL LOAD

The maximum load that can be applied according to the boom length and angle. The load includes the mass (weight) of hoisting accessories (hooks) and slinging ropes.

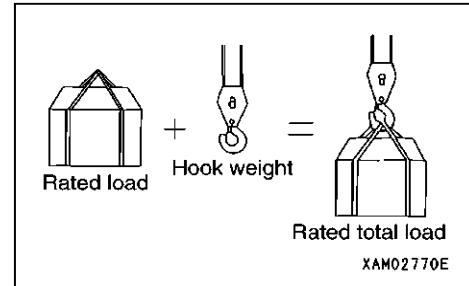

#### [2] RATED LOAD

A load derived by subtracting the mass (weight) of hoisting accessories (hooks) and slinging ropes from the rated total load, and can be hoisted.

#### [3] WORKING RADIUS

A horizontal distance between the axis of slewing and the hook centre.

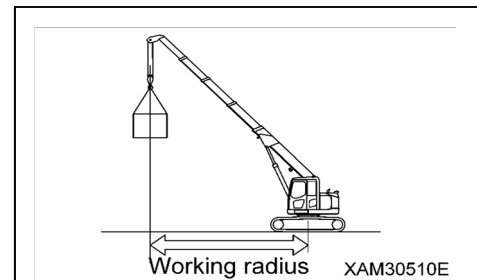

#### [4] BOOM LENGTH

Refers to the distance between the boom primary pin and the sheave pin of the boom end.

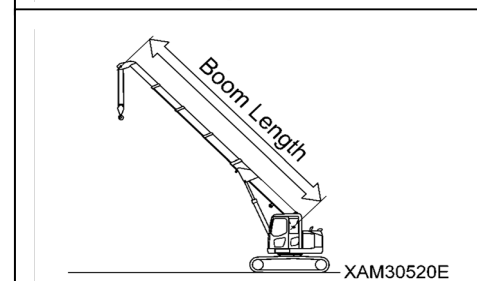

#### [5] BOOM DERRICK ANGLE

Refers to the angle which the boom forms with the horizon.

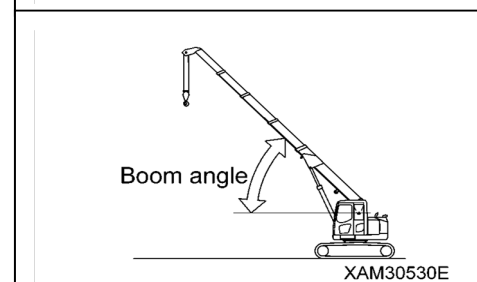

#### [6] LIFTING HEIGHT ABOVE GROUND

A vertical distance between the hook bottom end and the ground with the hook raised to the upper limit.

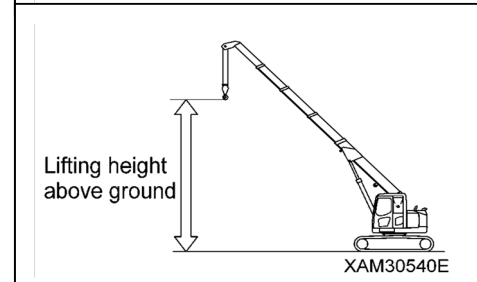

## 5.2 DIAGRAM OF WORKING RADIUS AND LIFTING HEIGHT

### ⚠ WARNING

- The working radius/lifting height shows relationship between working radius, boom angle and lifting height above ground of this machine with no load hoisted, and deflection of the boom is not included.
- Stage "4" in the diagram of working radius and lifting height indicates that one half portion of the "▾" mark is extruding from the 4th stage boom.

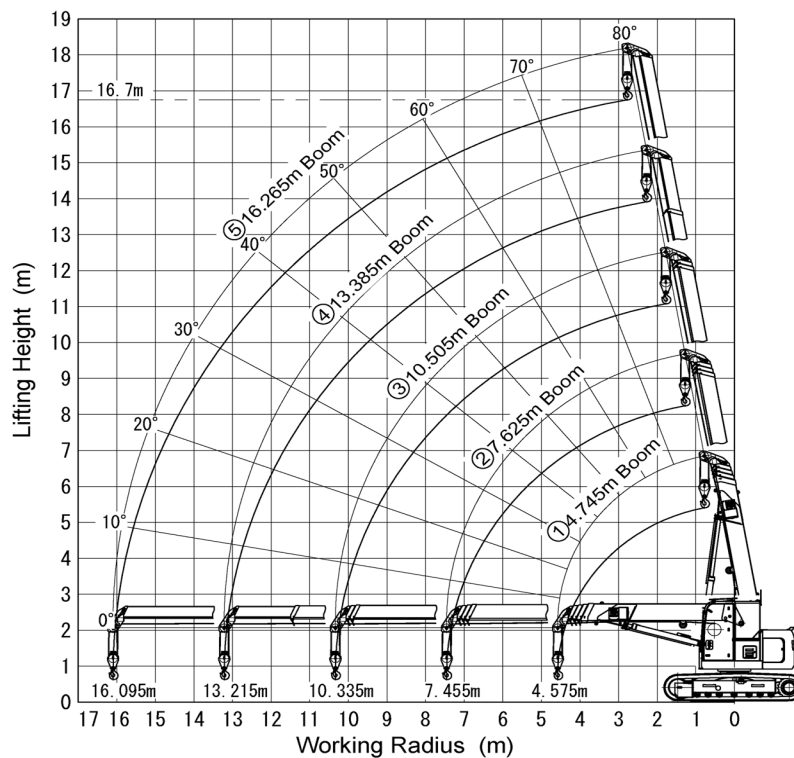

HYS10002E

1. The point A in the figure at right indicates the boom angle and point B the lifting height above ground. The working radius of points A and B are the same.

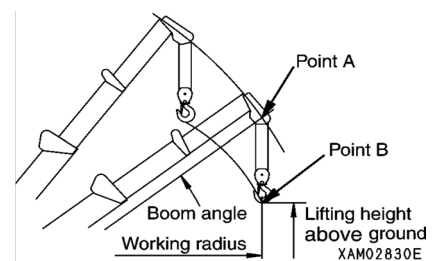

2. The "diagram of working radius and lifting height" shows the relationships between the working radius, boom angle and lifting height at no load, allowing for no deflection in the boom.

A deflection occurs in the boom when an object is hoisted, which causes the working radius to widen slightly.

The rated total load decreases with increase in the working radius. Actual crane operation requires the planning of work, allowing for sufficient clearance more than that provided in the diagram.

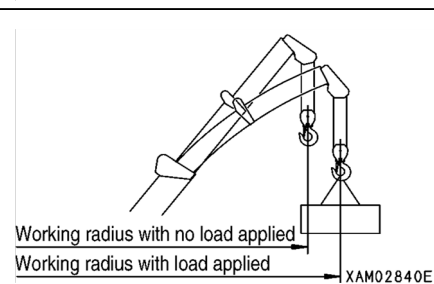



### 5.3 RATED TOTAL LOAD CHART

#### **⚠ CAUTION**

- Rated total load chart is based on level, hard ground.
- Values given in the rated total load chart are based on the working radius including the deflection of boom under actual load.
- When boom (3) is extended even for a minimal extent, perform the work within the capacity indicated in the column of "boom (3)".
- When boom (4) is extended even for a minimal extent, perform the work within the capacity indicated in the column of "boom (4)".
- When more than one-half of the "∇ mark" of boom (4) is exposed from boom (3), perform the work within the capacity indicated in the column of "boom (5)".
- If working radius exceeds the value of Working Radius column in the chart by any extent, work should be performed within the rated total load in the next column of Working Radius.
- The value of a rated total load including the mass of hoisting accessories (hook: 90 kg (applicable for 2-fall and 4-fall wire rope) or 20 kg (dedicated for Single-fall hook wire)).

**CC1485S-1 Rated Total Load Chart (4-Fall Hook)**

Working radius (m)	(1) 4.745m Boom		(2) 7.625m Boom		(3) 10.505m Boom		(4) 13.385m Boom		(5) 16.265m Boom	
	Stationary	Pick & Carry	Stationary	Pick & Carry	Stationary	Pick & Carry	Stationary	Pick & Carry	Stationary	Pick & Carry
2.00	6000	2000	6000	2000	3000	1500				
2.50	6000	2000	6000	2000	3000	1500	3000			
2.60	6000	2000	6000	2000	3000	1500	3000			
3.00	5250	2000	5260	2000	3000	1500	3000		2600	
3.20	4910	2000	4920	2000	3000	1500	3000		2600	
3.50	4450	2000	4460	2000	3000	1500	3000		2600	
3.85	4000	2000	4000	2000	3000	1500	3000		2600	
4.00	3830	1915	3820	1910	3000	1500	3000		2600	
4.50	3320	1660	3310	1655	3000	1500	3000		2600	
4.58	3250	1625	3240	1620	3000	1500	2940		2600	
4.60			3220	1610	3000	1500	2920		2600	
5.00			2880	1440	2710	1355	2640		2600	
5.50			2520	1260	2400	1200	2340		2320	
6.00			2210	1105	2140	1070	2100	Prohibited	2080	
6.50			1950	975	1920	960	1890	Prohibited	1880	
7.00			1720	860	1720	860	1710		1710	
7.46			1530	765	1570	785	1570		1580	
7.50					1550	775	1560		1560	Prohibited
8.00					1400	700	1430		1430	
8.50					1270	635	1310		1320	
9.00					1150	575	1200		1210	
10.00					940	470	1020		1040	
10.34					880	440	970		980	
11.00							880		890	
12.00							750		770	
13.00							650		670	
13.22							630		650	
14.00									580	
15.00									500	
16.00									440	
16.10									430	

SAM15410





### CC1485S-1 Rated Total Load Chart (2-Fall Hook)

Working radius (m)	(1) 4.745m Boom		(2) 7.625m Boom		(3) 10.505m Boom		(4) 13.385m Boom		(5) 16.265m Boom	
	Stationary	Pick & Carry	Stationary	Pick & Carry	Stationary	Pick & Carry	Stationary	Pick & Carry	Stationary	Pick & Carry
2.00	3000	1000	3000	1000	3000	1000				
2.50	3000	1000	3000	1000	3000	1000	3000			
2.60	3000	1000	3000	1000	3000	1000	3000			
3.00	3000	1000	3000	1000	3000	1000	3000		2600	
3.20	3000	1000	3000	1000	3000	1000	3000		2600	
3.50	3000	1000	3000	1000	3000	1000	3000		2600	
3.85	3000	1000	3000	1000	3000	1000	3000		2600	
4.00	3000	1000	3000	1000	3000	1000	3000		2600	
4.50	3000	1000	3000	1000	3000	1000	3000		2600	
4.58	3000	1000	3000	1000	3000	1000	2940		2600	
4.60			3000	1000	3000	1000	2920		2600	
5.00			2880	1000	2710	1000	2640		2600	
5.50			2520	1000	2400	1000	2340		2320	
6.00			2210	1000	2140	1000	2100	Prohibited	2080	
6.50			1950	975	1920	960	1890		1880	
7.00			1720	860	1720	860	1710		1710	
7.46			1530	765	1570	785	1570		1580	
7.50					1550	775	1560		1560	Prohibited
8.00					1400	700	1430		1430	
8.50					1270	635	1310		1320	
9.00					1150	575	1200		1210	
10.00					940	470	1020		1040	
10.34					880	440	970		980	
11.00							880		890	
12.00							750		770	
13.00							650		670	
13.22							630		650	
14.00									580	
15.00									500	
16.00									440	
16.10									430	

SAMI5420

### CC1485S-1 Rated Total Load Chart (Single-Fall Hook)

Working radius (m)	(1) 4.745m Boom		(2) 7.625m Boom		(3) 10.505m Boom		(4) 13.385m Boom		(5) 16.265m Boom	
	Stationary	Pick & Carry	Stationary	Pick & Carry	Stationary	Pick & Carry	Stationary	Pick & Carry	Stationary	Pick & Carry
2.00	1500	500	1500	500	1500	500				
2.50	1500	500	1500	500	1500	500	1500			
2.60	1500	500	1500	500	1500	500	1500			
3.00	1500	500	1500	500	1500	500	1500		1500	
3.20	1500	500	1500	500	1500	500	1500		1500	
3.50	1500	500	1500	500	1500	500	1500		1500	
3.85	1500	500	1500	500	1500	500	1500		1500	
4.00	1500	500	1500	500	1500	500	1500		1500	
4.50	1500	500	1500	500	1500	500	1500		1500	
4.68	1500	500	1500	500	1500	500	1500		1500	
4.60			1500	500	1500	500	1500		1500	
5.00			1500	500	1500	500	1500		1500	
5.50			1500	500	1500	500	1500		1500	
6.00			1500	500	1500	500	1500	Prohibited	1500	
6.50			1500	500	1500	500	1500		1500	
7.00			1500	500	1500	500	1500		1500	
7.50			1500	500	1500	500	1500		1500	
7.56			1500	500	1500	500	1500		1500	Prohibited
8.00					1400	500	1430		1430	
8.50					1270	500	1310		1320	
9.00					1150	500	1200		1210	
10.00					940	470	1020		1040	
10.44					880	440	950		970	
11.00							880		890	
12.00							750		770	
13.00							650		670	
13.32							630		640	
14.00									580	
15.00									500	
16.00									440	
16.20									420	

HYS10004E

The rated total load chart provides the maximum loads that the crane is capable of hoisting objects depending on boom length by working radius.

**[1] BOOM LENGTH**

In the Rated Total Load Chart, the "4.745 m boom (1)", "7.625 m boom (2)", "10.505 m boom (3)", "13.385 m boom (4)" and "16.265 m boom (5)" given in columns on the top denote the respective states of the following figures:

1. "4.745m boom (1)": All the booms are retracted.

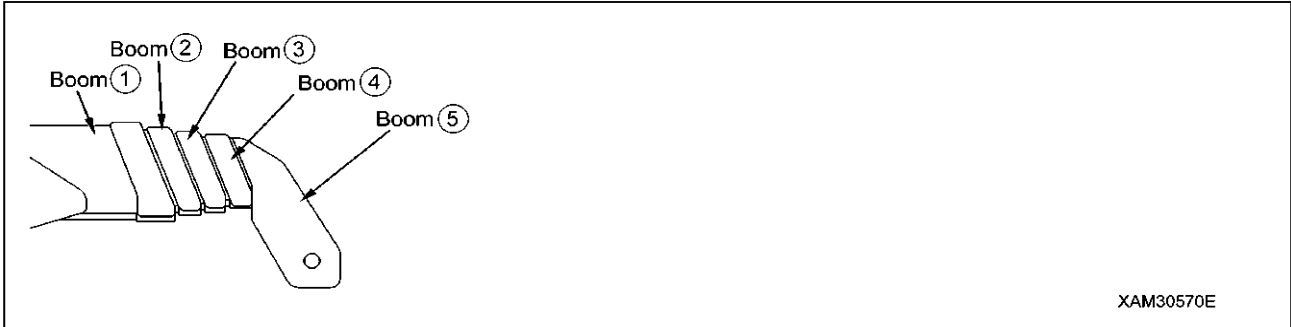

2. "7.625 m boom (2)": Booms (3), (4) and (5) are retracted, while boom (2) alone is fully extended.

If boom (2) is extended even to a small extent, perform the work in the capacity indicated in this column.

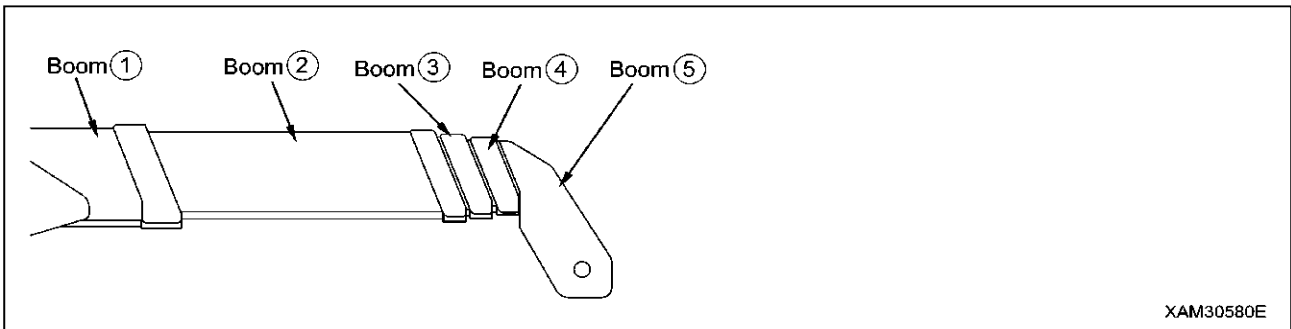

3. "10.505 m boom (3)": (4) and (5) are retracted, while booms (2) and (3) are fully extended.

If boom (3) is extended even to a small extent, perform the work in the capacity indicated in this column.

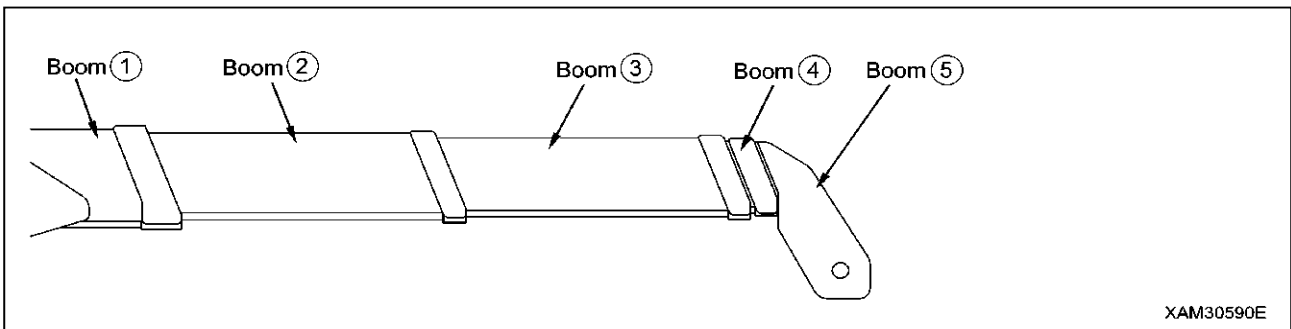

4. "13.385 m boom (4)": Booms (2) and (3) are fully extended, while booms (4) and (5) are extended to an intermediate length ( mark) is exposed half way from boom (3).  
If booms (4) and (5) are extended even to a small extent, perform the work in the capacity indicated in this column.

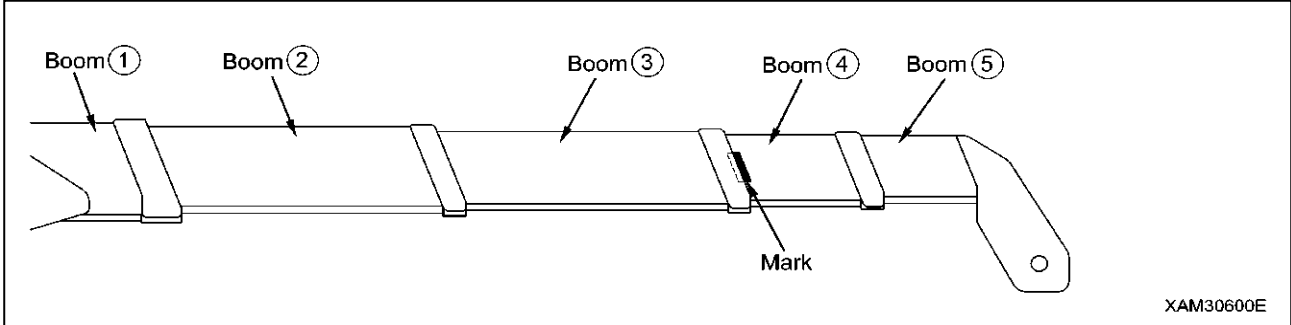

5. "16.265 m boom (5)": All the booms are fully extended.  
When more than one-half of the " mark" of boom (4) is exposed from boom (3), perform the work within the capacity indicated in this column.

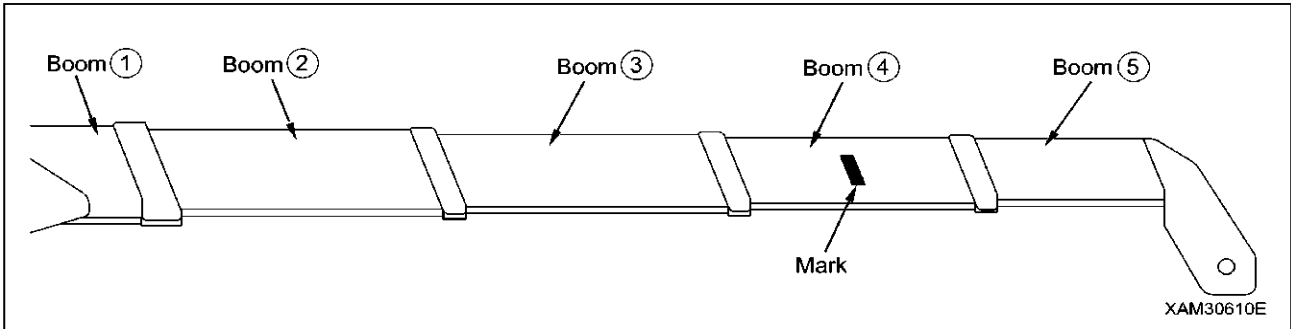





# SAFETY

1. BASIC PRECAUTIONS	14
2. OPERATION RELATED PRECAUTIONS	20
3. TRANSPORT PRECAUTIONS	37
4. MAINTENANCE PRECAUTIONS	39
5. SAFETY LABEL LOCATIONS	48

## **WARNING**

**All the safety precautions defined in this manual should always be read and observed.  
Failure to follow the safety precautions can cause serious personal injury or death.**



# 1. BASIC PRECAUTIONS

Incorrect operation and servicing may result in serious bodily accidents. Before starting operation and servicing, read this manual and safety labels to observe their warnings and precautions.

## 1.1 PRECAUTIONS BEFORE STARTING WORK

<b>OBSERVE THE MANUAL AND SAFETY LABELS</b>	
<ul style="list-style-type: none"> <li>Read well and understand this manual as well as the safety labels attached to various parts of this Machine. Attempt to drive/operate without understanding fully may result in wrong operation that may cause personal or equipment accidents.</li> <li>Fully understand the proper use and inspection/maintenance procedures, and perform the work safely.</li> <li>Make sure this manual and the safety labels attached to various parts of this Machine are legible all the time. Whenever illegibility or loss occurs, order us or our sales service agency and put the safety label back to the original location.</li> </ul>	

<b>QUALIFICATION FOR OPERATION</b>
<ul style="list-style-type: none"> <li>The operators of this machine are required to have adequate qualification. Be sure to acquire the qualification before engage in the operation.                             <ul style="list-style-type: none"> <li>★ See "INTRODUCTION 4. QUALIFICATION FOR OPERATION " for details of the operational qualification.</li> </ul> </li> <li>When performing operations using this machine, be sure to carry the "mobile crane operator's license" or the "completion certificate of skill training course for the operation of light duty mobile cranes all the time. Also, when performing a slinging operation, always carry the "completion certificate of skill training course for slinging operation".</li> <li>The operators are requested to receive education and training of the handling methods and other subjects at the office, and obtain sufficient operation skills before work.</li> </ul>

<b>COMMIT TO SAFE OPERATION</b>
<ul style="list-style-type: none"> <li>Follow the instructions and signs given by the manager and work supervisor, and observe safety first during work.</li> <li>Follow the crane work basics during work.</li> <li>Always make sure to carry out inspections before using this machine.</li> <li>Do not work under bad weather for instance strong wind, thunder or mist.</li> <li>Do not drive under any condition when you are overtired, under the influence of alcohol or after taking soporific drugs.</li> <li>Follow all of the workplace rules, safety regulations and operation method sequences during operations and inspection/maintenance.</li> <li>Pay attention to surrounding conditions and pedestrians all the time during operation. Whenever pedestrian approaches unwarily, abort the operation once, and take a measure such as issuing a warning.</li> <li>When operating, be mentally prepared for unexpected situation so that you can take measures immediately.</li> <li>Never attempt any use out of the capabilities and purposes described in this manual under any circumstances.</li> <li>Observe the designated rated total load and work range when operating.</li> <li>Never attempt inattentive driving, harsh driving or awkward operation under any circumstances.</li> <li>Pull out the key when leaving the operator's seat.</li> </ul>



## 1.2 PREPARING FOR SAFE OPERATION

### PROVIDE SAFETY DEVICES FOR SURE

- Check to ensure that all guards, covers, mirrors and rear-view camera are attached properly. Repair immediately if damaged.
- Understand how to use the safety devices well and use properly.
- Do not detach the safety devices under any circumstances. Keep control to achieve proper function all the time.
- Improper use of the safety devices may lead to serious accidents.
- Do not rely too much on the safety devices whilst operating.

### PREPARE FOR ABNORMALITY

- Make sure to carry out inspections and maintenances, and make an effort to prevent accidents before happening.
- Whenever you feel an abnormality in the Machine, abort the operation immediately, ensure safety and report to the manager.
- Assign in advance who takes which solution to prevent secondary accident.
- Never operate the Machine when fuel or hydraulic oil is leaking from the Machine. Report the manager about the abnormality, and repair the leaking point of the fuel/hydraulic oil completely before use.  
The fuel for this Machine is diesel fuel. Be especially careful for the presence of fuel leak.
- Before leaving the Machine, lower the hoisted load to the ground, stop the engine and pull out the starter key.



A0055020

### TEMPORARY STORAGE WHEN ABNORMALITY IS FOUND WITHIN MACHINE

- In case the Machine is found with an abnormality and is therefore stored temporarily waiting for service, apply following measures to notify all persons in the office that "the use is prohibited due to failure."
- Put on warning tags on the operation lever and other applicable parts.  
Write clearly the information such as abnormality contents, name and contact of the storage manager, and the term of storage.
  - Keep it immovable when parking by, for instance, putting the blocks on the rubber tracks as pawls.
  - Pull out the engine key and keep it with you.

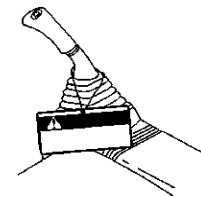

AE305910

### WEAR PROTECTIVE EQUIPMENT AND CLOTHES SUITABLE FOR WORK

- Always put on a helmet, safety shoes and safety belt.
- Make sure to wear the necessary protective equipment suitable for the relevant working condition.
- Do not wear loose garments or accessories as these may get caught on an operation lever or any protrusions which could lead to unexpected movement of the Machine.

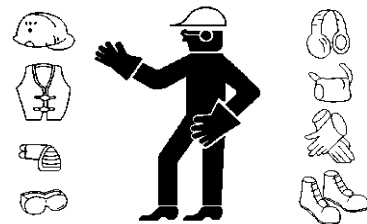

A0055010



**USE OF MACHINE THAT WAS RENTED OR PREVIOUSLY USED BY SOMEONE ELSE**

Check the following subjects in writing before using any Machine that was rented or previously used by someone else.

In addition, check the inspection record table for the maintenance conditions such as the periodic inspections.

- (1) Crane capacity
- (2) Crane maintenance conditions
- (3) Behaviors and disadvantages unique to the crane
- (4) Other subjects that require attention while operating
  - (a) Operating condition of the brakes, clutch and others
  - (b) Presence/absence and lighting condition check-up of lighting and rotating lamps
  - (c) Operating condition of hook, winch, boom and others

**ALWAYS KEEP THE MACHINE CLEAN**

- If the Machine remains contaminated with soil, sand, oil and grease, it may cause slipping, tripping or tumbling when getting on the Machine or maintenance servicing. Thus, wipe off the soil, sand, oil and grease sticking to the Machine to keep it clean all the time.
- When washing the machine with water or cleaning it with steam, prevent its electrical devices from being directly splashed with water. Water entering the electrical system is dangerous and will cause electrical devices to malfunction resulting in faulty or improper operations. If the Machine malfunctions, it may behave unexpectedly, resulting in serious injury.

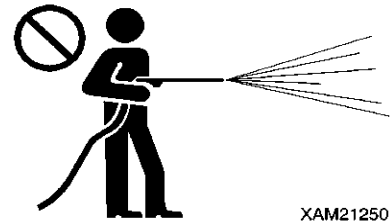

XAM21250

**CLEAN AND TIDY UP THE OPERATOR'S CABIN.**

- Before getting in the cabin, wipe off shoe soles to remove dirt, oil and grease. Stepping on the pedals with shoes that are contaminated with dirt, oil and grease may cause slipping, resulting in an accident.
- Do not leave parts or tools in the operator's cabin. The parts and tools left in the cabin may cause unexpected actions, resulting in serious injury.
- Do not attach suction cups to the window glass. It may work as a lens to cause fire.
- Do not bring any dangerous substances (such as combustibles and explosives) in the cabin.
- Do not use a mobile phone during running or operating. It may disturb operations, resulting in serious injury.

**PROVISION OF FIRE EXTINGUISHER AND FIRST AID BOX**

Always observe the following to prepare for injuries and fires.

- To prepare in case of fire, decide on a location and install a fire extinguisher, and make sure to read the label for terms of usage.
- Decide the location to store the first aid box. In addition, inspect the first aid box periodically and replenish the contents as necessary.
- Decide the measures to take upon an injury or fire accident.
- Decide how to contact the emergency address (for instance the emergency physician, ambulance or fire department), and put up the contact address at designated position so that anyone can make the contact.

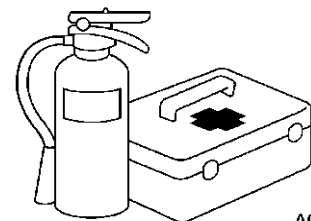

A0055070



## 1.3 PRECAUTIONS FOR FIRE PREVENTION

### WHAT TO DO IF A FIRE OCCURS

- Turn the starter switch OFF to stop the engine.
- Get out of the Machine by using a handrail and steps.
- Do not jump off the Machine. You may fall and get hurt.

### PREVENTING FIRE

#### • Fire caused by fuel, oil, anti-freezing fluid, or wind-washer liquid

Attempt to let a fire approach the fuel, oil, anti-freezing fluid, or wind-washer liquid may result in catching fire. Strictly observe the following.

- Do not smoke or use fire near the machine.
  - Before refueling, be sure to stop the engine.
  - Do not leave the site when replenishing the fuel or oil.
  - Close and securely tighten the cap of fuel tank and hydraulic oil tank.
  - Do not spill fuel on an overheated surface and parts of electric system.
  - After refueling, cleanly wipe off spilt fuel and oil.
  - Put rags and other combustibles smeared with oil in a safe container and store it in a safe place.
  - Use incombustible cleaning oil for the objects such as the components, and do not use diesel fuel, petrol or anything else that may catch fire.
  - Do not weld or gas flame-cut piping and tubing containing flammable solutions.
  - Store the fuel and oil in a specified well-ventilated location and prohibit public access.
  - Before performing grinding or welding of the Machine, move inflammables to a safe place.
- #### • Fire due to deposition or adherence of combustibles.
- If any of such combustibles as dead leaves, chips, paper litters, and charcoal dust is deposited on or sticking to the peripheral area of engine exhaust manifold, muffler, battery or under-cover, remove it.
  - To prevent fire caused by bonfire sparks or other types of fire that can be caught, remove such combustibles as dead leaves, chips, paper litters, and charcoal dust that may be deposited on or sticking to the peripheral area of cooling units (radiator and oil cooler).
- #### • Fire originating from electric wiring
- Fire may be incurred by a short-circuit of electric system. Strictly observe the following.
- Keep every connection of electric wiring clean and fix it securely.
  - Check for any loosening or damage of electric wiring on a daily basis, and if any loosened connector or wiring clamp is found, retighten it and repair or replace any damaged electric wiring.
- #### • Fire originating from piping
- Check the clamps and cushions of each hose and tubing to ensure that they are securely fixed. Any loosening may give rise to vibration during operation, rubbing with other parts to damage hose, or spouting of high pressure oil, resulting in fire or physical injury.
- #### • Explosion triggered by lighting fixture
- When inspecting fuel, oil, battery electrolyte and coolant water, use a lighting apparatus of explosion-proof specifications.
  - When disconnecting power source from the Machine, follow the instructions described in this manual.



A0055020



A0055040



A0055160



## 1.4 CAUTIONS IN GETTING ON AND OFF THE MACHINE

### USE A HANDRAIL AND STEPS WHEN GETTING ON AND OFF THE MACHINE

When getting on and off the Machine, be sure to observe the following precautions in order to prevent physical accidents such as slipping and falling or tumbling.

- Use the arrow-marked handrails and steps shown in the figure at the right when getting on and off the Machine.
- When getting on and off the Machine, always face the machine, allow the three parts of limbs (both feet and a hand, or a foot and both hands) to come into contact with the hand rails and steps to hold your body.
- Before getting on and off the Machine, check the handrails and steps for any damage or loosening, and for any oil or dirt sticking to the Machine surface. When oil or dirt is deposited, do not fail to thoroughly clean it so that the surface is not slippery. Repair any damage and retighten any loosened bolt.
- Do not grasp operating levers and locking levers when getting on and off the Machine.
- Never step on the engine hood and cover that are not treated with anti-skidding coating.
- Do not get on or off the machine while holding a tool in hand.
- Do not jump on or off the Machine. Also, do not get on or off the moving Machine.
- Even if the Machine unexpectedly begins to move unattended, never jump on it to stop it.

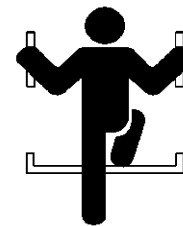
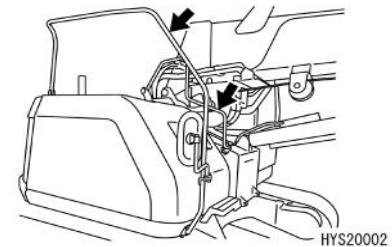
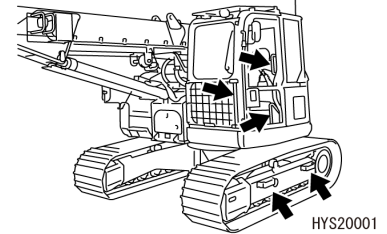

XAM06380

### CAUTIONS IN STANDING UP FROM THE OPERATOR'S SEAT OR LEAVING THE MACHINE

- Before standing up from the operator's seat for opening or closing the front or ceiling window, detaching or attaching the lower window, or adjusting the operator's seat, be sure to retract the crane and set the lock lever (1) to "LOCK" position (L) and stop the engine. Inadvertently touching operating levers may cause the machine to suddenly move and invite serious injury.
- When leaving the Machine, be sure to retract the crane, set the lock lever (1) to "LOCK" position (L), and stop the engine. Also apply every lock, be sure to bring the key back, and store it in a specified place.

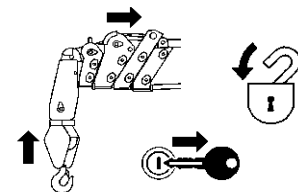
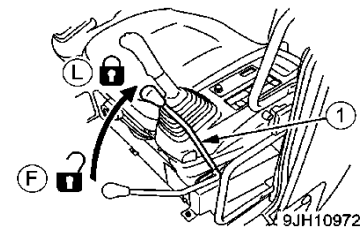

XAM14541

### EMERGENCY EXIT OF THE OPERATOR'S CABIN

- If by any chance, the cabin door fails to open, use the provided hammer to break the window glass and escape through the opening.
- Before getting out, remove the broken fragments of glass from the window frame to avoid getting hurt. Also, watch your step not to slip on broken fragments of glass.

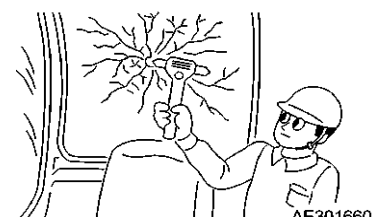

AE301660





## 1.5 OTHER PRECAUTIONS

### CAUTION AGAINST BEING CAUGHT

In the periphery of the upper slewing body and crane unit, the clearance varies with the motion of derricking cylinder and winch. If being caught in it, serious injury may occur. Keep persons away from all rotating and telescoping sections.

Never allow your body or part of it to get in the following gaps:

- Between the boom and the upper slewing body
- Between the boom and the derricking cylinder
- Between winch drum and wire rope
- Between each sheave and wire rope

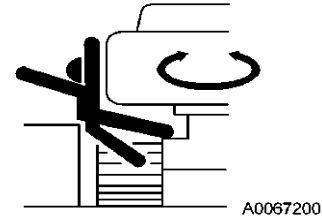

### REMODELING THE MACHINE IS PROHIBITED

Do not remodel the Machine without our written consent under any circumstances. Particularly, partial welding of the Machine may damage the safety device.

The remodeling raises a safety issue, so consult us or our sales service agency beforehand. We cannot be held responsible for any personal injury or failure caused by remodeling the Machine that was performed without consulting us.

### CAUTIONS ON ATTACHMENTS AND OPTIONAL UNITS

- We cannot be held responsible for any personal injury, failures or property damage of attachments and optional units that are not recognized by us.
- Installing an attachment or optional units may give rise to safety and legal issues, and thus the customer is kindly requested to consult with us or our sales service agency beforehand.
- Depending on the combination of attachments and optional units they may cause interference with operating cabin and machine parts. Interference with the Machine during operation may cause serious injury. Check to ensure that the attachments and optional units to be used would interfere with the Machine, and use them within the interference-free range.
- Never fail to read the descriptions on the attachments and optional units given in the instruction manual of the installed attachment as well as this manual.

### CAUTIONS ON THE CABIN GLASS

- If the cabin glass is broken, immediately stop operation and have it repaired.
- When the ceiling window is scarred, the visibility is spoiled and probability of breakage rises. Replace the scarred ceiling window glass at an early stage. Leaving the scars increases the risk of breakage by any object falling onto the ceiling window, resulting in injury.

### CAUTIONS ON RUNNING THE ENGINE INDOORS

To prevent the risk of petrol poisoning from starting the engine/handling fuel and cleaning oil/painting indoors or at a location with bad ventilation, open the windows and exit doors.

If the ventilation is insufficient even after opening the windows and exit doors, set up a ventilation fan.

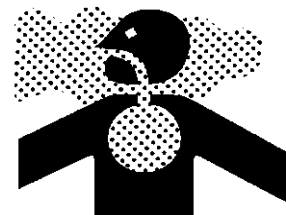

A0055060



## 2. OPERATION RELATED PRECAUTIONS

### 2.1 PRECAUTIONS ON WORK SITE

#### **SURVEY AND SAFETY ASSURANCE OF WORK SITE**

A number of risks that may cause serious injury are imbedded in a work site. Before starting work, check the following matters beforehand to ensure that no danger is present at the worksite:

- When working near straw-thatched roofs, dead leaves or dead grass, beware of those fire-catching object.
- Investigate the ground and road surface condition of the worksite and decide the best working method. At a site where risk of landslide or rock fall exists, do not operate the Machine.
- Flatten the inclination of the worksite before starting work.
- When working over the roadway, enforce "keep out" by, for instance, assigning guides or surrounding the site by barriers, and ensure the safety of the traffic vehicles and pedestrians.
- Enforce "keep out" to prevent people from entering the worksite and apply measures to prevent people from approaching. Attempt to approach the moving Machine may result in pinching or hard collision by contact, and may result in serious accidents and deaths.
- When running on a shallow bottom stream or weak ground, examine the water depth, water flow velocity as well as ground condition and land features in advance in order to avoid hazardous place for traveling and operation.
- The ground of a zone adjacent to a cliff, road shoulder, and deep ditch is likely to be loosened, and thus it should be avoided for running and performing operation. The ground in such a zone may be collapsed by the mass and/or vibration of the Machine, which may trip or fall. Be especially careful after rain, use of dynamite, or earthquakes, as the ground will be unstable.
- The ground of an area near an earth fill or in the vicinity of a dug gutter may be collapsed by the mass and/or vibration of the Machine, resulting in the trip or fall of the Machine. Before starting operation, take necessary measures to make the ground intact and safe.

#### **SECURING VIEWS**

This Machine is equipped with such devices as mirror and rear view camera that provide improved views. Though some areas can hardly viewed from the operator's seat, and thus be cautious in operation.

Running and operating in places with poor visibility prevent the operator from detecting hazards around the Machine and recognizing work site status, and thus may cause serious injury.

When running and operating the Machine in place with poor visibility, strictly observe the following:

- If adequate view cannot be secured, deploy personnel as a marshaller as required. In that case, limit the number of signaling marshaller to one person.
- In a dark place, turn on the working light and head lamps equipped with the Machine, and use additional lighting devices as required to light up the work site.
- When visibility is spoiled by fog, snow, rain or sand dust, stop the operation.
- If the mirrors mounted on the Machine are contaminated, clean them and adjust the field of view to secure visibility.
- If the rear view camera is contaminated, clean the lens to secure clear vision around the periphery.

#### **RECOGNIZING THE SIGNAL OF MARSHALLERS AND STREET SIGNS**

- To ensure the identification of weak road shoulder and ground, install sign boards. Further, for a place with poor visibility, appoint marshaller as required. In that case, limit the number of signaling marshaller to one person.

The operator should pay attention to sign boards and follow the marshaller's instructions.

- All the personnel involved should understand the meaning of every signal, sign and sign board.





**BEWARE OF ELECTRICAL CABLE ABOVE**

- Do not let the Machine touch the electrical cables above. High voltage cables may also inflict electrical shock by close proximity.
- Slings operators are likely to suffer electrical shocks. Always observe the following to prevent accidents.
  - If the boom or the wire ropes may contact an electrical cable in the workplace, consult the electricity company and make sure that the measures (for instance placement of a guard personnel or application of wrap tubes and warning tags to the electrical cable) stipulated by the related regulations are taken before starting work.
- Put on rubber soled shoes and rubber gloves, and be careful that the body parts unprotected by rubber or other insulation do not contact the wire rope or the Machine frame.
- Place a guide and let him/her watch so that the boom, wire rope or Machine frame does not go near the electrical cable too much. Before doing so, decide the emergency signs and other necessities.
- Ask the electricity company for the voltage in the electrical cables at the worksite.
- Secure the separation (safe distance) shown in the following table between the boom/Machine frame and electrical cables.

	Voltage of Electrical Cable	Minimum Safe Distance
Low voltage (Distribution line)	100/200V	2m
	6,600V	2m
Special voltage (Transmission line)	22,000V	3m
	66,000V	4m
	154,000V	5m
	187,000V	6m
	275,000V	7m
	500,000V	11m

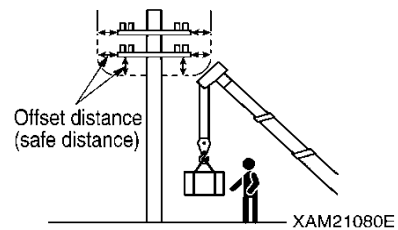
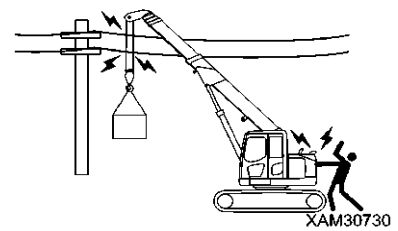

**MEASURES WHEN CHARGE ACCIDENT OCCURS**

- If a charge accident occurs, react calmly and take measures in the following procedure.
- 1. Report**  
Immediately report to the electricity company or related management company, and receive instructions for the power transmission stop, emergency procedures and related matters.
  - 2. Evacuation of related personnel from vicinity of Machine**  
Evacuate all personnel, including workers, from the vicinity of the machine to prevent secondary disasters.  
Personnel who suffered electrical shock by holding a sling rope, guide rope or other conductor when the Machine was charged should evacuate by his/her own effort.  
Do not try to help personnel affected by electric shock. Otherwise, secondary electrical shock accident will occur.
  - 3. Emergency procedure**  
In the case of personnel receiving an electric shock due to the machine being electrically charged, do the following:
    - (1) If the machine is operational, immediately move it to a safe location away from the cause of the electrical charge. Take care not to break or disrupt the distribution power cable.
    - (2) Move the machine to a safe location, and after making sure the machine is not electrically charged, take the affected personnel to the hospital.
  - 4. Measure after accident**  
After the accident, do not reuse as is. Such attempt may cause unexpected accidents and enhances failures.  
Ask us or our sales service agency for repair.



**CAUTIONS WHEN OPERATING CRANE IN LOCATION WITH HIGH OUTPUT MICROWAVE EMISSION**

Operating the crane near high output microwave emission equipment such as a radar or TV/radio broadcast antenna causes the crane construction to be exposed to the microwave and generates induced current, therefore is very dangerous. In addition, the mechatronics may become haywire.

Establish grounding between the Machine frame and the ground when working in such location. In addition, slinging operators are requested to wear rubber boots and rubber gloves since risk of electrical shock by contacting parts such as the hook or wire exists.

**BEWARE OF ASBESTOS DUST**

Inhalation of asbestos dust may result in lung cancer. This Machine does not contain asbestos, but asbestos may be found in the wall, ceiling or other construction locations within the worksite of this Machine. In addition, be careful of the following when working with a material that may contain asbestos.

- Put on designated dust free mask and/or other protection equipment where necessary.
- Do not use compressed air for cleaning.
- Spray water when cleaning to prevent airborne asbestos dust.
- Always work at windward location when operating the Machine at a site that may contain asbestos dust.
- Do not allow unauthorized personnel to approach the work site.
- Strictly observe the assigned rules related to the worksite and environmental standard.



A0055060

## 2.2 CAUTIONS WHEN STARTING ENGINE

### PAY ATTENTION TO WARNING SIGNS

When warning sign "DANGER. DO NOT OPERATE!" is put up, the Machine is being inspected and under maintenance. Do not start the engine and refrain from touching operating levers. Disregarding the warning sign to operate the Machine may give rise to the danger of involving the preparing personnel into the rotating parts or movable parts of the Machine, resulting in serious injury.

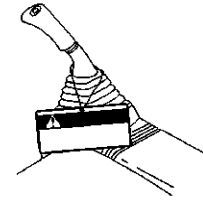

AE305910



### INSPECTING AND ADJUSTING BEFORE STARTING ENGINE

Before starting engine at the beginning of the day, perform items under "Operations 3.1 PRE-OPERATION INSPECTION" and conduct the following inspections. Omitting these inspections may cause serious bodily accidents.

- Never fail to execute the inspection before starting work.
- Remove the contamination on the window glass surface to secure good view.
- Clean the lens surface of head lamps and working lights and ensure that they are properly lit.
- Check the coolant water level, fuel level, engine oil pan level, air cleaner for any clogging and electric wiring for any damage.
- Adjust the operator's seat to the operator's posture for easy work. Also, check seat belts and their mounting fixtures for any damage or abrasion.
  - ★Refer to the descriptions under "OPERATION 3.1.2 [11] ADJUSTING THE OPERATOR'S SEAT".
- Adjust the mirrors to the best position for commanding a good view of rear scene and the drum from the driver's seat.
  - ★Refer to the descriptions under "OPERATION 3.1.2 [12] ADJUSTMENT OF MIRRORS".
- Adjust the rear view camera to the best angle to check the image on the monitor display and command a good view of the scene in the rear.
  - ★Refer to the descriptions under "OPERATION 3.1.2 [14] ANGLE ADJUSTMENT OF REAR VIEW CAMERA".
- Check pedals for any dirt or foreign matter deposited on their movable parts and ensure that they can function satisfactorily.
- Check instruments to ensure that they function properly and each of the operating levers is in its neutral position.

Always repair if any result of the above is faulty.

### CAUTIONS BEFORE STARTING ENGINE

- Make sure nobody is on or under the Machine and in its vicinity and nobody or no hazard is found within the boom slewing range.
- Do not allow anyone other than the operator to get on the Machine.
- Start the engine only when the operator is sitting on the operator's seat.
- Check to ensure that each of the operating levers is in its neutral position.
- Check to ensure that lock lever (1) is in the "LOCK" position (L).
- Honk the horn for warning before starting the engine.
- Do not start the engine by short-circuiting the starter circuit. This may cause a fire.

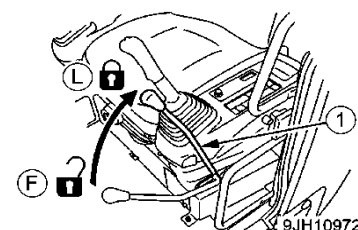

9JH10972

### CAUTIONS UNDER COLD WEATHER

- Remove snow from and defrost the surface of the slewing gear, boom and around winch, and ensure that their movements before starting work.
- Before starting the engine, ensure that the automatic glow lamp goes off.
- Operating the Machine without sufficient engine warm-up causes slow response of the Machine to the operation of levers and pedals, and thus unexpected motion may occur against the operator's will. Do not fail to execute the engine warm-up. The engine requires an adequate warm-up time especially in cold climates.
- When the battery electrolyte is frozen, do not recharge the battery or start the engine with another power source. Such act may cause the battery to catch fire or explode. Defreeze the battery electrolyte and check for fluid leak before re-charging or starting the engine by using another power supply.
- After end of the work, wipe off and put on a cover if substances such as condensation, snow or mud are stuck to the wire harness, connector(1), switches, sensors or similar part. If the infiltrated condensation and/or similar substance freeze, the Machine may operate improperly upon the next use and cause unexpected accidents.

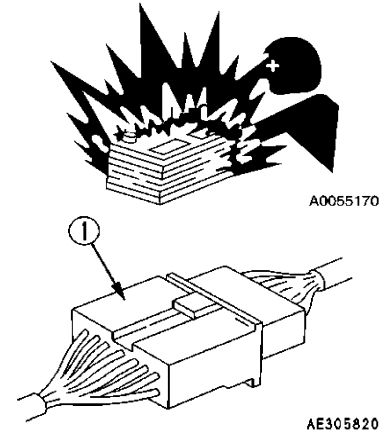

### CAUTIONS WHEN STARTING UP USING BOOSTER CABLE

Wrong booster cable connection method may result in fire, so always observe the following.

- When using a booster cable for engine start, perform the 2-person operation by one person on the operator's seat and another on the battery side.
- When starting the engine using other Machine, be careful to prevent contact between the normal Machine and broken Machine.
- Keep the starter switch key of both the normal Machine and the broken Machine in "OFF" position when the booster cable is connected.
- Do not connect to wrong side [connecting (+) to (-), (-) to (+)] when connecting the booster cable.
- Start connecting from (+) terminal first, but start disconnecting from (-) terminal (ground) first.
- Connect the ground to the (-) terminal of the broken Machine when connecting the ground as the last procedure.
- ★ Refer to the description under "OPERATION 8.3.4 STARTING ENGINE WITH BOOSTER CABLE".
- Avoid contact between clips of the booster cable, and contact between a clip and the Machine when disconnecting the booster cable.

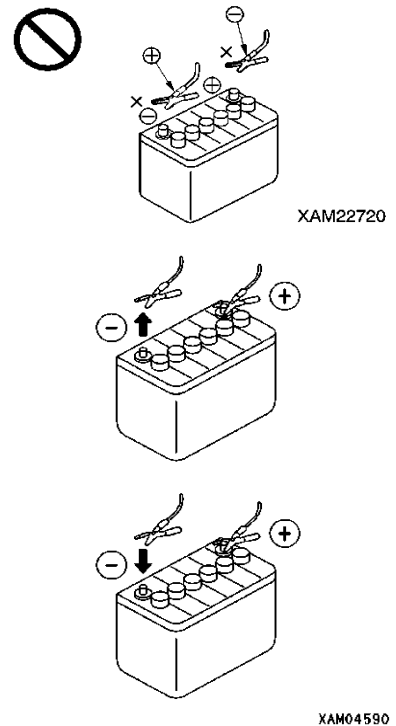



## 2.3 PRECAUTIONS FOR STARTING CARRIER AND OPERATING CRANE

### INSPECTION BEFORE STARTING OPERATION

Omitting the inspections after starting the engine results in delay to discover the Machine abnormalities, and may result in accidents and Machine damages.

Inspection should be carried out in a clear area. No unauthorized persons should be able to approach the Machine.

- Ensure that motion of the Machine coincides with the indication of pattern card.
- Check the operation status of devices, running status of the Machine, winch wind up/down, boom derricking, and crane operating status such as telescoping and slewing.
- Inspect the sound, vibration, heat and odour of the Machine, and check for instrument errors, air leaks, oil leaks, fuel leaks, water leaks and other bad factors. Be especially careful for the fuel leak.
- Always repair broken part whenever an abnormality is found. Attempt to use without servicing may result in unexpected accidents and/or Machine failures.

### CAUTIONS ON MACHINE FORWARDING/REVERSING AND SLEWING

Always observe the following to prevent serious injuries and accidental death when moving the Machine.

- Set the Machine to the travelling posture in the right figure. Do not allow the machine to travel without retracting the hook block.
  - Before traveling, move the sprocket to the rear of the machine. Leaving the sprocket in front of the Machine causes the direction of actual running to be in reverse of the running lever, and thus the Machine may move toward undesired direction, resulting in serious bodily accidents.
- Make sure the boom is fully lowered and retracted.
- When moving the Machine for a short distance, fix the hook block in the retracting position at the tip of the boom. When moving it for a long distance, fix the hook block to the hook holder at the front end of the upper slewing body.
- ★Refer to the descriptions under "OPERATION 3.7 MACHINE TRAVELLING POSTURE".
- Keep the door and window of operator's cabin always fixed either open or closed. Nevertheless, when being in such an area where any flying object may come into the cabin, be sure to keep them closed.
- If any person is staying around the Machine, they may come into contact of the Machine or may be caught by it, resulting in a serious bodily accident.

Before starting to move, strictly observe the following:

- Operate the Machine only when the operator is sitting on the operator's seat.
- Do not fail to wear the seat belt. Otherwise, the operator may be forced to jump out of the cabin because of an emergency braking, resulting in injury.
- Make sure to check around again so that no one or no object is in the vicinity before starting to move.
- Before starting to move, be sure to honk the horn to warn people around the Machine.
- When running, check to ensure that the traveling alarm sounds normally.
- When there is a view-obstructing range in the rear of the Machine, appoint a marshaller to ensure that no contact accident will occur and slew the machine by paying adequate attention.

Even if the Machine is equipped with mirrors and the rear view camera, be sure to appoint a marshaller.

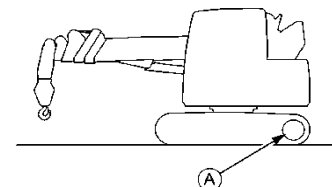

XAM14561

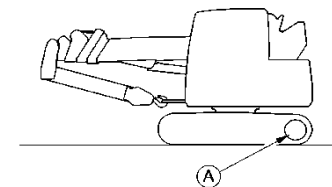

XAM14690

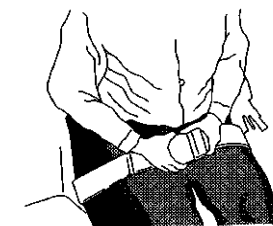

AFR05200

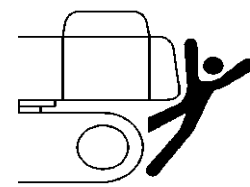

A0067190

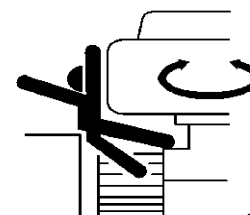

A0067200

### CAUTIONS WHEN TRAVELLING

Always observe the following to prevent serious injuries and accidental death when moving the Machine.

- Set the Machine to the travelling posture in the right figure.
  - ★ Refer to the preceding subsection "CAUTIONS ON MACHINE FORWARDING/REVERSING AND SLEWING".
- Do not attempt looking sideways or other dangerous act when driving.
- Do not over speed, start moving/stopping/slewing suddenly, or meander since such acts are dangerous.
- During traveling, keep an adequate distance from persons, structures and other machines to prevent any contact accident.
- When running on a rough terrain or a steep slope, be sure to turn the automatic deceleration switch OFF (for cancellation). Operating the Machine while the switch is turned ON raises the engine revolution speed, and the vehicle speed may suddenly be increased.
- Avoid moving over any obstacle. Travel as slowly as possible when moving over an obstacle for unavoidable reason. Since the Machine tends to tumble more easily in the lateral direction rather than in the longitudinal direction, never attempt to move over an obstacle that will cause the Machine to inclined to leftward or rightward.
- When traveling on a rough terrain, keep the vehicle speed at low level to avoid tumbling and also avoid any abrupt change of traveling direction. Such may cause the Machine to lose balance or damage the Machine or nearby object.
- When running on a bridge or crossing over a structure, check the withstand strength of the bridge or viaduct against the Machine mass beforehand. Further, when running on a public road, check with the competent authorities and follow their instructions.
- When operating the Machine in a place where machine height is restricted such as in a tunnel, in a building, under an overpass or cables, pay close attention to prevent the Machine and crane from coming into contact of those objects and operate the Machine slowly.

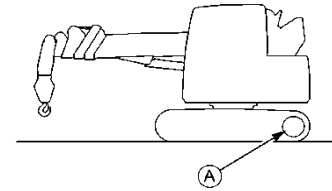

XAM14561

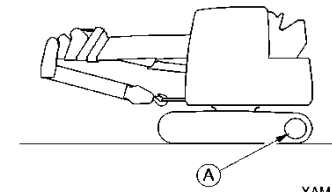

XAM14690

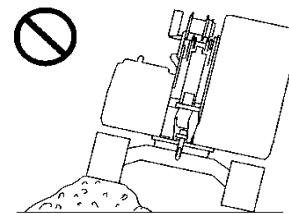

XAM14581

### BE CAREFUL WHEN TRAVELLING OVER SLOPE

Always observe the following to prevent serious injuries and death accidents when travelling over a slope for unavoidable reason.

- When running on a slope, be sure to store the hook block in the hook holder at the front end of the upper slewing body to form a running posture. Any simplified fixation of the hook at the tip of boom gives rise to the risk of loosening during running.  
Refer to the descriptions under "OPERATION 3.7 MACHINE TRAVELLING POSTURE " for the travelling posture of the Machine.
- When running on a slope having an inclination of 10 degrees or more, climb the slope in the reverse direction and run downhill in the forward direction. Thus, always allow the Machine front to face the valley when running on a slope. Climbing the slope in the forward direction and going downhill in the reverse direction cause the Machine to be unstable, giving rise to the risk of tumbling or lateral skidding.
- When running on an inclined terrain, direct the machine perpendicular to the slope and never change the direction on the slope or drive parallel to the slope.  
Practice safe travelling by for instance lowering to the plain land and divert.
- Always keep such condition during running that the Machine can stop any time when it slips or becomes unstable.
- When running downhill, lower the engine revolution and set the running lever close to the neutral position and run in a low speed.
- When running on a ground covered with grass and leaves or on a wet steel plate, keep the speed to minimal. If the ground in such condition is inclined only slightly, it is extremely slippery.
- If the engine comes to a sudden stop, immediately return each operating lever to its neutral position, and then restart it.

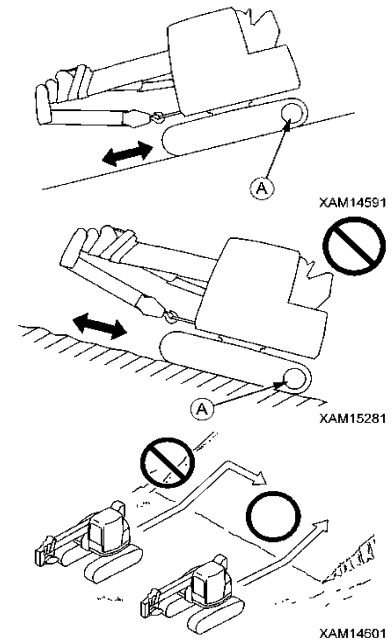





### BE CAREFUL OF TRIPPING ON UNSTABLE GROUND

Always observe the following to prevent serious injuries and death accidents when travelling over an unstable ground for unavoidable reasons.

- Do not enter soft ground area. The machine may get stuck.
- The ground near cliff, roadside and deep gully is unstable, so avoid going near such ground as much as possible.

The Machine may trip or fall when the ground loosens due to mass and/or vibration of the Machine. Be especially careful after rain, use of dynamite, or earthquakes, as the ground will be unstable.

- Avoid going near the earth fills or vicinity of dug gutter that are instable.

Crumbles caused by mass and/or vibration of the Machine may cause the Machine to tilt.

### CAUTIONS WHEN TRAVELLING SNOW COVERED OR FROZEN GROUND

Always observe the following to prevent serious injuries and death accidents when travelling over snow covered ground or frozen road for unavoidable reason.

- The snow covered grounds and frozen roads cause slips even when the inclination is small, so decrease the speed when travelling and avoid sudden starting/stopping/slewing. Uphill and downhill are especially likely to cause slips and thus dangerous.
- Frozen ground tends to be weak with the increase of atmospheric temperature, and may cause the Machine to tumble or obstruct the operator to get off. Be very careful.
- Moving into an area covered with deep snow may cause the Machine to tumble or dive into the snow. Be cautious of erroneously deviating outward from the road shoulder or driving into a snow drift.
- Running on a snowbound site may encounter the risk of tumbling or collision because of an invisible road shoulder or snow-covered installations. Be very careful.
- Refrain from directly touching metal surface with your hands or fingers in cold and harsh weather conditions.

Touching metal surface may result in skin freezing to the metal surface.

- Remove snow and/or ice laid on the Machine that causes the safety nameplates to be hard to read. Be especially careful to securely remove those that are on the boom and thus may fall.

### CAUTIONS WHEN PARKING

- For parking, select an area with flat and solid ground.
- For parking, select an area without the risk of landslide, rock fall and water submersion.
- When parking, set the Machine to the "traveling posture" as shown in the figure at the right.
  - Make sure the boom is fully lowered and retracted.
  - When parking the Machine for a short period of time, fix the hook block in the retracting position at the tip of the boom. When parking for a long time, fix the hook block in the hook holder at the front end of the upper slewing body.
- When inevitably stopping the machine on an inclined area, strictly observe the following:
  - Make sure the boom is fully lowered and retracted.
  - When parking the Machine for a short period of time, fix the hook block in the retracting position at the tip of the boom. When parking for a long time, fix the hook block in the hook holder at the front end of the upper slewing body.
  - Direct the boom toward the valley.
  - To keep the Machine immobile, apply a block as a chock.
- When leaving the Machine, strictly observe the following:
  - Set the lock lever (1) to "LOCK" position (L), and stop the engine.
  - Be sure to close the cabin door, and apply every lock. Do not fail to remove the starter key to prevent the Machine from operated by other personnel without approval, and keep it in a specified place.

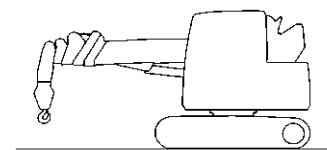

XAM14570

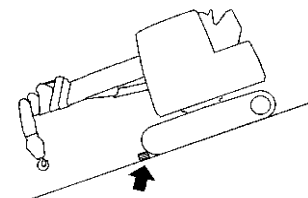

XAM14610

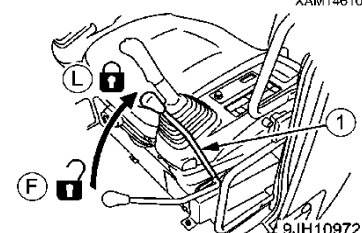

9JH10972





## 2.4 CAUTIONS DURING CRANE OPERATION

### INSPECTION BEFORE STARTING WORK

Check that the safety devices and crane operate properly.

- Operate each of the operation levers, pedals and switches under no load, and check that operations take place without any abnormality.  
Repair immediately if any abnormality exists.
- Check such safety devices as moment limiter (overload prevention device), over winding prevention device and over-unwinding prevention device to ensure that they function normally.

### CAUTIONS WHEN SETTING MOMENT LIMITER

- In the moment limiter, the moment is calculated on the assumption that the machine is placed horizontally.  
If crane work is performed without the machine being placed horizontally, no forecast or warning is issued even when the rated total load is approached.  
Never fail to check the inclination of the Machine by using the level on monitor.
- When using the moment limiter, check to ensure that the indicators of boom angle, boom length and actual load are interlocked with the crane motion to give correct values. If the crane is used with no correct indication given, correct measurement results cannot be obtained, causing serious physical injury due to tumbling or damage of the machine.
- When using the moment limiter, be sure to check that the setting of wire falls of the moment limiter matches the wire falls of the crane. If the number of falls does not match each other, either alter the setting of wire fall count moment limiter or alter that of crane so that the count matches each other. Using the moment limiter without matching its number of falls may cause the breakage of wire rope, resulting in a serious bodily accident.
- Do not change the setting carelessly during measurement with the moment limiter. Otherwise, correct measurement results cannot be obtained, causing serious physical injury due to tumbling or damage of the machine.

### CAUTIONS FOR SELECTING A PLACE TO INSTALL

Always place the Machine on a level, stable and solid ground.

It is dangerous to install on any of the following places:

- Simple asphalt pavement
- Thin concrete pavement
- Flagstone pavement
- Areas where under the pavement surface is hollow due to water erosion and the top soil appears to be hard but soft in the ground
- Soft ground near a road shoulder or dug hole
- Slope



### CAUTIONS WHEN WORKING ON A SLOPE

When inevitably perform operation on a slope, provide an earth fill (B) to create a horizontal, solid and strong footing for installing the Machine in order to prevent it from tumbling. Attempting a diagonal hoisting without ensuring the horizontal installation of the Machine not only disturbs the normal functioning of the moment limiter (overload prevention device), but also affect the Machine with an unexpected force, resulting in tumbling or damage of the Machine.

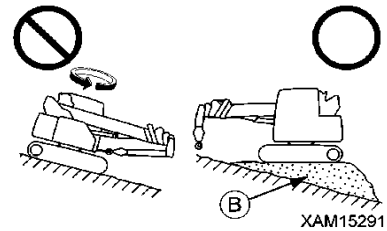

### FOLLOW INSTRUCTIONS AND SIGNS WHEN WORKING

- When operating the crane, appoint a work supervisor and mutual signs beforehand, and follow the work supervisor and signs during operation.
- When operating at a driver's blind spot, especially follow the instructions and signs of the work supervisor and operate with caution.
- When operating the crane, there is a danger of colliding with slewing boom and upper slewing body and of the gaps between movable parts of the derrick cylinder that may catch body parts such as your arm or finger. The operator is requested to make sure no one is within the working radius of the crane before operating.

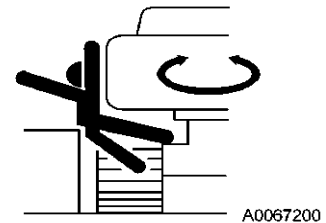

### CAUTIONS UNDER COLD WEATHER

- Remove snow from and defrost the surface of the slewing gear, boom and around winch, and ensure that their movements before starting work.
- Check the brake of winch to ensure that it works properly.
- Operating the Machine without sufficient engine warm-up causes slow response of the Machine to the operation of levers and pedals, and thus unexpected motion may occur against the operator's will. Do not fail to execute the engine warm-up. The engine requires an adequate warm-up time especially in cold climates.
  - ★For details of engine warm-up, refer to "OPERATION 3.4.1 WARM-UP OPERATIONS FOR ENGINE" and "OPERATION 3.4.2 WARM-UP OPERATIONS FOR HYDRAULIC EQUIPMENT".
- Avoid revving up the engine immediately after starting it.
- Deposited snow within the crane operation range may cause tumbling of unloaded objects or catching feet of operators around the Machine. First remove snow before starting a crane operation.
- In cold weather conditions, check that the load before being hoisted is not frozen to the ground or other substance. Attempt to hoist without knowing the load is frozen and stuck to the ground or other substance is dangerous.
- At the end of the work, if substances such as condensation, snow or mud are stuck to the wire harnesses, connectors, switches, sensors or similar parts, wipe them off and put covers on them. If the infiltrated condensation and/or similar substance freeze, the Machine may operate improperly upon the next use and cause unexpected accidents.



**PAY ATTENTION TO WEATHER INFORMATION**

- A risk of lightning exists in case of a thunderstorm, so abort operating the crane, immediately lower the load and retract the boom.
- Wind can cause the hoisted load to move back and forth, which could cause the machine to become unstable. If the hoisted load is affected, immediately lower the load and retract the boom.
- If the maximum instantaneous wind speed is 10 m/s or greater, abort operating the crane, immediately lower the load and retract the boom.
- Even when the maximum instantaneous wind speed is below 10 m/s, the bigger the hoist load, the higher the hoist load position, or the longer the boom can increase the effect from the wind. Be very careful during the work.
- When operating the extended boom, the winch wire rope and electric signal cables are prone to be blown up by winds, and thus be cautious of the operation. Similarly, the peripheral area of a high-rise building, winds blow its sides and may gather their velocity much higher, which deserve attention.
- When a load such as a steel plate that has a large area exposed to wind is being hoisted, the wind arriving from front/rear/side of the boom may cause the Machine to trip or damage the boom. Be very careful during the work.
- The higher the boom is derricked, the higher the probability of tumbling backward is raised by wind blowing from ahead. Thus, adequate attention is required in the operation.
- When an earthquake occurs, abort the operation and wait until it is over.
- ★ The following table indicates approximate relation between the wind speed and wind effect. The wind speed mentioned in the weathercast is mean wind velocity (m/s) during 10 minutes at 10m above the ground.

Force	Wind velocity (m/s)	Effect On Land
0	Less than 0.3	Smoke rises vertically.
1	0.3 - below 1.6	Wind motion visible in smoke.
2	1.6 - below 3.4	Wind felt on exposed skin.
3	3.4 - below 5.5	Leaves and small twigs move in constant motion.
4	5.5 - below 8.0	Dust and loose paper blow up. Small branches begin to move.
5	8.0 - below 10.8	Bushes with leaves start to sway. Waves form on the face of pond/swamp.
6	10.8 - below 13.9	Large branches begin to move. Whistling heard in electrical wires. Use of umbrella becomes difficult.
7	13.9 - below 17.2	Whole trees start to shake. Effort needed to walk against the wind.
8	17.2 - below 20.8	Twigs broke from trees. Progress impeded.
9	20.8 - below 24.5	Light structure damage. Slates blown off.
10	24.5 - below 28.5	Trees uprooted. Considerable structural damage.
11	28.5 - below 32.7	Widespread structural damage.



### CAUTIONS WHEN SLINGING

- Check the following before hoisting a load.  
Attempt to hoist the load without checking may result in serious accidents by dropping the load or tripping.
  - Observe the values in the rated total load chart.
  - Hoist from the centre of gravity of the load.
  - Check that the wire rope of the hook block is vertical.
  - When the load leaves the ground, stop winding up the load once and check whether the load is stable.
- Before hoisting a slung load, always check whether the sling wire rope "retainer device" of the hook block is hung correctly. If the "retainer device" is not hung, the wire rope may leave the hook block and cause the load to fall resulting in a serious accident.
- Larger wire rope angle when hoisting the load increases force that applies to the wire rope even when the load weight is unchanged, thus may cause the wire rope to snip. Give due consideration to slinging operation so that excessive force is not applied to the wire rope.
- Hoist only 1 piece of load at a time.  
Attempts to hoist more than one load may cause the hoist bracket to hit and damage the other hoisted load, or the loads move and lose balance, causing serious accidents such as tripping.  
Do not hoist more than 1 piece of load even if the total combined weight is within the rated total load.
- Hoisting of lengthy load causes the load to lose balance and is dangerous.  
In the case of such load, hoist vertically by using a clamp, or achieve balance of the hoisted load by applying a rope to both ends of the load.

### CAUTIONS WHEN HANDLING WIRE ROPE

- Wire ropes can wear out from constant use or old age, so be sure to inspect every time before work, and replace immediately if at or beyond the replacement standard.  
At the same time, inspect the sheave at the tip of the boom and the sheave of the hook block. Damaged sheaves accelerate the damage of the wire ropes.
- Use wire ropes specified by us.
- Otherwise, the operator may get wounded by snapped wires that are sticking out.  
Always wear leather gloves when handling the wire rope.
- Do not use a wire rope of which any of the following applies:
  - 10 % or more of wires of 1 strand (except a filler wire) of a wire rope are snapped.
  - The wire rope diameter abrasion is beyond 7% of the nominal diameter.
  - Kinked wire rope.
  - Excessively deformed or corroded wire rope.
  - Affected by heat or sparks.

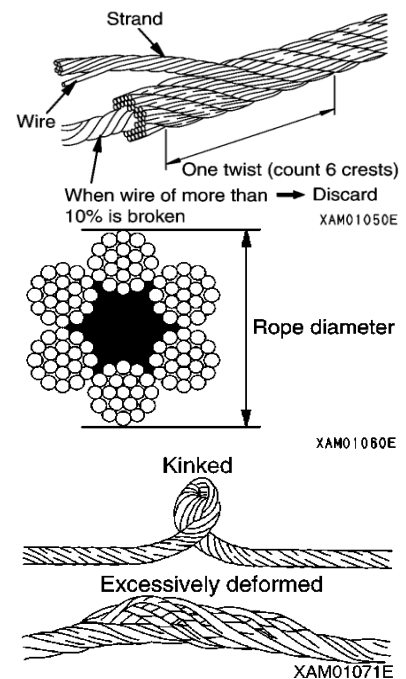



## CAUTIONS WHEN OPERATING CRANE

- Stability of a crane is decisively critical in the transverse direction of the carrier. In the diagonal direction, although stability is increased, exceeding the rated load may result in damage of the boom or Machine body. Do not turn the moment limiter (overload prevention device) off, even if operating in the diagonal direction.
- Be sure to check that the override switch is at the "OFF" (auto) position before operating the crane. Do not attempt to operate the crane when the override switch is at the "ON" (cancel) position. The override switch is permitted to be at the "ON" (cancel) position only during inspection or maintenance works.
- Perform work while paying attention to the display and warning of the monitor of moment limiter (overload prevention device).
- Attempt to work beyond the capacity of the Machine may cause serious accidents and failures caused by for instance tripping or fluctuation. Observe the rated total load chart when operating the crane.
- Perform the crane operation slowly.  
Sudden use of lever or accelerator may cause risks such as shaking, dropping of the load or collision with the surroundings. Be especially careful to be slow during the slewing operations.
- When operating the crane, appoint a work supervisor and perform the work under the supervisor's instructions.  
Follow the supervisor's instructions on the method and procedure for the work. Determine the method for details of mutual signs and follow the signs.
- Hoisting of lengthy load causes the load to lose balance and is dangerous. In the case of such load, apply a rope to both ends of to stabilize the hoisted load.
- Do not allow unauthorized personnel to approach the working radius or under the load because of risks of falling load and contact with load. This could cause a serious bodily accident. Also consider that the working radius increases when the load is hoisted and the boom is deflected.
- Operations requiring more than the machine performance can cause accidents or failure. Crane operations must always be carried out according to the rated total load chart.
- Be careful to prevent the wire rope and/or hoisted load from contacting an obstacle such as a tree or steel when hoisting a load.  
If caught by an obstacle, do not forcibly wind up the hoist load, but untangle the caught part before winding up.
- Do not pull laterally, pull toward you or hoist diagonally. Such attempt may cause the crane to tumble or get damaged.
- It is dangerous to operate the crane under bad weather or at places where the view is not clear.  
Work lamps or other lighting devices should be used in dark places.  
When the view is bad because of bad weather (rain, fog, snow, etc.), stop the operation and wait until the weather recovers.
- Do not use for purpose, for instance raising a person using a crane, other than the true purpose.
- If the alarm buzzer of the over-hoist detector sounds, immediately release your hand off the winch lever. Winding-up of the hook block stops. Then, operate the winch lever "downward" (push it forward) to wind down the hook block. Also, a boom extending operation hoists the hook block. For the distance from the boom and hook block, provide a sufficient allowance for operating the crane.
- When the boom is extended, the hook block is wound up. Operate the winch lever "downward" and extend the boom while lowering the hook block.
- If an overload is caused during work, operate the winch lever "downward" and wind down the winch to unload.  
Do not violently raise or lower the boom. Such attempt may cause serious accidents by tumbling.
- The volume of the hydraulic oil in each of the cylinders changes depending on the temperature.  
By leaving idle with a load being hoisted, as the time passes by the oil temperature drops and the hydraulic oil volume decreases, and changes such as the boom derrick angle decrease and boom length decrease may occur.  
In that case, execute boom derricking operations and boom extension operations appropriately to correct.
- Do not leave the operator's seat when a load is hoisted. When leaving the operating position, first unload and set the lock lever to "LOCK" position.
- When the hook block is not used, wind up the winch.  
The hook block of an empty load may hit operators near the load.
- Operation while hoisting a vibro compactor or other vibration generating attachment is in principle prohibited. The winch or other unit may be damaged by the vibration of the attachment.

### CAUTIONS ABOUT HIGH TEMPERATURE OIL WHEN OPERATING CRANE

When hydraulic oil temperature exceeds 80°C, high pressure hoses and seals can be damaged by heat, and it may cause burning to skin from oil spray.

If temperature of hydraulic oil exceeds 80°C, stop the operation and wait until the oil cools down.

Continuous crane operation for a high lifting height with the accelerator pedal depressed will increase the hydraulic oil temperature. Take special care during this operation.

### CAUTIONS WHEN OPERATING WINCH

- Select a suitable number of wire rope falls to the hook and boom length to the mass of hoisted load.  
★ Refer to "OPERATION 4. HANDLING OF WIRE ROPE" for details.
- Do not allow persons to enter the area below the hoisted load.
- When hoisting a load, always stop once at the "takeoff" position where the hoisted load leaves the ground. Check subjects such as load stability and load force, then hoist up the load.
- Do not pull laterally, pull toward you or hoist diagonally. Such attempt may cause the crane to tumble or get damaged.
- Overwinding of the hook block may result in collision with the boom, snipping the wire ropes and causing the hook block and load to fall and may lead to serious accidents. Take care not to overwind the hook block.
- Be careful to prevent the wire rope and/or hoisted load from contacting an obstacle such as a tree or steel when hoisting a load.  
If caught by an obstacle, do not forcibly wind up the hoist load, but untangle the caught part before winding up.
- Do not use the winch drum wire that is wound up irregularly. If wound up irregularly, not only the wire rope gets damaged and the lifetime is shortened, but it may snip the wire rope and causes serious accidents.  
Observe the following precautions to avoid wire rope from winding up irregularly.
  - Do not let the hook block tumble on the ground.
  - When lowering the hook block for a long distance for underground works, be sure to leave more than 3 turns of the wire rope on the winch drum.
- When decelerating from a high-speed hoisting, slacken the accelerator pedal to lower the engine revolution, and then slowly return the right-hand side machine operation lever. A sharp returning of the right machine operation lever while leaving the revolution at a high level causes the hook to jump up due to the rapid deceleration shock, resulting in an irregular winding.
- Use the winding and unwinding operations in the high-speed mode when winding or unwinding the hook only. Winding and unwinding a hoisted load in the high-speed mode may cause such a serious accident as damage of the boom or frame, or tumbling of the Machine.
- If the wire rope is twisted and causes the hook block to turn, fully eliminate the twist before work.  
★ Refer to the description under "OPERATION 4.3 MEASURE WHEN WINCH WIRE ROPE IS TWISTED".

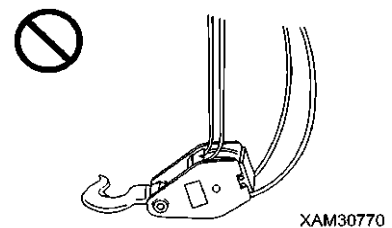
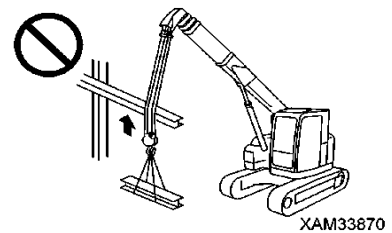
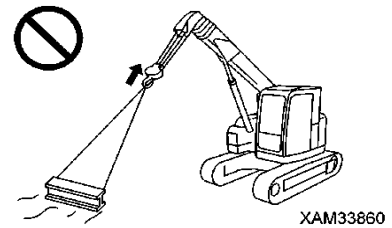



### CAUTIONS WHEN OPERATING BOOM

- Perform boom operation lever operation as slowly as possible. Especially avoid sudden lever operations when the load is hoisted, which may cause the load to wobble and give large impact to the Machine, and thus may damage the crane or trip the Machine.
- When the boom is lowered, the working radius increases, and the rated total load that can be hoisted decreases. When working while raising/lowering the boom, pay extra attention so that the mass of the load at the time the boom is most lowered does not cause overloading.
- Pulling of the load laterally by raising/lowering, and/or extracting/retracting the boom is prohibited. Do not attempt to do the above under any circumstances.
- When telescoping the boom, be cautious while checking the winding of the hook block.
- When the boom is extended, the working radius increases, and the rated total load that can be hoisted decreases. When working while extending/retracting the boom, pay extra attention so that the mass of the load at the time the boom is most lowered does not cause overloading.

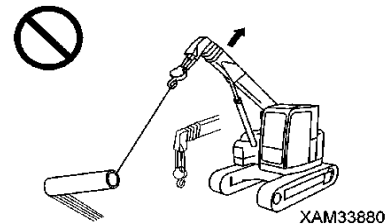

### CAUTIONS DURING SLEWING OPERATION

- Check the safety in the vicinity and honk the horn before slewing.
- Perform the slewing lever operation as slowly as possible. Make sure to start smoothly, slew at low speed, and stop quietly. Especially avoid sudden lever operations when the load is hoisted, which may cause the load to wobble and cause the Machine to lose balance, and thus may damage the crane or trip the Machine.
- Attempts to pull the load towards the machine or let the load stand up by slewing operation are strictly prohibited. Do not attempt to do the above under any circumstances.
- Be careful to prevent the wire rope and/or hoisted load from contacting an obstacle such as a tree or steel when hoisting a load or slewing. If caught by an obstacle, do not forcibly wind up the hoist load, but untangle the caught part before winding up.

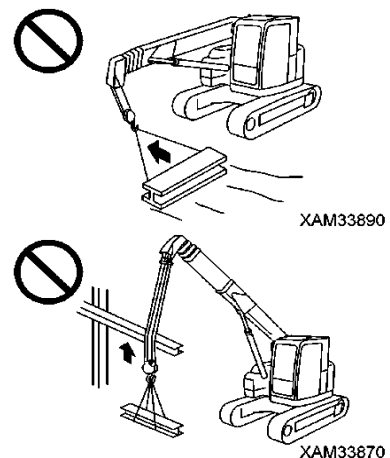

### COOPERATION HOISTING IS PROHIBITED AS A GENERAL RULE

Cooperative hoisting, where two or more cranes are used to hoist a single load, is prohibited as a general rule.

Cooperative hoisting is a highly dangerous operation that may invite tumbling of the Machine due to deviated center of gravity, fall of hoisted load and damage of the boom.

If cooperation hoisting is required for unavoidable reasons, discuss and establish a work scheme under the responsibility of the user, let the worker fully acknowledge the work method and procedures, and only proceed under the direct leadership of the work supervisor.

Also, observe the following cautions:

- Use the cranes of same model.
- Choose the Machine model that can handle sufficiently larger load than the load to be hoisted.
- Make sure only one person gives signals.
- Limit the crane operations to single operations as a rule, and do not attempt any slewing operation.
- Appoint one responsible sling operator who is most experienced.



### CAUTIONS FOR WORK AT WORKPLACE WHERE LIFT BELOW GROUND LEVEL IS PERFORMED

- When lowering a wire rope in work underground, leave at least three loops of wire rope on the winch drum.
- Make sure to give signals.
- Perform crane operation with extra care.

### CAUTIONS ON TAVELING WITH HOISTED LOAD

Hoisted load traveling operation is in principle forbidden, because it is extremely unstable and dangerous.

When inevitably performing a traveling with a hoisted load, observe the following. Negligence of the precautions may cause serious bodily accident.

- Strictly observe the precautions described in the instruction manual.
  - ★Refer to the descriptions under "OPERATION 3.24.1 PRECAUTIONS IN OPERATION DURING TRAVELLING HOIST ".
- Carefully observe the precautions on the operation details for the working posture prescribed in the instruction manual.
  - ★Refer to the descriptions under "OPERATION 3.24.2 OPERATION POSTURE DURING TRAVELLING HOIST ".
- As to the hoisted load, limit its weight within an allowance and assure its clearance above ground.
- For a traveling operation, appoint marshallers.
- Remove any obstacle on the operation path and allow no operator to trespass the path.
- Operating for a distance exceeding the specified boom length is prohibited.
- Since the rated total load refers to the maximum value, suppress the load to a safe level in accordance with operating situation.
- To perform a traveling operation with a hoisted load, keep the engine revolution to an idling low speed so that the load will not swing and set the traveling speed to the low mode (1st speed) to run slowly. Refrain from suddenly starting or stopping, or shifting to a high-speed mode (2nd speed).
- During traveling with a hoisted load, do not shift the vehicle running speed mode or perform crane operation.





### 3. TRANSPORT PRECAUTIONS

#### CAUTIONS DURING TRANSPORT

When transporting the Machine, there is a risk of inviting a serious bodily accident incurred by an accident during transportation.

Strictly observe the following when transporting the Machine.

- Depending on the type of crane installed, the mass, height and total length of the machine are varied, and thus check these details.
- When traveling on a bridge or passing over a structure, check in advance the bridge and viaduct to ensure that they can withstand the mass of the trailer and the machine, and firm up the transportation route.
- When traveling on a public road, notify the competent authority to receive permission for the transportation.
- The Machine may require disassembled transportation in accordance with related regulations (such as the enforcement ordinance of the Road Traffic Act). Contact us or our sales service agency when conducting the transportation.

#### CAUTIONS WHEN LOADING OR UNLOADING

Pay particular attention to the loading or unloading operation of the Machine, which may invite such an accident as tumbling or falling of it.

When conducting a loading or unloading of the Machine, strictly observe the following precautions:

- Select an area with horizontal and solid ground for setting the Machine. In addition, keep enough distance from the roadside.
- Use the ramps under 15° or smaller angle. In addition, decide the clearance between ramps to meet the center of the crawler.
- Use the ramps that have fully strong width, length and thickness, and that enable safe loading/unloading. Reinforce with blocks or other substances if the ramps deflect much.
- Remove the mud and other substances from the footing to prevent the Machine from skidding over the ramps. Remove the substances stuck on the ramps such as grease, oil or ice, and keep clean.  
Be especially careful on the rainy days when slips may easily occur.
- Be sure to set the switch of automatic deceleration to OFF (cancel). Turning the automatic deceleration switch ON rapidly levy up the engine revolution, resulting in a sudden start of acceleration, and thus it is very dangerous.
- When loading or unloading the Machine, be sure to set the Machine to a traveling posture and fix the hook block to the Machine body by using wire ropes.  
★ Refer to the descriptions under "OPERATION 3.7 MACHINE TRAVELLING POSTURE".
- When loading or unloading, set the engine rotation to low idling (low speed rotation) and operate slowly by low speed travels.
- Always move backward when loading the Machine. Moving forward may cause the machine to fall.
- Do not operate any other lever than traveling levers (forward/reverse traveling) on the ramp boards.
- Never change direction on the ramp. Temporarily leave the ramp before correcting the direction.

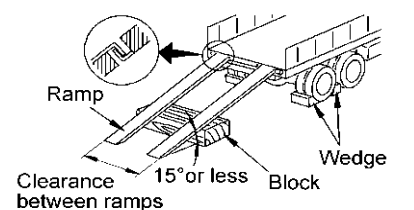

AE50648AE

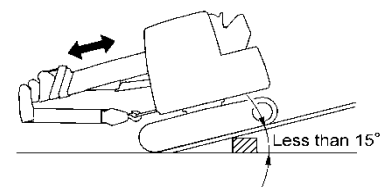

XAM14620E

**CAUTIONS WHEN LOADING OR UNLOADING (CONTINUED)**

- Across the border of ramp and loading deck, the center of gravity of the Machine rapidly moves and thus the Machine becomes unstable. Accordingly, pass the border particularly slowly.
- When unloading the Machine and placing the load onto an earth fill or platform, secure sufficient width, strength and inclination of the ground or the platform.
- Set the Machine to a traveling posture and be slow when operating to change the direction on the trailer platform where the footing is unstable.
- After loading the Machine, be sure to lock the cabin door. Otherwise, the door may flung open during transportation.
- After loading the Machine, apply the wood blocks so that the Machine does not move, and securely fix with wire ropes or other means.
- ★ Refer to the descriptions under "OPERATION 5.1 LOADING/UNLOADING".
- ★ Refer to the descriptions under "OPERATION 5.3 CAUTIONS DURING TRANSPORTATION."

## 4. MAINTENANCE PRECAUTIONS

### 4.1 PRECAUTIONS BEFORE MAINTENANCE

#### PUT UP A WARNING SIGNBOARD DURING INSPECTION/MAINTENANCE

- When warning sign "DANGER. DO NOT OPERATE!" is put up, the Machine is being inspected and under maintenance. Do not start the engine and refrain from touching operating levers. Disregarding the warning sign to operate the Machine may give rise to the danger of involving the preparing personnel into the rotating parts or movable parts of the Machine, resulting in serious injury.
- Put up additional warning signs around the Machine as required.

Part number of warning signboard: 585-4738300

When this warning signboard is not used, store it in a tool box. If no tool box is available, keep it in a holder for the instruction manual.

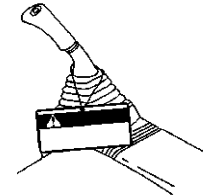

AE305910



#### TIDY UP WORKPLACE

- Always tidy away tools, hammers and other things that obstruct the working area; grease and oil should be wiped off immediately after use to assure safe operations. An untidy workplace may cause safety hazards and result in injuries to personnel.

#### SELECTING A WORKPLACE

- For inspection and maintenance, select an area with flat and solid ground.
- Select such a place where no risk of landslide, rock fall or flooding is feared.

#### KEEP AWAY UNAUTHORIZED PERSONNEL

During maintenance servicing of the Machine, never allow any personnel except the required persons.

Appoint monitoring personnel as required.

#### FOLLOW SUPERVISOR'S INSTRUCTION DURING TEAMWORK

Appoint a person who supervises the work and follow his/her instructions in case of Machine repair or installing/uninstalling a work device.

Unexpected accidents due to misunderstood communication between workers may occur during teamwork.

**KEEP ENGINE STANDING STILL DURING INSPECTION AND MAINTENANCE**

- Before starting inspection and maintenance servicing, be sure to retract the crane and stop the engine.
- Turn the starter switch to ON position and move each of the left and right operating levers back and forth to the full stroke for 2 to 3 times so that the residual pressure in the hydraulic circuit is relieved. Set the lock lever (1) to LOCK position (L) to turn the starter switch OFF.
- Check to ensure that the battery relay is turned OFF and main power current is not turned ON.
  - ★ After turning the starter switch OFF, wait for approximately 1 minute and push the horn switch. If the horn is not honked, no current is ON.
- Turn the disconnect switch in the battery box OFF to shut off the power supply circuit in order to prevent the system from unexpectedly activated during inspection and maintenance servicing.
- Apply pawls to prevent crawler from moving.

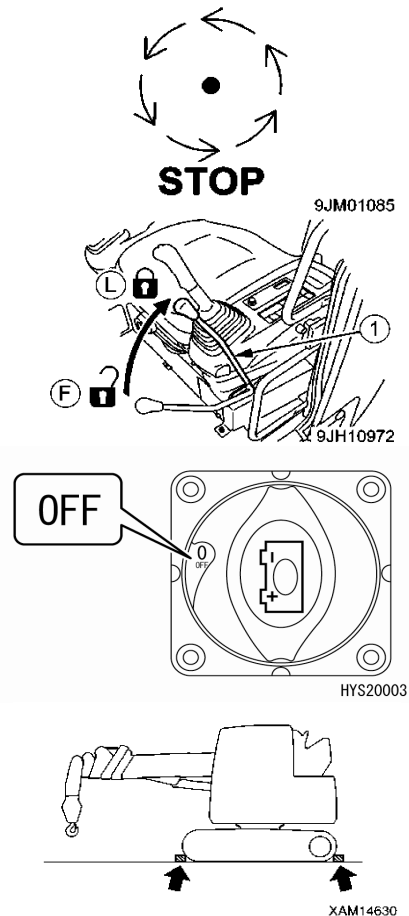

**WORK BY AT LEAST TWO PERSONS DURING MAINTENANCE WITH ENGINE RUNNING**

- To prevent accidents, do not attempt maintenance when the engine is running.  
Always observe the following in case of maintaining with the engine running for unavoidable reason.
- One person should occupy the operating seat to be ready for stopping at any time, and keep communications each other.
  - When working near such rotating parts as fan, belt, and winch drum, keep the operator's body and any object that can be readily caught away from these parts.
  - Never allow any object or tool to fall on or insert into the rotating parts of fan, belt and winch drum. Such an object may hit the rotating part or spring back from it, and thus it is dangerous.
  - Do not touch operation levers. If it is unavoidable to use the operation levers, always give a sign to the other person and let him/her evacuate to a safe place.
  - Set the lock lever (1) to the "LOCK" (L) position.
    - ★ Refer to the descriptions under "MAINTENANCE 12. RELIEVING INTERNAL PRESSURE OF HYDRAULIC CIRCUIT."
  - Do not touch operation levers and pedals. If it is unavoidable to use the operation levers and pedals, always give a sign to the other person and let him/her evacuate to a safe place.

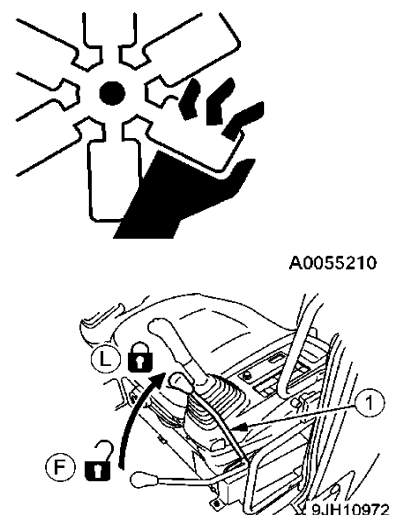



**USE APPROPRIATE TOOLS**

Use proper tools and handle them in correct manners. Using a damaged or deformed tool and using it for any purpose other than its intended application may give rise to a serious bodily accident.



A0055120

**PRECAUTIONS FOR WORKING AT HIGH ELEVATION**

Secure scaffolding by using a workbench with the stairs when working at high elevation.

**CAUTIONS WHEN WORKING ON MACHINE**

- Tidy the footing to avoid falling and always observe the following precautions during maintenance on the Machine.
  - Do not spill oil or grease.
  - Always tidy away tools.
  - Beware of the footing when walking.
  - Remove dirt, oil and grease from the sole of shoes.
- Never jump off. Use a platform and handrail, and secure your body in three locations (both feet and one hand, or both hands and one foot) when climbing up or down the Machine.
- To prevent oneself from the risk of bodily accidents caused by falling or stumbling due to slipping, never step on a hood or cover.
- When working on the engine hood, use a safety belt.

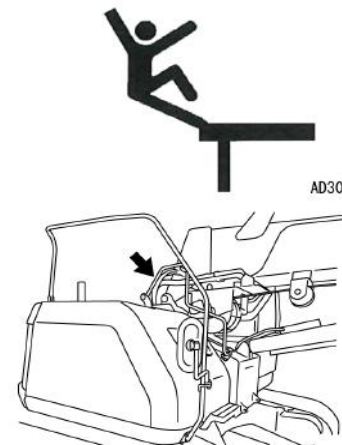

AD305870

HYS20006

**CAUTIONS WHEN WORKING UNDER THE MACHINE AND CRANE**

- For lifting up the Machine, use a hoist or hydraulic jack in good condition and having enough strength to withstand the weight of components. Note that the hydraulic jack should not be used for lifting any part that is damaged, bent or twisted. Further, the wire rope to be used for hoisting shall not include broken wires, be reduced in diameter or kinked. Do not use a hook that is bent or damaged.
- When unavoidably going under the lifted Machine to perform inspection and maintenance servicing, securely support the Machine by using blocks and stays that are sturdy enough to withstand the Machine weight. Failure to support the Machine securely may cause falling of the Machine, resulting in a serious bodily accident.
- Do not use concrete blocks for supporting the Machine. A concrete block may readily be broken even under a light load.



A0055140

### CLEAN BEFORE INSPECTION OR MAINTENANCE

- Before starting an inspection or maintenance, clean the Machine and prevent rubbish from entering the Machine and make sure the safety will be ensured during maintenance.
- Attempt to inspect or maintain the Machine still dirty not only lessens chance of locating faulty part, but may cause rubbish or mud entering your eye, or slipping and tripping that result in injury.
- Always observe the following when washing the vehicle.
  - Use antis lip shoes to prevent slips and trips caused by wet foothold.
  - Put on protective equipment when using a high pressure steam car washer. Avoid an accident from high pressure water which causes skin laceration or mud or other substance to fly to eyes.
  - Do not directly spray water onto the electrical system (sensors and connectors (1)). Water entering the electrical system is dangerous and will cause faulty or improper operations.

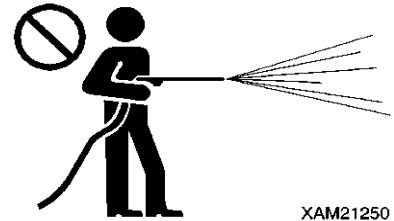

XAM21250

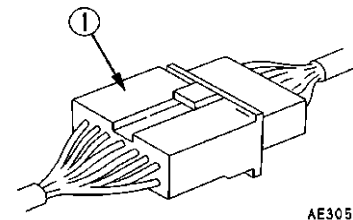

AE305820

## 4.2 PRECAUTIONS DURING MAINTENANCE

### CAUTIONS DURING WELDING REPAIR

Conduct welding operation in a location with good facility, and, only authorized personnel are permitted to be engaged in the welding work. Unauthorized personnel are strictly prohibited since risks such as gas generation, fire and electrical shock are present when welding.

### CAUTIONS WHEN HANDLING BATTERY

Before starting inspection of the battery and handling, set the starter switch to OFF position and the disconnecting switch inside the battery box to OFF position to shut off the power supply circuit in order to prevent the system from unexpectedly activated during inspection and maintenance servicing.

Because the battery produces hydrogen gas, sparks around the battery can cause an explosion.

Moreover, the battery solution contains diluted sulfuric acid. Wrong handling of it may cause a bodily accident, explosion and fire, and therefore always observe the following precautions:

#### • AVOIDING THE RISK OF BATTERY EXPLOSION

- If the battery fluid level decreases to the LOWER LEVEL or further below, do not use the battery or recharge it. Otherwise, an explosion may occur.

Never fail to conduct the regular inspection of battery fluid level and refill purified water (such as battery replenisher available on the market) to the UPPER LEVEL.

- Do not smoke or use fire near the battery.
  - During recharging the battery, it generates hydrogen gas that is flammable.
- Before recharging it, dismount it from the Machine and conduct the recharging in a well ventilated place. During the recharging process, remove the battery cap.

- Securely tighten the battery cap afterwards.

#### • AVOIDING THE RISK OF DILUTED SULFURIC ACID

- Always wear protective glasses and rubber gloves before handling the battery.
- If the battery fluid enters your eyes, wash immediately with water and see a doctor as soon as possible.
- If the battery fluid contacted clothing or skin, immediately wash away by huge quantity of water.

#### • DISCONNECT BATTERY TERMINAL

Before starting the repair work of electric system and performing a welding operation, first turn the starter switch OFF, wait for about one minute, and then disconnect the battery terminals to interrupt the flow of electric current.

#### • DANGER OF SPARKING

To prevent sparking, strictly observe the following precautions:

- Never allow such a metallic object as a tool to come in contact with battery terminals. Do not leave tools or other object around the battery.
- When removing the battery, be sure to disconnect the grounding (-) end terminal first. Conversely for mounting it again, first connect the positive (+) end terminal and fix the grounding end (-) terminal finally.
- Fix the battery terminal securely.
- Fix the battery body to the specified position securely.

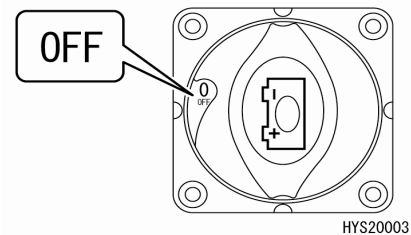

HYS20003

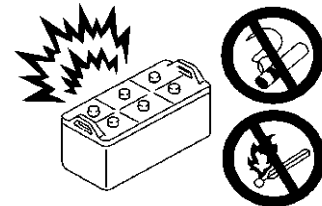

9JM01078

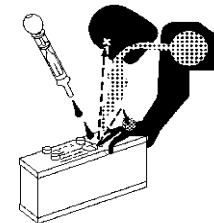

A0055090

Removal

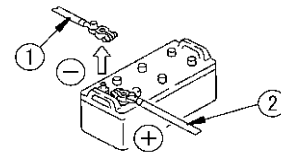

AE40805AE

Installation

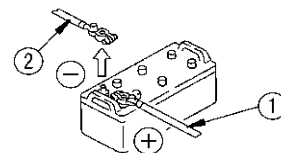

AE40806AE



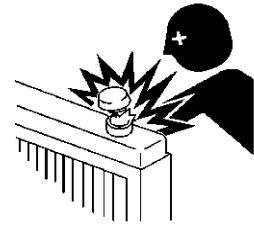

<b>BEWARE OF CHIPS WHEN WORKING WITH HAMMER</b>	
<p>Working with a hammer may cause a serious bodily accident because of springing off of a pin or littering of metallic chips. Strictly observe the following.</p> <ul style="list-style-type: none"> <li>• Hitting a pin or the like may give rise to shattering of broken chips to hurt people nearby. Before starting such a work, make it sure that no one is staying around you.</li> <li>• Knocking a pin off with a strong force may cause the pin flying out to hurt a person nearby. Do not allow anyone to stay around.</li> <li>• When knocking such a hard metallic part as pin or bearing, there is a risk of causing a serious bodily accident by flaying objects. Be sure to wear protective equipment such as goggles, gloves and helmet.</li> </ul>	 <p style="text-align: right; font-size: small;">AE305880</p>

<b>BE CAUTIOUS OF HEATED COOLANT</b>	
<p>When checking or discharging the coolant, ensure that the radiator cap has been cooled down so that it can be touched by bare hand in order to prevent a burn injury because of the spewing hot water or steam. When removing the cap, first loosen it slowly to relieve radiator internal pressure, and then take it off.</p>	 <p style="text-align: right; font-size: small;">A0067380</p>

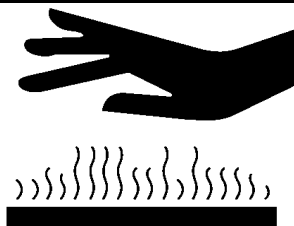
<b>BEWARE OF OIL AT ELEVATED TEMPERATURES</b>	
<p>When checking or discharging oil, ensure that the radiator cap and plug have been cooled down so that they can be touched by bare hand in order to prevent a burn injury because of the spewing hot oil or coming in contact with parts heated at high temperatures. When removing cap and plug, first loosen it slowly to relieve radiator internal pressure, and then take it off.</p>	 <p style="text-align: right; font-size: small;">A0055050</p>

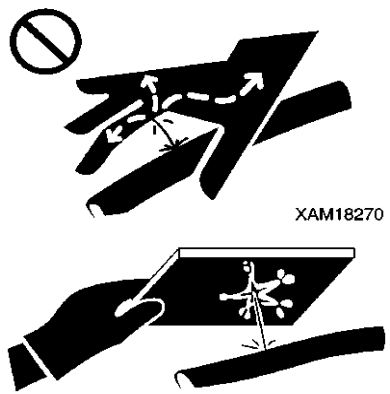
<b>BEWARE OF OIL UNDER HIGH INTERNAL PRESSURE</b>	
<p>The hydraulic system is constantly subjected to an internal pressure. Thus, when checking or replacing the piping and hoses, failure to ensuring that the internal pressure of the circuit has been relieved gives rise to a serious bodily accident. Strictly observe the following.</p> <ul style="list-style-type: none"> <li>• Never replace piping or hoses while the hydraulic circuit is subjected to an internal pressure. Be sure to relieve the pressure of the hydraulic circuit. ★Refer to the descriptions under "MAINTENANCE 12. RELIEVING INTERNAL PRESSURE OF HYDRAULIC CIRCUIT."</li> <li>• If an oil leakage is taking place, the piping, hoses and their periphery are wet. Check to ensure that the piping is free from fissures and the hoses have no cracking or swelling. Be sure to wear protective equipment such as goggles and gloves during the inspection work.</li> <li>• High pressure oil leaking through a small hole may puncture the skin or destroy eyesight upon direct contact. If this happens, wash away with flowing clean water and see the doctor as soon as possible.</li> </ul>	 <p style="text-align: right; font-size: small;">XAM18270</p> <p style="text-align: right; font-size: small;">XAM18280</p>





**BEWARE OF FUEL UNDER HIGH INTERNAL PRESSURE**

In the engine fuel piping, an internal pressure is generated during engine operation. Before starting the inspection and maintenance servicing of fuel piping, wait until its internal pressure is relieved. After stopping the engine, wait for 30 seconds or more before starting the work.

**HANDLING HIGH PRESSURE HOSE AND PIPING**

If fuel leaks from a hose or piping, there occurs a risk of fire and malfunction leading to a serious bodily accident. When leakage of oil or fuel is detected at a loosened joint or mounted spot of hoses or piping, immediately stop the work and re-tighten them with a specified tightening torque. Also, when recognizing a damage or deformation of hoses and piping, consult with us or our sales service agency. If any of the following conditions is found, replace the faulty parts:

- Damage of a hose or deformation of sleeve
- Scratch or truncation of the covering layer, or exposure of wire reinforcement layer
- Covering layer is partially swollen
- Indication of twist or collapse on a movable part of hose
- Foreign object buried in coating



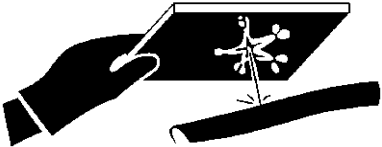

A0055020



XAM18280

**BEWARE OF HIGH VOLTAGE**

During or at immediately after stopping an engine operation, the inside of engine controller and around the engine fuel injector are under a high voltage, and thus an electric shock may occur. Never touch the inside of engine controller and engine fuel injectors. If there is a need for touching these parts, consult with us or our sales service agency.

XAU00050

**BEWARE OF NOISE**

Use ear protection or ear plugs during long-term noise exposure, such as engine maintenance servicing. Large noise in the surroundings may cause hearing difficulty or deafness.

**WHEN ADJUSTING CRAWLER TENSION, BEWARE OF HIGH PRESSURE GREASE**

- The grease inside the crawler adjusting unit is under high pressure. Conducting the adjustment in an unauthorized procedure may cause the grease discharging plug (1) to jump out, resulting in a serious bodily accident.
- When loosening the grease discharging plug (1) to loosen the tension of crawler, do not rotate it more than 1 turn. Also, loosen the grease discharging plug (1) slowly.
- Do not allow your face, limbs and body to come closer to the grease discharging plug (1).

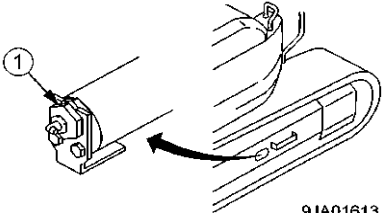

9JA01613



9JM01088



### NEVER DISASSEMBLE THE RECOIL SPRING

Under no circumstances, refrain from disassembling the recoil spring assembly. In the recoil spring assembly that is intended for buffering the idler, a strong spring is installed. An inadvertent disassembling it causes the spring to jump out, inviting a serious bodily accident. Contact us or our sales service agency if its disassembling is required.

### CAUTIONS WHEN HANDLING ACCUMULATOR / GAS SPRING

- This machine is equipped with an accumulator. After stopping the engine, be sure to set the lock lever to LOCK position (L).
- Since the accumulator and gas spring is encapsulated with high pressure nitrogen gas, an erroneous handling of them may cause an explosion and subsequent serious bodily accident. Strictly observe the following.
  - Never disassemble them.
  - Do not allow fire to come closer to them or throw them into fire.
  - Do not attempt boring, boring or gas cutting.
  - Do not knock them, tumbling them or give impact to them.
  - When disposing of them, removal of filled gas is required. Contact us or our sales service agent.

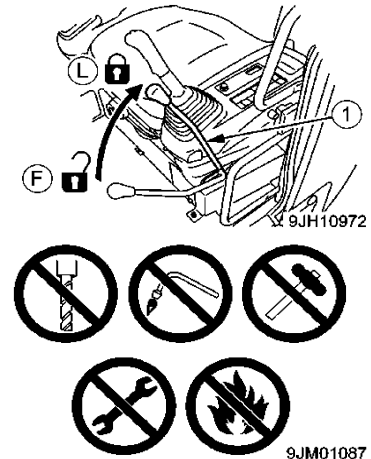

### BE CAUTIOUS OF COMPRESSED AIR

When using the compressed air for cleaning, there is a risk of serious bodily accident because of scattering waste objects. Be sure to wear goggles, dust mask and gloves.

### MAINTENANCE AND INSPECTION OF AIR-CONDITIONER

- If the refrigerant of air-conditioner get into the eyes, loss of sight may occur and if it comes into contact with skin, it gives rise to a frostbite. Never loosen parts of the cooling circuit.
- When conducting the maintenance servicing of the air-conditioner, follow the Fluorocarbon Refrigerants Emission Regulating Act.
- Users (possessors) of the Machine are obligated to conduct periodic inspections as stipulated by the Fluorocarbon Refrigerants Emission Regulating Act. Inspect once in three months. Even when the air-conditioner is not used during off season, the inspection is required.

#### Check item

- Abnormal vibration and abnormal operation noise of the compressor
- Oil oozing out on and around the compressor
- Scratches, corrosion, rust and other blemishes on the compressor
- Frosting of air-conditioner heat-exchanger in the cabin.

### CAUTIONS WHEN TREATING WASTE

In respect of the environment protection, pay sufficient attention to the treatment of waste matters.

- Be sure to use drums and tanks to hold the discharged waste liquid. Never allow waste liquid to flow on the ground, into river, drainage, sea or lake.
- Observe the applicable legal regulations and rules when disposing of this Machine as well as harmful substances such as oil, fuel, solvent, filter or battery.
- When disposing of an air-conditioner, the recovering work must be consigned to a Class 1 fluorocarbon refrigerants filling and recovering contractor registered by the competent authorities.

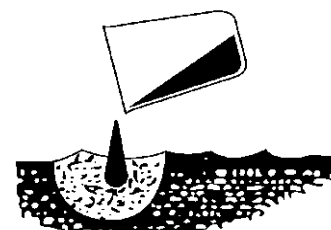

A0055220



### SELECTING WINDOW WASHER SOLUTIONS

Use the window washer based on ethyl alcohol.

Do not use a washer solution based on methyl alcohol because it may hurt the eyes.

### PERIODIC REPLACEMENT OF CRITICAL PARTS

- To assure the prolonged and safe use of the Machine, be sure to conduct the periodic replacement of parts that are particularly related to safety such parts as hoses and seat belts. Materials of these parts tend to change their properties with elapse of service time and will degrade, abrade and show fatigue with repeated services, and thus may cause a serious bodily accident. Also, it should be noted that their service life can hardly determined by inspecting their appearance.
  - ★ Refer to the descriptions under "MAINTENANCE 4. PERIODIC REPLACEMENT OF CRITICAL PARTS".
- If any abnormality is observed in a critical part by appearance, replace it even if it has not reached the time for regular replacement.



## 5. SAFETY LABEL LOCATIONS

Keep safety labels clean and visible at all times.

If lost, replace immediately or apply for a new one.

There are other labels than safety labels shown below and treat them in the same manner.

### [SAFETY LABEL LOCATIONS IN THE CABIN]

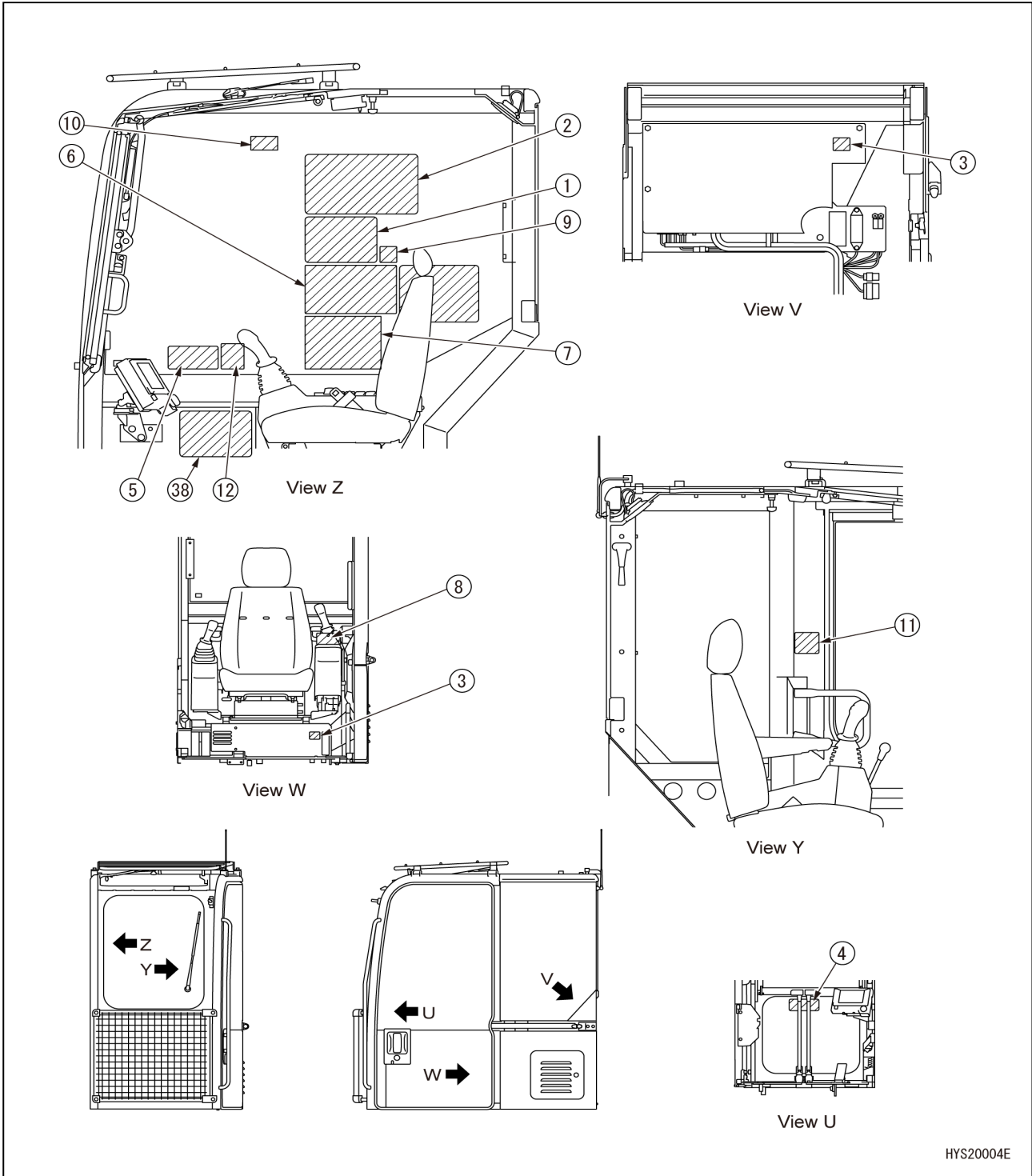



[SAFETY LABEL LOCATIONS OUTSIDE OF THE CABIN]

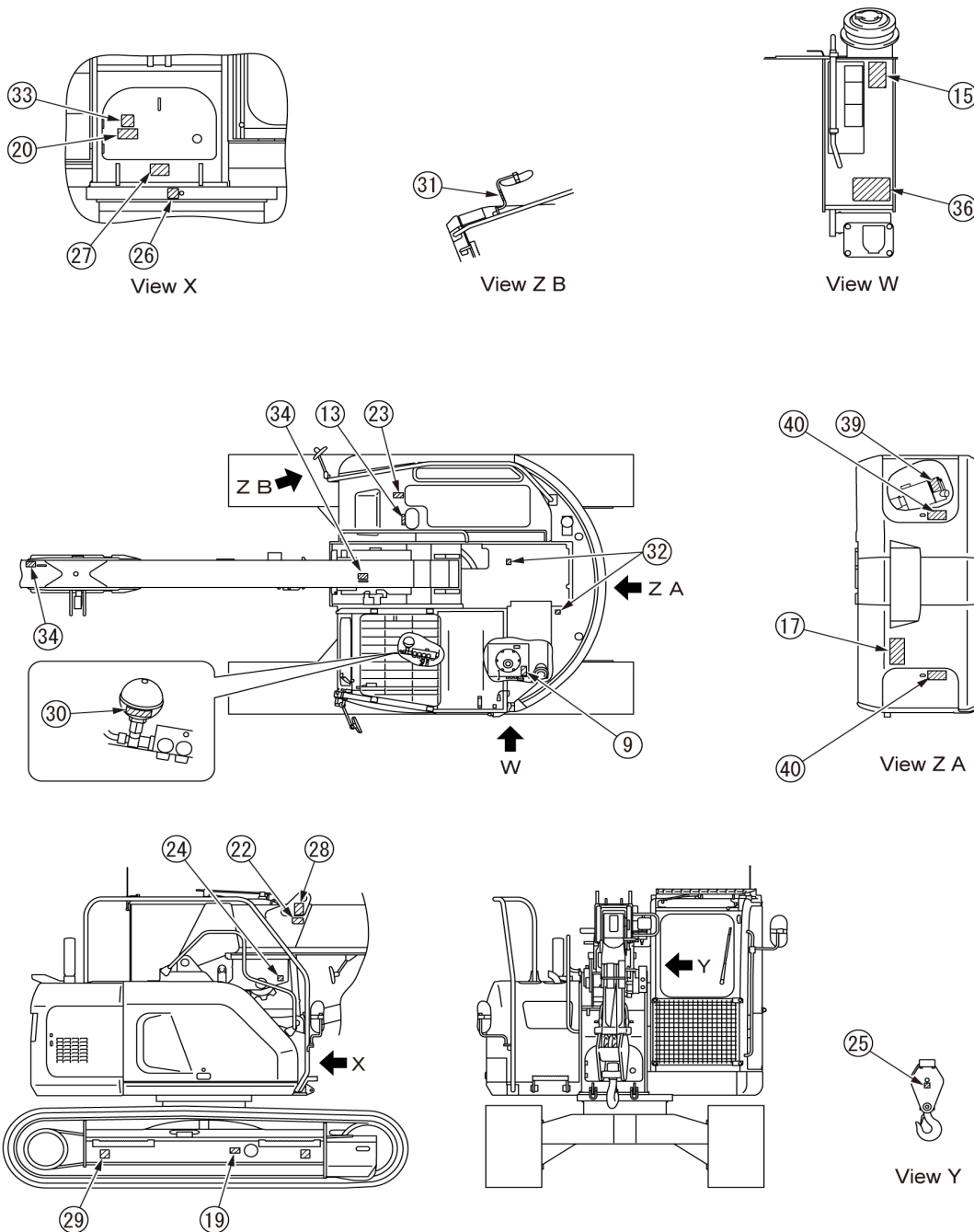

HYS20005E

[SAFETY LABEL LOCATIONS IN THE ENGINE ROOM]

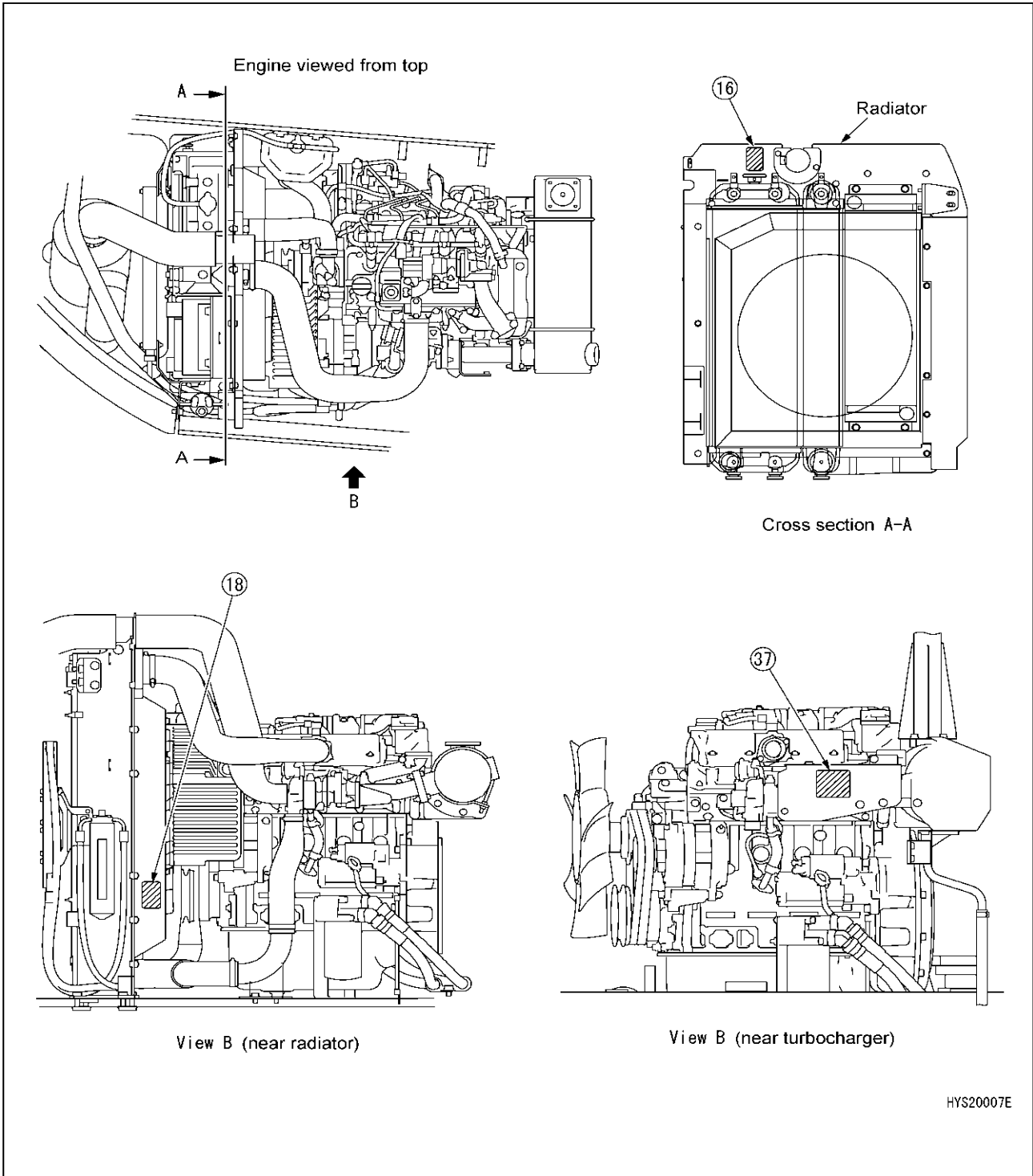



(1) Safe operation (557-3494500)



**FOR YOUR SAFE OPERATION**

Be sure to operate your crane after reading Instruction Manual.

1. Be sure to observe local laws and ordinances for crane operation.
2. Before and after work, be sure to conduct daily inspection, lubrication and other required services.
3. Crane should be operated on level, hard ground.
4. Do not lift any load in excess of rated total load.
5. Make sure that there is no person or obstacle around the machine during work.
6. Do not allow any person enter underneath the lifted load.
7. Whenever leaving your operator seat, be sure to ground the load and shut down the engine.
8. Never pull or drag any load horizontally.
9. Never operate your crane with safety system function disabled.

**CAUTION (Operation)**

1. Definitely avoid composite operation of 3 or more actions. It is too dangerous.
2. Carry out swing operation smoothly, avoiding load to sway.
3. Hoisting loads that produce vibrations is in principle prohibited. Attachments that produce vibrations can cause damage to the winch or other components of the machinery.
4. Do not carry out crane operation on slope.

**CAUTION (Travelling on slope)**

1. When travelling on slope, travel backward on up-hill and forward on down-hill.
2. When travelling in reverse or in lateral position inevitably, be sure inclination is not in excess of 10 degrees.
3. Never perform swiveling travel on slope as it may cause crane to tip over.

**CAUTION (Pick & carry operation)**

1. Pick & carry operation is in principle prohibited as it is extremely unstable and hazardous. If inevitable, perform your work in accordance with rated total load for pick & carry operation.
2. Pick & carry operation is dangerous because load is likely to sway. Travel speed should be set at LD with engine running at low speed.
3. Avoid jerky start, stop and spin turn.
4. While in pick & carry operation, do not perform any crane function other than travel.
5. Never perform pick & carry operation on slope, it may cause the crane to tip over.

**CAUTION (Hook stowage prior to travelling)**

- 1 Always level the boom and slow the hook prior to travel. When stowing the hook, never use the emergency switch. Never attempt to travel with the hook stowed and the boom raised.

**CAUTION (Loading to and unloading from truck)**

1. Travel backward for loading and forward for unloading.
2. Be sure to engage parking brake of truck and apply wheel blocks.
3. Ramp board angle should be less than 15 degrees. Engage the board securely to truck bed and eliminate any difference of height between each board.
4. Never perform any crane operation other than travelling on truck bed or ramp board as it may cause the crane to tip over.

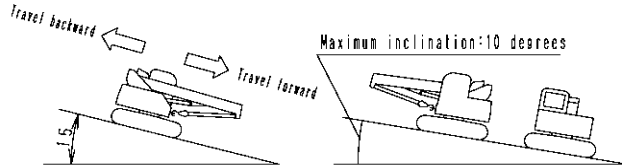

557-3494500

(2) Working range diagram (585-2236900)

**Working Range**

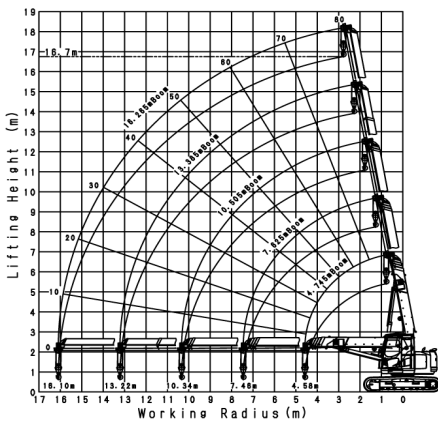

**CC1485S-1 Total Rated Load Chart**

Boom Length (m)	① 4.745mboom		② 7.625mboom		③ 10.505mboom		④ 13.385mboom		⑤ 16.265mboom	
	Stationary	Pick&Carry	Stationary	Pick&Carry	Stationary	Pick&Carry	Stationary	Pick&Carry	Stationary	Pick&Carry
2.00	8000	2000	8000	2000	3000	1500				
2.50	8000	2000	8000	2000	3000	1500	3000			
2.80	8000	2000	8000	2000	3000	1500	3000			
3.00	5250	2000	5260	2000	3000	1500	3000			2600
3.20	4910	2000	4920	2000	3000	1500	3000			2600
3.50	4450	2000	4460	2000	3000	1500	3000			2600
3.85	4000	2000	4000	2000	3000	1500	3000			2600
4.00	3830	1915	3820	1910	3000	1500	3000			2600
4.50	3320	1660	3310	1655	3000	1500	3000			2600
4.58	3250	1625	3240	1620	3000	1500	2840			2600
4.80			3220	1610	3000	1500	2820			2600
5.00			2860	1440	2710	1365	2640			2600
5.50			2520	1260	2400	1200	2340			2320
6.00			2210	1105	2140	1070	2100			2080
6.50			1950	975	1920	960	1890			1880
7.00			1720	860	1720	860	1710			1710
7.45					1570	785	1570			1580
7.50					1530	755	1530			1560
8.00					1400	700	1430			1430
8.50					1270	635	1310			1320
9.00					1150	575	1200			1210
10.00					940	470	1020			1040
10.34					880	440	970			980
11.00							860			890
12.00							750			770
13.00							650			670
13.22							630			650
14.00							580			600
15.00							500			500
16.00							440			440
16.10							430			430
Boom Angle (°)	0~64.3		0~74.4		0~78.7		0~79.0		-	



**GENERAL RULE TO OBSERVE**

- 1 The working radius shown is based on the actual value including boom deflection. Always work in accordance with these values.
- 2 The Working Radius/Lifting Height Diagram is based on operations without a load and does not allow for boom deflection.
- 3 The rated load is the value not greater than 70% of the tipping load when the machine is placed on level, hard ground and forward stability is 1.15 or above.
- 4 Because it can be extremely unstable and dangerous, travelling with a load should be avoided wherever possible. Where it is unavoidable, always operate in accordance with Total Rated Capacity for Travel Suspension.
- 5 The Total Rated Capacity for travelling with a suspended load is calculated for travel on level hard ground only. Always lift the load statically and while travelling with a load, do not allow it to swing. Carry the load as close as possible to the ground and avoid jerky starting, stopping and turning.
- 6 Travelling with a load suspended using boom configurations (4) and (5) is prohibited in all circumstances.
- 7 When the boom length in use exceeds the boom lengths shown in the lifting charts, always operate in accordance with the capacities shown for the next higher boom length.
- 8 Values shown in the Total Rated Load Chart include the hook and any other lifting equipment. To determine the actual safe load deduct the weight of the hook block (90kg) and all other lifting equipment.
- 9 The load is limited by the number of falls of rope between the boom and the hook:-  
1 fall - 1500kg maximum  
2 falls - 3000kg maximum  
4 falls - 6000kg maximum

585-2236900

(3) Washing caution (300-4213900)

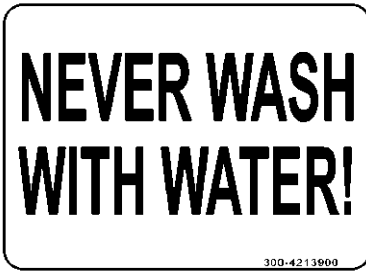

(4) Lever operating patterns (585-3555400)

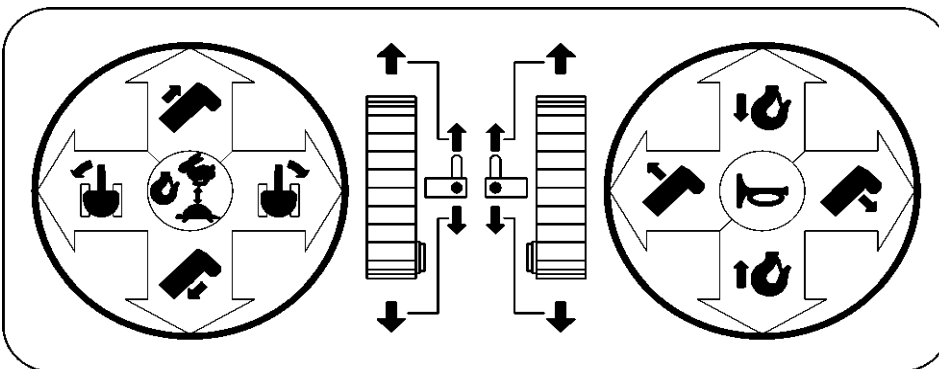

(5) Warning on switching numbers of falls (585-3555500)

	<p style="text-align: center;"><b>!</b> WARNING</p> <p>Before performing lifting operation, be sure to check the number of part reeving and set the selector switch(1,2or4) If the number of part reeving and its selector switch does not coincide moment limiter will not work properly. It may result in serious accident including load dropping ,boom damaging or machine tipping over.</p> <p style="text-align: right;"><small>585-3555500</small></p>
--	---





(6) Operating the moment limiter (585-2237000)

### MOMENT LIMITER OPERATION

- 1 Load capacity display  
Current load factor is displayed.
- 2 Actual load display  
Current lifting load is displayed.
- 3 Rated load display  
Current maximum lifting capacity calculated by number of falls, boom position, and working radius is displayed.
- 4 Boom angle display  
Current boom angle is displayed.
- 5 Working radius display  
Current working radius is displayed.
- 6 Rated radius display  
Current maximum working radius calculated by number of falls, boom position and actual load is displayed.
- 7 Boom length display  
Current boom length is displayed.
- 8 Lifting height display  
Current lifting height is displayed.
- 9 Fall mode select button  
Current number of falls is displayed.
- 10 Pick & Carry / Stationary mode select button  
Pick & Carry mode and Stationary mode can be selected.
- 11 Boom angle upper and lower limit setting button  
Boom angle upper limit and lower limit can be set / canceled.
- 12 Working radius upper limit setting button  
Working radius upper limit can be set / canceled.
- 13 Lifting height upper limit button  
Lifting height upper limit can be set / canceled.
- 14 Slow limit right / left button (working settings)  
Slow limit can be set / canceled.
- 15 Travel speed select button  
Travel speed 1 or 2 (Low or High) can be selected.
- 16 Set or check / set or cancel button  
Set values can be checked / cancelled.
- 17 Overwind detect display  
Overwind detect is displayed. (Normal: Green / Overwind: Red)
- 18 Over un-winding detect display  
Over un-winding detect is displayed. (Normal: Green / Over un-wind: Red)
- 19 Boom angle upper limit LED  
Lights on when boom angle upper limit is set, and blinks in orange when upper limit is reached.
- 20 Boom angle lower limit LED  
Lights on when boom angle lower limit is set, and blinks in orange when lower limit is reached.
- 21 Working radius upper limit LED  
Lights on when working radius upper limit is set, and blinks in orange when upper limit is reached.
- 22 Lifting height upper limit LED  
Lights on when lifting height upper limit is set, and blinks in orange when upper limit is reached.
- 23 Slow limit right upper limit LED (working settings)  
Lights on when right slow limit is set, and blinks in orange when upper limit is reached.
- 24 Slow limit left upper limit LED (working settings)  
Lights on when left slow limit is set, and blinks in orange when upper limit is reached.
- 25 Travel mode select LED  
Red yellow is displayed when travel mode is selected. Arrow goes off when stationary mode is selected.
- 26 Winch speed low / high display  
Current winch speed is displayed. (1: Low / 2: High)
- 27 Travel speed low / high display  
Current travel speed is displayed. (1: Low / 2: High)
- 28 Rear view camera select button  
Press to see rear view camera image.
- 29 Use mode button  
Use for various settings.
- 30 Hook slow button  
Use for hook slow down.
- 31 Fly job length display  
Current fly job length is displayed.
- 32 Fly job angle display  
Current fly job angle is displayed.

**Configuration and how to use its function**

Moment limiter is a safety system installed for prevention accident such as damage or falling over of crane due to over-loading. For safer operation of your crane, be sure to fully utilize this system.

- 1) This system shows lifting load and ratio of rated total load, and also it shows pre-warning (intermittent sound) at 80% of rated total load, and warning (continuous sound) at 100% causing actions of boom lowering, boom extension and hook hoisting to automatically stop, while actions on side side such as boom hoisting, boom retracting and hook lowering remain to function.
- 2) Lifting load is detected by pressure sensor. Rated total load is read out by boom angle and length signal. Then lifting load and rated total load are compared and generates pre-warning, warning, and auto-stop.

**CAUTION**

- 1 Slowing mechanism does not stop automatically when over-loaded. Be careful.
- 2 Before starting to operate your crane, be sure to conduct a start up check.
- 3 Set the moment limiter so that each LEDs show proper working conditions.
- 4 Pay attention to display of moment limiter to avoid over-loading the crane at any time.
- 5 If any action on the side side (boom extend, boom lower or hook hoisting) automatically causes to stop, reset the operation at side side (boom retract, boom raise or hook lowering).
- 6 For lifting a load all the ground, first hold the hook until the load leaves ground and stop it momentarily to check for safety. Never lift rear end off ground by rotation hook.
- 7 While in pick & carry mode, if boom is extended to 4 or 5 stages, functions of travel and crane hook will stop, but this does not mean to be abnormal. In pick & carry mode, use of 4 or 5 stage boom is prohibited. Be sure to work with 3 or lower stages.

585-2237000

(7) Warnings on operation, inspection and maintenance (584-3469700)

		<p style="text-align: center;"><b>CAUTION</b></p> <p>When opening, closing, removing or replacing the windows, in order to avoid accidents caused by inadvertent movement of the controls, before leaving the operator's seat ALWAYS-</p> <ul style="list-style-type: none"> <li>-ground any load</li> <li>-move the safety lock (to the left of the operator's seat) to the LOCK position.</li> </ul> <p>If the machine suddenly starts moving or acts in any unexpected way, serious injury or death may result.</p>
		<p style="text-align: center;"><b>CAUTION</b></p> <p>Whenever you operate the machine, check the operation pattern shown with your intended action. When beginning any operation, start slowly, paying careful attention to all your surroundings.</p>
		<p style="text-align: center;"><b>WARNING</b></p> <p>To prevent SERIOUS INJURY or DEATH before moving the machine ALWAYS</p> <ul style="list-style-type: none"> <li>-sound the horn to alert anybody nearby</li> <li>-ensure nobody is on or near the machine, or in the swing area</li> <li>-safety permitting, position cab to maximize view of travel path</li> <li>-if your view is obstructed, obtain assistance.</li> </ul>
		<p style="text-align: center;"><b>WARNING</b></p> <p>To prepare for fires, decide the fire extinguisher storage location and install one, fully read the attached label for the usage and be prepared for fighting against the emergencies.</p> <p style="text-align: right; font-size: x-small;">584-3469700</p>

(8) Operation prohibiting tag (585-4738300)

## DANGER

### Do NOT operate

When this tag is not being used keep it in the storage compartment. Still more, when there is no storage compartment, keep it in the operation manual case.

585-4738300

(9) Cautions in repairing window breakage (585-4739300)

## WARNING

In the event of window damage, repair or replace the window before continuing operation.

585-4739300



- (10) Cautions in retracting the front window glass (CL000160010)

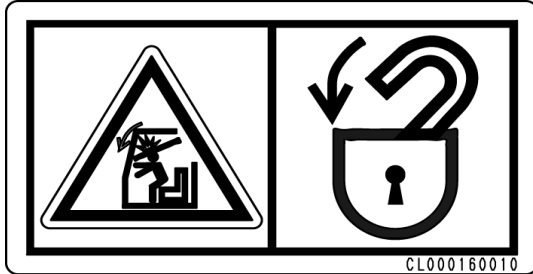

- (11) Cautions in opening/closing the front window (585-4738400)

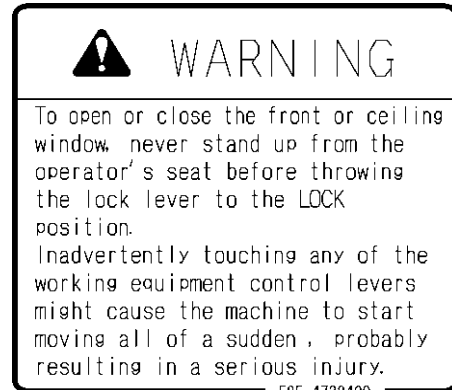

- (12) Cautions in slewing (584-4588100)

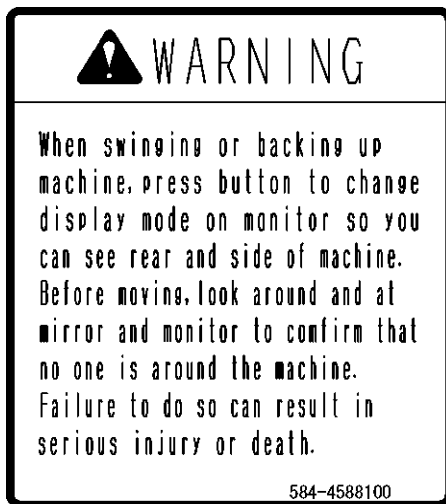

- (15) Diesel fuel (585-4738600)

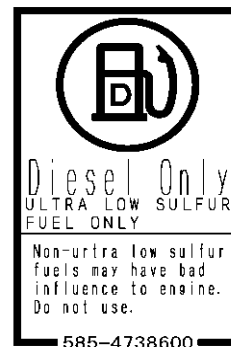

- (13) Cautions for high temperatures of muffler (349-4427800)





- (16) Cautions against the risk of burns  
(CL000170000) (2 spots)



- (18) Caution against rotating parts in the engine room  
(CL000080000)

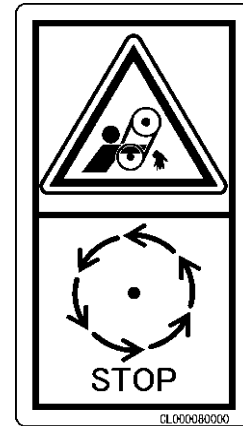

- (17) No entry within the slewing area  
(CL000180013)

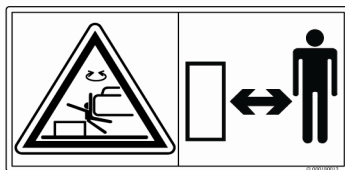

- (19) Cautions for plug popping out  
(CL000190010)

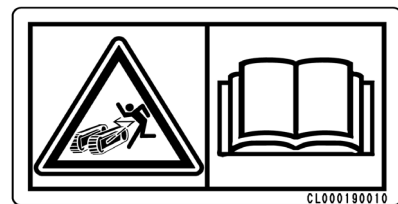

- (20) Caution against suffering from electric shock by battery cable  
(CL000200000)

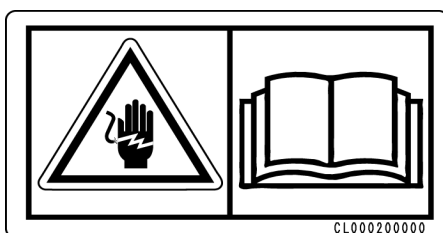

- (22) Warning on body hoisting positions (584-3437800) (2 spots)

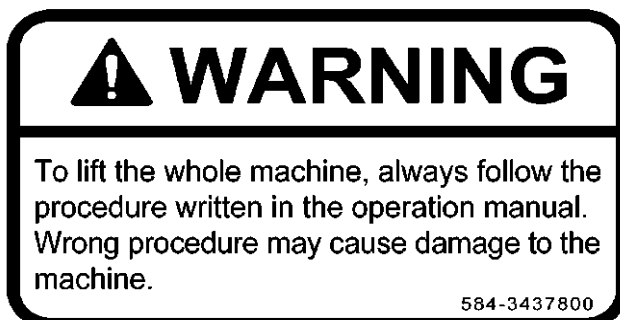



(23) Cautions on the fenders  
(CL000210000)



(24) Warning for winch (553-4267500)



553-4267500

(25) Caution against being entangled  
by the hook block (553-4267400)



553-4267400

(26) Warning (553-4268000)



553-4268000

(27) Body mass indication  
(585-4738900)

CC1485S-1	
MACHINE WEIGHT	
Spec	Weight
Main Unit	14400kg
Fly Jib	+300kg
Rubber Pads	+470kg

585-4738900

(28) Hoisting position  
(585-4714800) (2 spots)

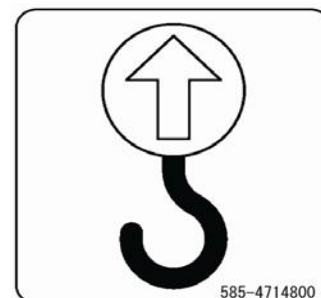

585-4714800



(29) Tethering position indication  
(585-4714200) (4 spots)

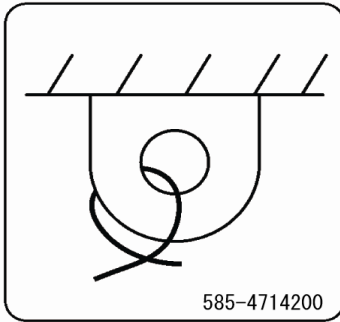

(30) Warnings for the accumulator  
(CL000220030)

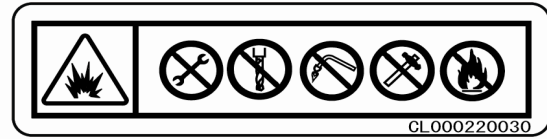

(31) Caution against rotation  
(557-4632500)

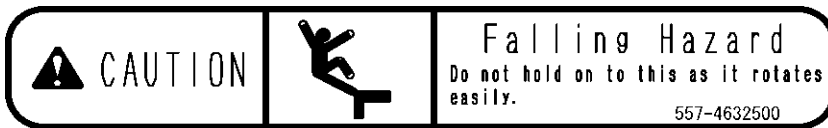

(32) Do not step on  
(584-4581700) (2 spots)



(33) Cautions on disconnect switch  
(585-4714100)



(34) Warning on boom hoisting  
Accessories (103-4576900)

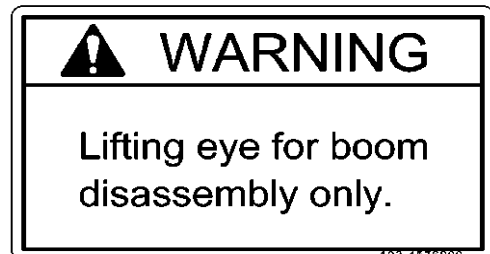

(36) Cautions on override switch  
(585-4739200)

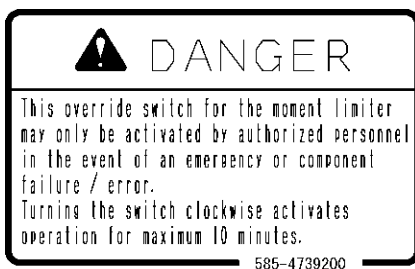

(37) Cautions against the risk of burns  
in the engine room (585-4727600)

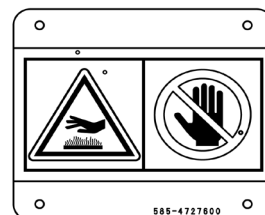

(38) Hoisting machine / Fixing machine (585-3558800)

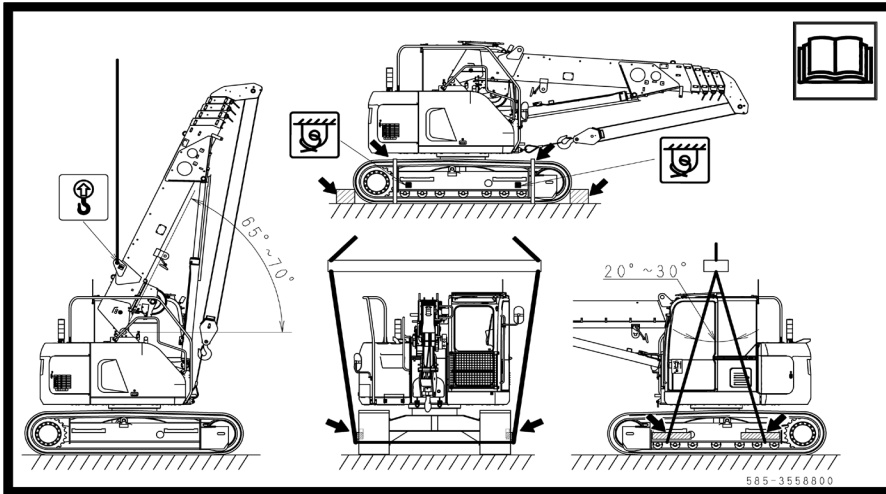

(39) Caution air cleaner (585-4738700)

**Important Notice**

- Do not insert oil in this cleaner.
- Always use genuine elements, and when service indicator turns to red, clean the element.
- If service indicator turns to red after element is cleaned, or exhaust gas color is bad and lacks output, change the element.
- Do not damage or put oil on element. If there is damage, replace. (Refer to the operation manual for instruction of cleaning and replacing of element)

585-4738700

(40) Caution pressure wash  
(CL000240110) (2 spots)





# OPERATION

1. NAME OF EACH SECTION	60
2. EXPLANATION OF ALL EQUIPMENT	63
3. OPERATION	130
4. HANDLING OF WIRE ROPE	192
5. TRANSPORTATION	197
6. HANDLING WHEN COLD	206
7. LONG-TERM STORAGE	208
8. TROUBLESHOOTING	210



## 1. NAME OF EACH SECTION

### 1.1 MACHINE UNITS

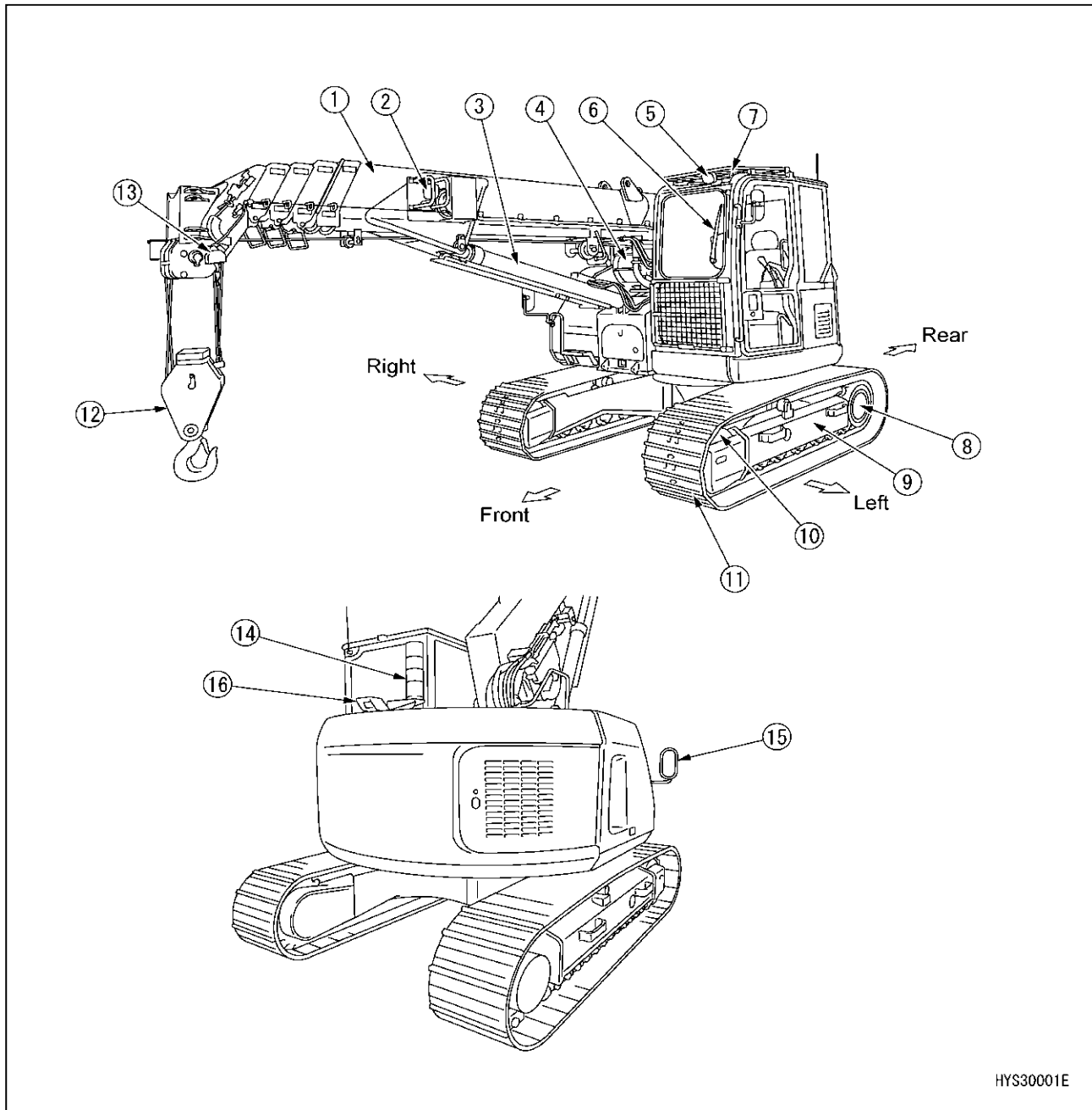

HYS30001E

- |                            |                            |
|----------------------------|----------------------------|
| (1) Boom                   | (9) Track Frame            |
| (2) Working lamp           | (10) Idler                 |
| (3) Boom Derrick Cylinder  | (11) Crawler               |
| (4) Winch                  | (12) Hook block            |
| (5) Head lamp              | (13) Overwinding detector  |
| (6) Wiper (Front window)   | (14) Rotating warning lamp |
| (7) Wiper (Roof Window)    | (15) Rear view mirror      |
| (8) Sprocket, travel motor | (16) Rear view camera      |

## 1.2 CRANE OPERATION UNITS

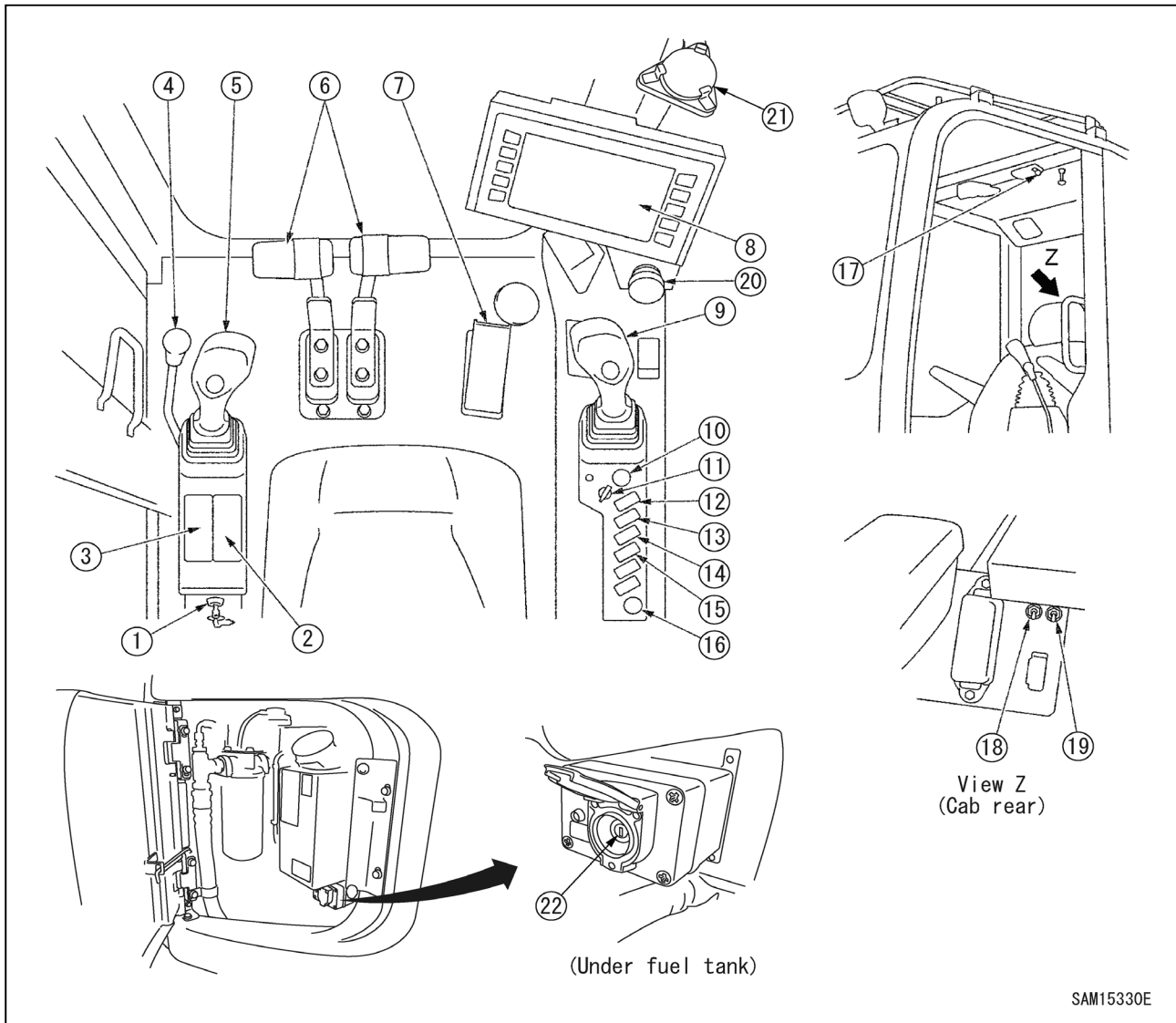

- |  |  |
|--|--|
| (1) Maintenance switch   | (12) Lamp switch   |
| (2) Air conditioner operation unit   | (13) Front window wiper switch                                     |
| (3) Car radio  | (14) Roof window wiper switch                                      |
| (4) Lock lever   | (15) Buzzer canceling switch                                       |
| (5) Left work operation lever (Winch 2-speed selector switch on knob part) | (16) Accessory power supply  |
| (6) Travel lever   | (17) Room lamp switch  |
| (7) Accelerator pedal  | (18) Emergency accelerator driving switch (With guard)             |
| (8) Machine monitor  | (19) Slewing parking brake emergency canceling switch (With guard) |
| (9) Right work operation lever (Horn switch on knob part)                  | (20) Emergency stop switch   |
| (10) Starter switch  | (21) Levelling instrument  |
| (11) Fuel adjustment dial  | (22) Override switch   |

### 1.2.1 MACHINE MONITOR COMPONENTS

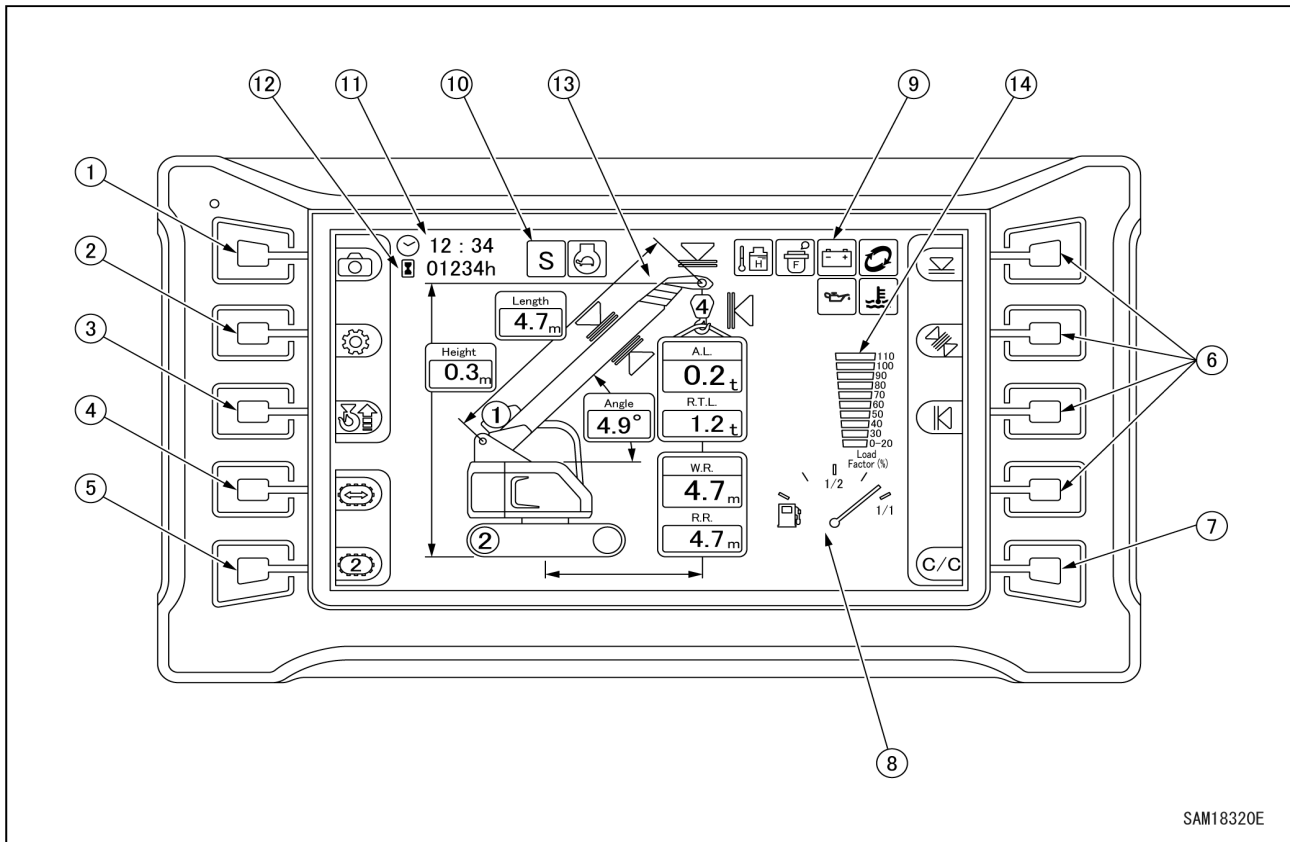

SAM18320E

- |   |   |
|---|---|
| (1) Rear view camera selector switch                            | (8) Fuel gauge                          |
| (2) User mode switch  | (9) Warning display                     |
| (3) Hook storage switch   | (10) Working mode display               |
| (4) Travel mode selector switch                                 | (11) Clock display                      |
| (5) Travel 1st speed/2nd speed selector switch                  | (12) Hour meter display                 |
| (6) Working range regulation setting and canceling switch       | (13) Moment limiter status display      |
| (7) Working range regulation setting check/all canceling switch | (14) Moment limiter load factor display |

## 2. EXPLANATION OF ALL EQUIPMENT

The following is an explanation of equipment necessary for machine operation and work operation. It is most important that you to correctly understand the operation method of this equipment and the display content in order to perform correct, safe and comfortable work.

### 2. 1 MACHINE MONITOR

#### [1] STARTING SCREEN

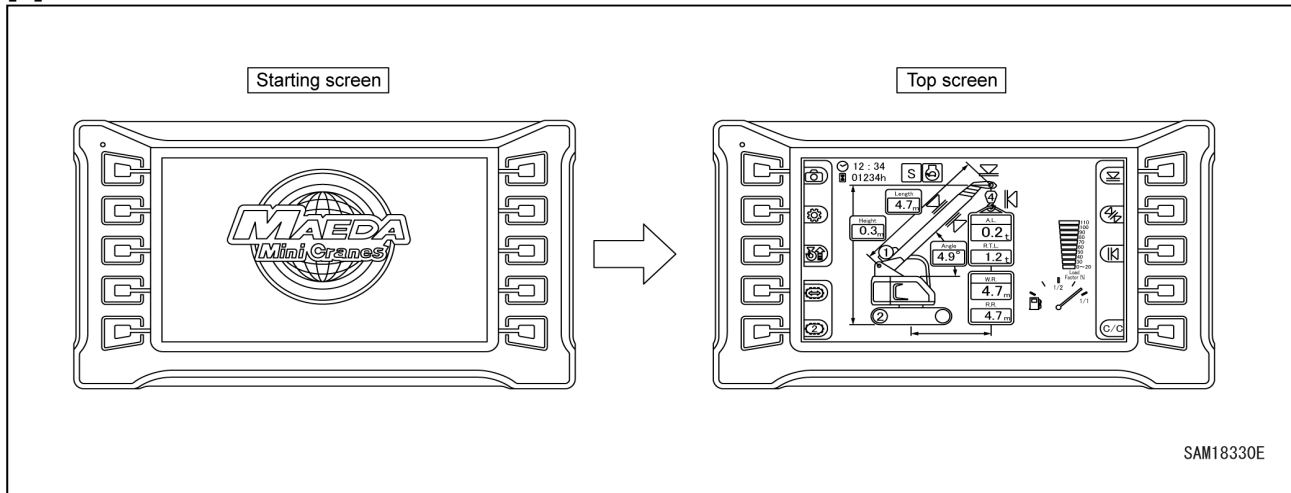

- When the starter switch is turned "ON", the starting screen is displayed.
- After the starting screen is displayed, the standby gauge is displayed and the screen is switched to the top screen.

#### NOTES

When the engine is started, the battery voltage can suddenly decrease depending on the temperature and battery condition.

In such a case, the machine monitor display can temporarily disappear, but this is normal.

[2] TOP SCREEN

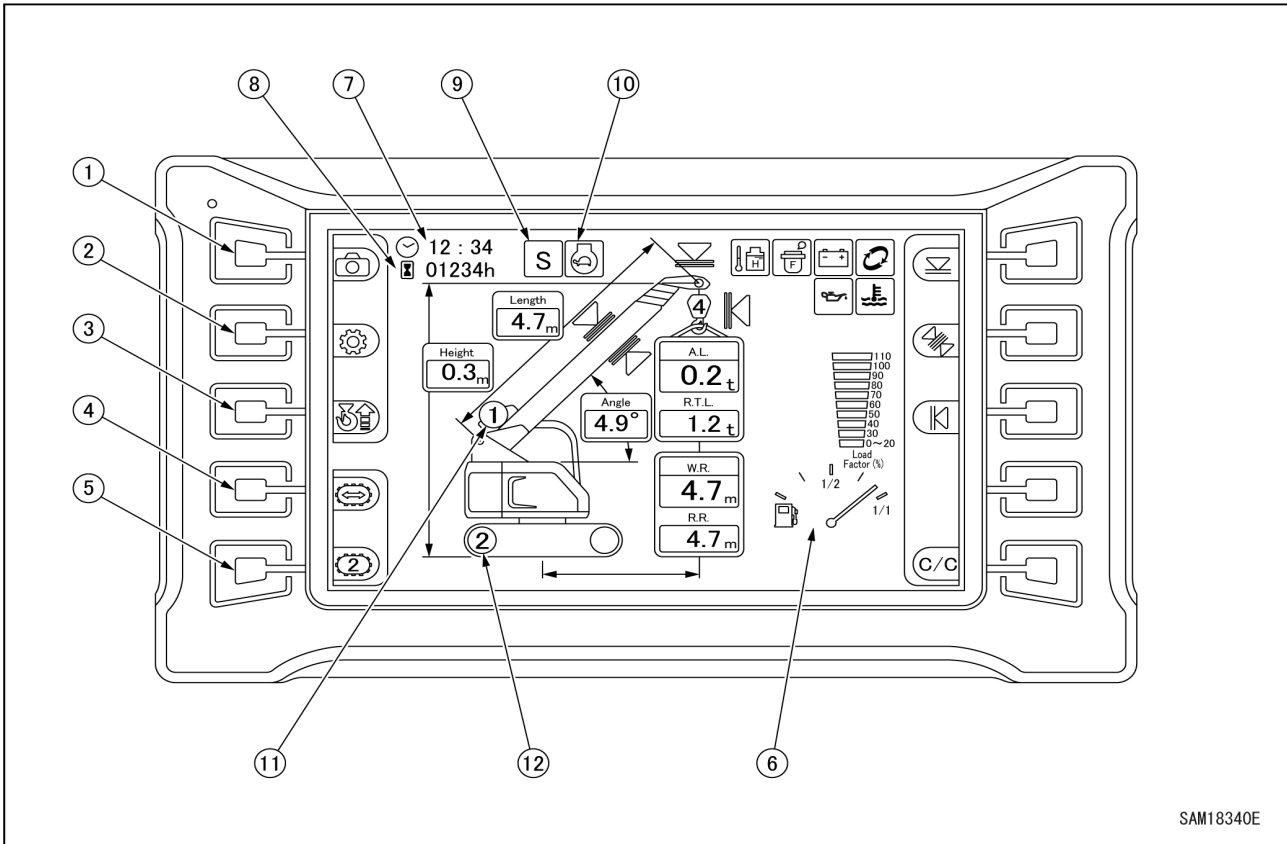

SAM18340E

- |  |   |
|--|---|
| (1) Rear view camera selector switch           | (7) Clock display                       |
| (2) User mode switch                           | (8) Hour meter display                  |
| (3) Hook storage switch                        | (9) Working mode display                |
| (4) Travel mode selector switch                | (10) Auto deceleration display          |
| (5) Travel 1st speed/2nd speed selector switch | (11) Winch 1st speed/2nd speed display  |
| (6) Fuel gauge                                 | (12) Travel 1st speed/2nd speed display |

See "OPERATION 2.4.4 MOMENT LIMITER FUNCTIONS" for the name of the moment limiter parts.

## 2.1.1 MONITOR BASIC ACTION AND DISPLAY

### [1] REAR VIEW CAMERA SELECTOR SWITCH

When the rear view camera selector switch (1) is pressed on the top screen, the camera image is displayed on the monitor.

When the home switch (HO) is pressed, the screen returns to the top screen.

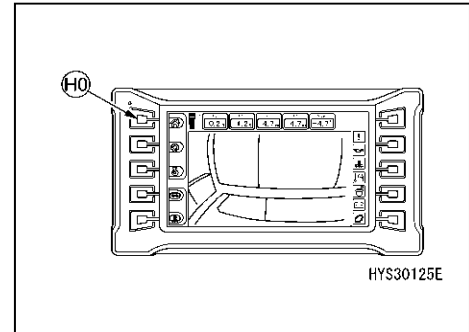

### NOTES

If it is difficult to see the camera image, adjust the camera angle.

### [2] USER MODE SWITCH

When the user mode switch (2) is pressed on the top screen, the user mode is displayed.

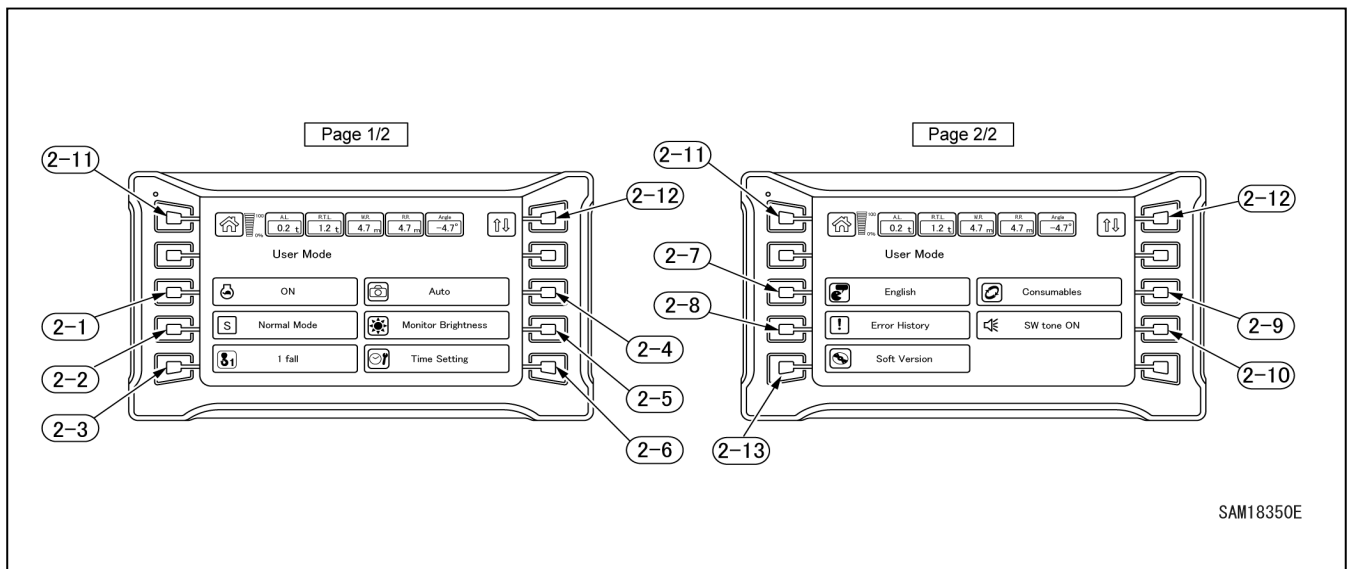

- (2-1) Auto deceleration ON/OFF change
- (2-2) Working mode change
- (2-3) Hook fall number change
- (2-4) Rear-view camera auto ON/OFF selector switch
- (2-5) Monitor brightness adjustment
- (2-6) Time setting screen

- (2-7) Language setting
- (2-8) Error history display
- (2-9) Consumables display
- (2-10) Switch operation sound ON/OFF change
- (2-11) Home switch
- (2-12) Display page change
- (2-13) Software version check

### [2-1] AUTO DECELERATION ON/OFF CHANGE

When the switch (2-1) is pressed, auto deceleration ON/OFF can be changed.

- OFF: Maintains constant engine speed even if you do not operate the controls for the preset duration.
- ON: Reduces engine speed if you do not operate the controls for the preset duration.

When ON is selected, the auto deceleration display (10) icon is displayed on the top screen.

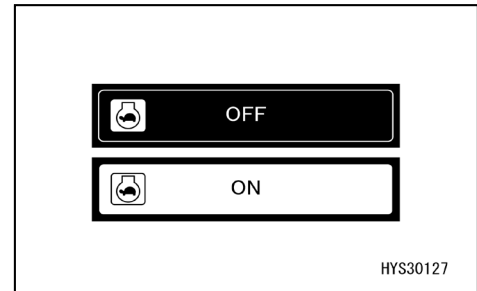

### [2-2] WORKING MODE CHANGE

When the switch (2-2) is pressed, the working mode can be changed.

- S: Standard mode
- E1: Eco mode 1 (fuel economy-focused mode)
- E2: Eco mode 2 (low revolution mode)

When the working mode is changed, the working mode display (9) on the top screen is changed.

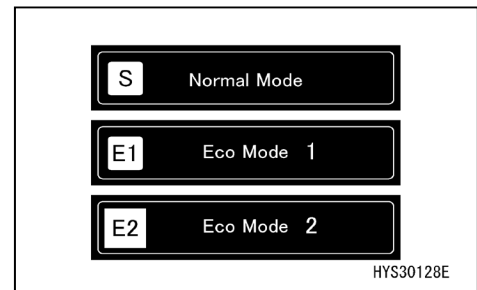

### [2-3] HOOK FALL NUMBER CHANGE

When the switch (2-3) is pressed and held, the hook fall number can be changed.

- Four falls
- Two falls
- One fall

When the fall number is changed, the number on the hook part of the moment limiter part changes and rated total load changes.

Be sure to match the displayed number with the actual hook fall number.

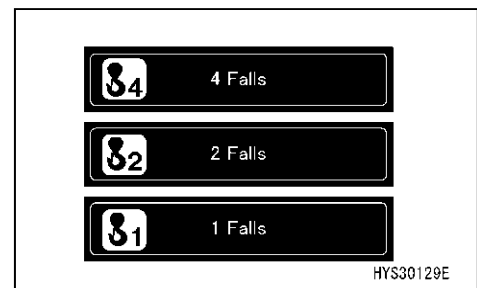

### [2-4] REAR VIEW CAMERA AUTO ON/OFF SELECTOR SWITCH

When the switch (2-4) is pressed, the rear view camera display mode can be switched between manual and automatic.

- Manual: Select the rear view camera display using the manual switch operation. The rear view camera display is not automatically selected, even during a crawling or slewing operation.
- Auto: Automatically selects the rear-view camera display during a crawling or slewing operation.

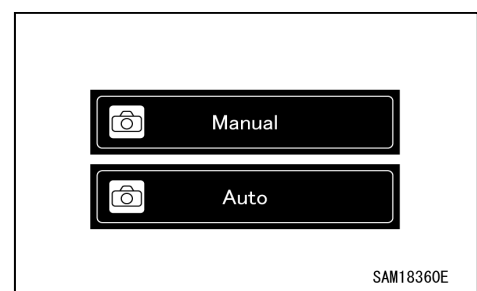





**[2-5] MONITOR BRIGHTNESS ADJUSTMENT**

When the switch (2-5) is pressed, the monitor brightness can be adjusted.

Make adjustments with ◀ or ▶ of the adjustment switch (2-5B).

The screen returns to the previous user mode screen with the home switch (2-5A).

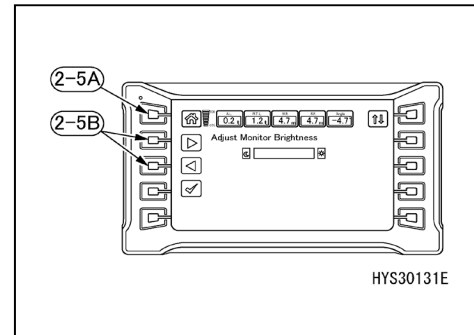

**[2-6] TIME SETTING SCREEN**

When the switch (2-6) is pressed, time setting, 24/12 hour display and summer time ON/OFF can be changed.

- Time setting
- 24/12 hour display change
- Summer time ON/OFF

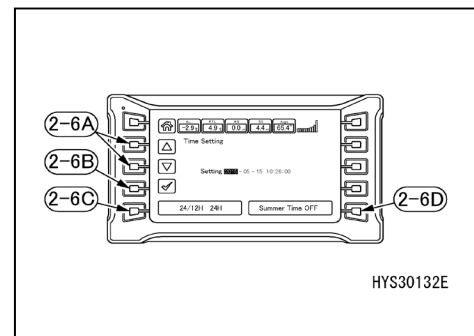

**[2-6-1] TIME SETTING**

Select the date and time desired to be changed with ◀ or ▶ of the adjustment switch (2-6A) and press the check mark (2-6B).

(The part whose background is white is selected.)

When the word color turns red, editing becomes possible.

Make adjustments with ◀ or ▶ of the adjustment switch (2-6A) in this condition.

When the check mark (2-6B) is finally pressed, editing is completed.

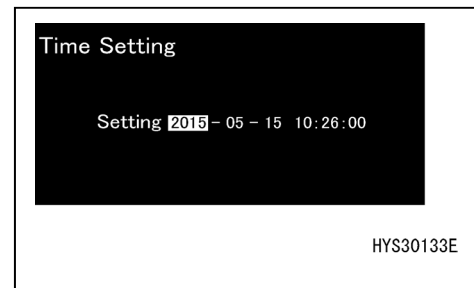

**[2-6-2] 24/12 HOUR DISPLAY CHANGE**

When the switch (2-6C) is pressed, time display can be changed to either 24 hour display or 12 hour display.

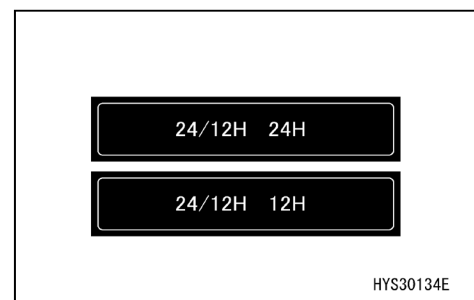

**[2-6-3] SUMMER TIME ON/OFF**

When the switch (2-6D) is pressed, ON or OFF of summer time can be selected.

- ON: Time display is moved up by one hour.
- OFF: Originally set time is displayed.

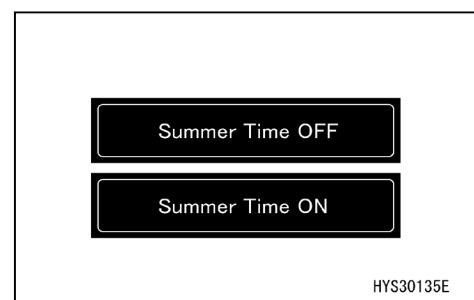



**[2-7] LANGUAGE SETTING**

When the switch (2-7) is pressed, the language can be changed if there are alternatives of the display language.

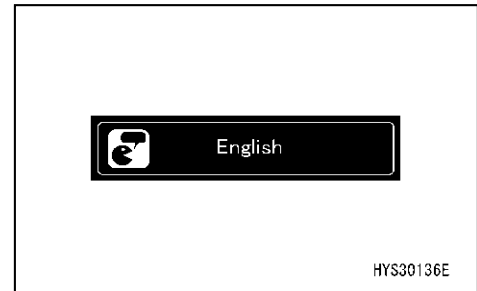

**[2-8] ERROR HISTORY DISPLAY**

When the switch (2-8) is pressed, the error history can be viewed.

If a fault occurs now, it is displayed in red characters. See "OPERATION 2.1.2 "WARNING DISPLAY" for details.

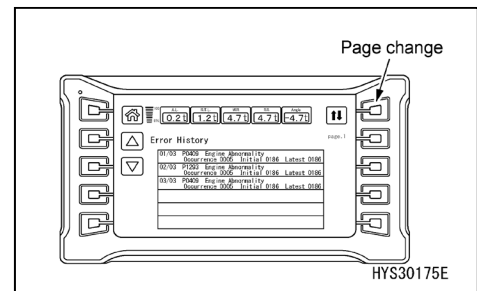

**[2-9] CONSUMABLES DISPLAY**

When the switch (2-9) is pressed, the list of consumables can be viewed.

After replacing a consumable item, use ▲ or ▼ of the adjustment switch (2-9A) to select the replaced item. You can also use the page selector switch (2-9D) to select the required page.

Once you've selected a consumable item, hold down the replacement switch (2-9B) and update the replacement time. Once updated, the number of replacements is incremented by 1, while the remaining time is reset.

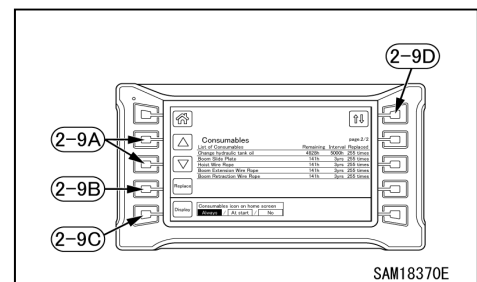

<b>NOTES</b>	
<p>The message "Did you replace winch reduction gear?" will appear when you replace the winch reduction gear case oil. Select "Yes" or "No", as appropriate.</p>	

Did you replace winch reduction gear?

Yes /  No

SAM18380E

If the consumables icon display selector (2-9C) is set to "Always" or "At start", the remaining time of 30 hours or 3 days will appear as yellow text with a white-on-dark icon on the top screen, while the remaining time of 0 hours or 0 days will appear as red text with a red icon on the top screen.

Replace these items promptly. Ignoring scheduled replacements may generate hazards or adversely affect the machinery.

Consumables icon on home screen

Always /  At start /  No

SAM18390E



## NOTES

**We recommend setting the consumables icon display selector (2-9C) to "Always".**

**The consumables icon display changes as follows when the replacement time approaches or when the replacement time is exceeded based on the setting made.**

**Always:** The consumables icon is always displayed on the top screen.

**At start:** The icon is displayed for just 30 seconds on the top screen after startup.

**No:** The consumables icon is not displayed.

### [2-10] SWITCH OPERATION SOUND ON/OFF CHANGE

When the switch (2-10) is pressed, switch operation sound ON/OFF can be changed.

- OFF: The operation sound is disabled.
- ON: The operation sound is enabled.

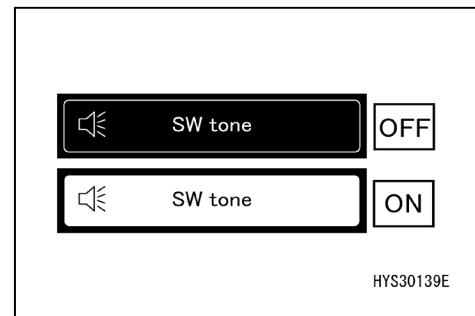

### [2-11] HOME SWITCH

- Short-time pressing : Returns one page.
- Long-time pressing : Returns to the top screen.

### [2-12] DISPLAY PAGE CHANGE

Each time the switch is pressed, the page changes: "1/2 page to 2/2 page to 1/2 page".

### [2-13] SOFTWARE VERSION CHECK

The controller software version can be checked.

### [3] HOOK STORAGE SWITCH

#### **! WARNING**

- **The hook storage switch cancels the automatic stop function of the overwinding prevention device.**  
**When storing the hook block, carefully operate the right work equipment operation lever and pay due attention not to allow the hook block to crash against the boom.**
- **Use the hook storage switch only when performing simple storage of the hook block in the boom tip.**

While continuing to press the switch (3), operate the right work equipment operation lever toward the "Hoisting" side. The hook block is hoisted and is stored in the storage section of the boom tip.

When the switch is released, the automatic stop function of the overwinding prevention device turns into an operating state.

### NOTES

- While this switch is pressed, the red lamp of the rotating warning lamp illuminates.
- When the winch is hoisted while this switch is pressed, the hoisting speed becomes slow, which is not a fault.

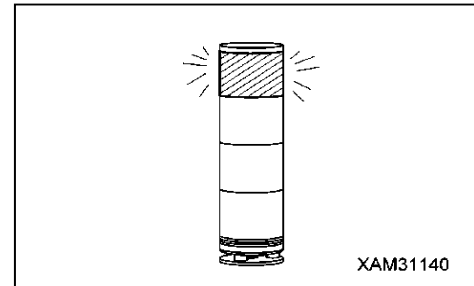

#### [4] TRAVEL MODE SELECTOR SWITCH

### ⚠ DANGER

Travel with a lifted load is in principle not advised because it is very unstable and involves danger.

If travel with a lifted load is unavoidably performed, see "OPERATION 3.24 OPERATION DURING TRAVELLING HOIST " and strictly observe the rated total load, operation method and travel posture with a lifted load at the time of travel with a lifted load.

Unless these precautions in travelling with a lifted load are observed, serious physical injury may be caused.

When the switch (4) is pressed, the mode can be changed from the stationary mode to the travel mode enabling travel with a lifted load.

The display of the machine body illustration on the top screen changes.

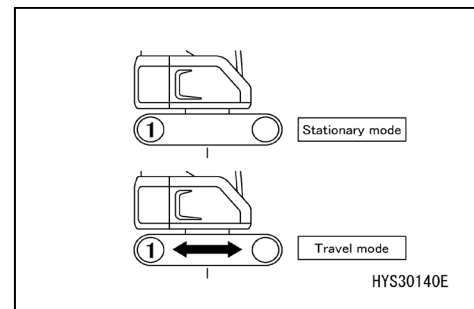

#### [5] TRAVEL 1ST SPEED/2ND SPEED SELECTOR SWITCH

### ⚠ WARNING

- Be sure to perform loading to and unloading from a trailer at low speed ("set to 1st speed"). While travelling, never perform changing operation of the travel speed selector switch.
- If changing operation of high/low speed (2nd speed - 1st speed) is performed during travelling, the travel direction may deviate even while travelling in a straight line. Perform changing operation of travel speed after stopping the machine.
- The rear of the machine body is a blind spot. Be sure to check the rear of the machine body with a rear view camera before performing backward travel operation.

The switch (5) changes the travel speed into two stages. Each time the switch is pressed, the speed changes from "1st speed" to "2nd speed" to "1st speed" repeatedly.

- Display of monitor "1": Low speed travel (1st speed)
- Display of monitor "2": High speed travel (2nd speed)

The display (12) on the top screen changes.

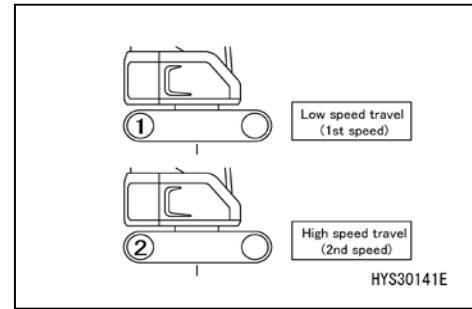

### NOTES

- When the actual load value of the moment limiter is 0.5ton or more, the machine does not travel at high speed even if "2" is displayed on the monitor.

### [6] FUEL GAUGE

The meter (6) indicates the fuel quantity in the fuel tank. When the indicator comes near the red color of the meter, check the fuel quantity in the fuel tank and replenish fuel.

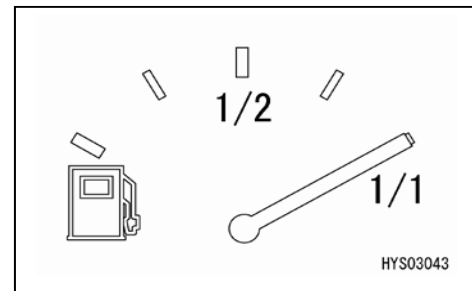

### NOTES

Although the indicator may not point to the correct position for a while after the starter switch is turned "ON", this is normal.

### [7] CLOCK DISPLAY

Displays the time.

### [8] HOUR METER DISPLAY

Displays the hour meter.

### [9] WORKING MODE DISPLAY

Displays the working mode currently set.

### [10] AUTO DECELERATION DISPLAY

This is displayed when Auto deceleration is ON.

### [11] WINCH 1ST SPEED/2ND SPEED DISPLAY

Each time the winch 1st speed/2nd speed selector switch is pressed, the speed changes "from 1 to 2 to 1".

### [12] TRAVEL 1ST SPEED/2ND SPEED DISPLAY

Each time the travel 1st speed/2nd speed selector switch is pressed, the speed changes "from 1 to 2 to 1".



## 2.1.2 WARNING DISPLAY

### [1] WARNING DISPLAY AND ERROR CODE DISPLAY

#### ⚠ CAUTION

If the warning monitor illuminates in red, immediately stop the work and stop the engine or set it to low idle. Then, immediately inspect the applicable part and take the correct action.

Emergency stop items are those to which you have to pay attention during engine running and when an abnormality occurs, items for which immediate action must be taken are displayed. When an abnormality occurs, the monitor of the abnormal part illuminates in red and the buzzer sounds.

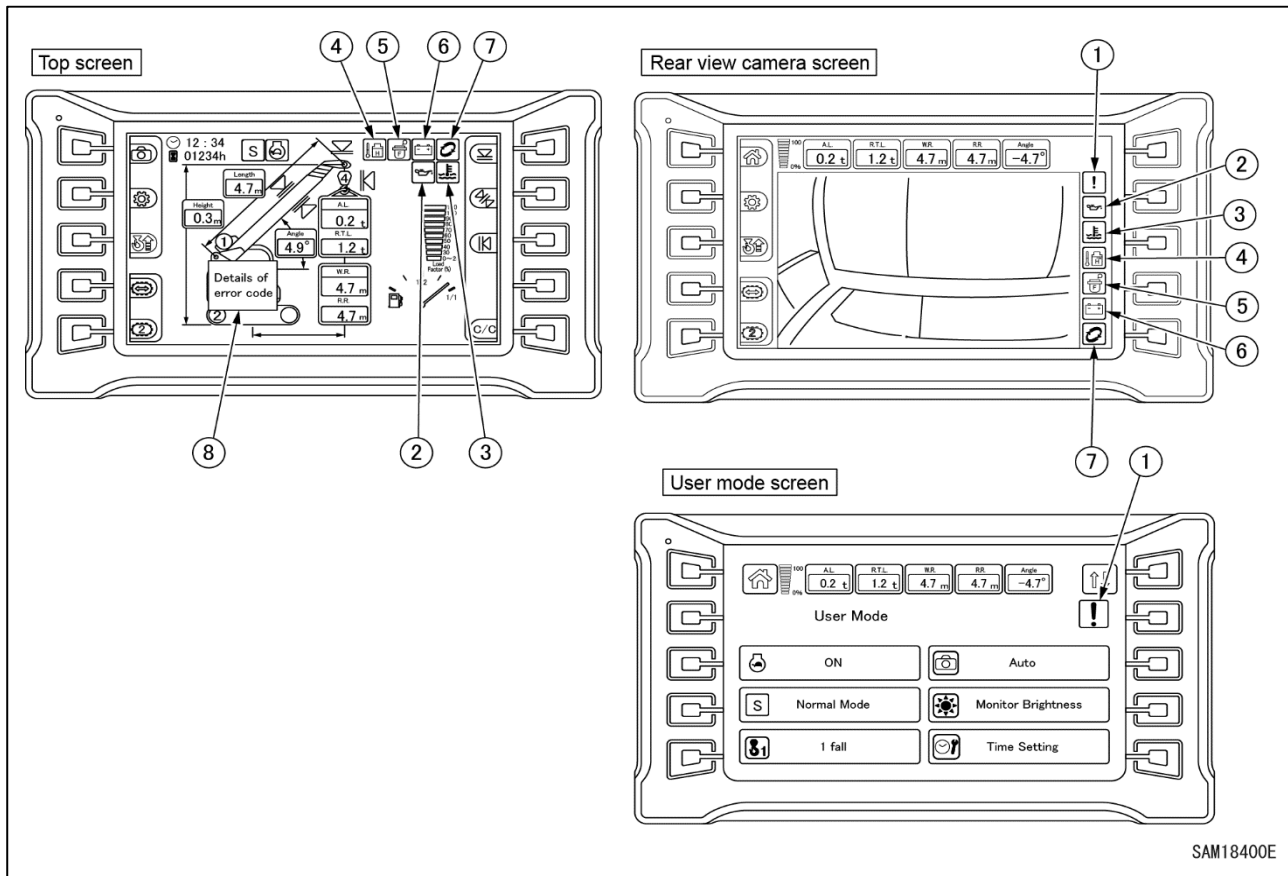

- (1) Abnormality display (abnormality detected)
- (2) Engine oil pressure abnormality
- (3) Engine coolant temperature abnormality
- (4) Hydraulic oil temperature abnormality

- (5) Fuel clogging abnormality
- (6) Charged capacity display
- (7) Consumables display
- (8) Error code display

If a warning and/or error code is displayed, check the warning content and error content.



If an error code is displayed, please contact us or our sales and service agency.



**[2] LIST OF ERROR CODES**

If the following error codes are displayed, see "Operation 8. Action in the case of abnormality". If you think there is another reason, ask us or our sales service agency for repair.





Error code	Monitor display Item	Alarm buzzer	Content
EO01L	Output Abnormality		Pump SOL Open
EO01H	Output Abnormality		Pump SOL Short
EO02L	Boom Down SOL Open	●	Boom Down SOL Open
EO02H	Boom Down SOL Short	●	Boom Down SOL Short
EO03L	Boom Raise SOL Open	●	Boom Raise SOL Open
EO03H	Boom Raise SOL Short	●	Boom Raise SOL Short
EO04L	Extend SOL Open	●	Extend SOL Open
EO04H	Extend SOL Short	●	Extend SOL Short
EO05L	Output Abnormality		Travel Shift SOL Open
EO05H	Output Abnormality		Travel Shift SOL Short
EO06L	Output Abnormality		Low Pressure Shift SOL Open
EO06H	Output Abnormality		Low Pressure Shift SOL Short
EO07L	Output Abnormality		Hoist Up Merge SOL Open
EO07H	Output Abnormality		Hoist Up Merge SOL Short
EO08L	Output Abnormality		Winch High Speed SOL Open
EO08H	Output Abnormality		Winch High Speed SOL Short
EO09L	Output Abnormality		Hoist Up Stop SOL Open
EO09H	Output Abnormality		Hoist Up Stop SOL Short
EO10L	Output Abnormality		Hoist Down Stop SOL Open
EO10H	Output Abnormality		Hoist Down Stop SOL Short
EO11L	Output Abnormality		Slew Parking Brake SOL Open
EO11H	Output Abnormality		Slew Parking Brake SOL Short
EO12L	Output Abnormality		Travel PPC SOL Open
EO12H	Output Abnormality		Travel PPC SOL Short
ES01L	Sensor 12V Power Abnormality (Low Voltage Abnormality)	●	Sensor 12V Power Abnormality (Low Voltage Abnormality)
ES01H	Sensor 12V Power Abnormality (High Voltage Abnormality)	●	Sensor 12V Power Abnormality (High Voltage Abnormality)
ES02L	Derrick Pressure Sensor 1 Voltage Abnormality (Low voltage abnormality)	●	Derrick Pressure Sensor 1 Voltage Abnormality (Low voltage abnormality)
ES02H	Derrick Pressure Sensor 1 Voltage Abnormality (High voltage abnormality)	●	Derrick Pressure Sensor 1 Voltage Abnormality (High voltage abnormality)
ES03L	Derrick Pressure Sensor 2 Voltage Abnormality (Low voltage abnormality)	●	Derrick Pressure Sensor 2 Voltage Abnormality (Low voltage abnormality)
ES03H	Derrick Pressure Sensor 2 Voltage Abnormality (High voltage abnormality)	●	Derrick Pressure Sensor 2 Voltage Abnormality (High voltage abnormality)
ES04L	Length Sensor Voltage Abnormality (Low Voltage Abnormality)	●	Length Sensor Voltage Abnormality (Low Voltage Abnormality)
ES04H	Length Sensor Voltage Abnormality (High Voltage Abnormality)	●	Length Sensor Voltage Abnormality (High Voltage Abnormality)
ES05L	Angle Sensor Voltage Abnormality (Low Voltage Abnormality)	●	Angle Sensor Voltage Abnormality (Low Voltage Abnormality)
ES05H	Angle Sensor Voltage Abnormality (High Voltage Abnormality)	●	Angle Sensor Voltage Abnormality (High Voltage Abnormality)
ES06L	Sensor Abnormality		Pump Pressure Sensor 1 Voltage Abnormality (Low Voltage Abnormality)
ES06H	Sensor Abnormality		Pump Pressure Sensor 1 Voltage Abnormality (High Voltage Abnormality)
ES07L	Sensor Abnormality		Pump Pressure Sensor 2 Voltage Abnormality (Low Voltage Abnormality)
ES07H	Sensor Abnormality		Pump Pressure Sensor 2 Voltage Abnormality (High Voltage Abnormality)
ES08L	Sensor Abnormality		Pump Pressure Sensor 3 Voltage Abnormality (Low Voltage Abnormality)
ES08H	Sensor Abnormality		Pump Pressure Sensor 3 Voltage Abnormality (High Voltage Abnormality)
ES09L	Sensor Abnormality		PPC Pressure Sensor Voltage Abnormality (Low Voltage Abnormality)
ES09H	Sensor Abnormality		PPC Pressure Sensor Voltage Abnormality (High Voltage Abnormality)
ES10L	Sensor Abnormality		Hydraulic Oil Temperature Sensor Voltage Abnormality (Low Voltage Abnormality)
ES10H	Sensor Abnormality		Hydraulic Oil Temperature Sensor Voltage Abnormality (High Voltage Abnormality)
ES11L	Inclination Sensor Voltage Abnormality (Low Voltage Abnormality)	●	Inclination Sensor Voltage Abnormality (Low Voltage Abnormality)
ES11H	Inclination Sensor Voltage Abnormality (High Voltage Abnormality)	●	Inclination Sensor Voltage Abnormality (High Voltage Abnormality)
ES12L	Sensor Abnormality		Accelerator Pedal Voltage Abnormality (Low Voltage Abnormality)
ES12H	Sensor Abnormality		Accelerator Pedal Voltage Abnormality (High Voltage Abnormality)
ES13H	Sensor Abnormality		Fuel Sensor Resistance Abnormality (High Resistance Abnormality)
ES14L	Sensor Abnormality		Sensor 24V Power Abnormality (Low Voltage Abnormality)
ES14H	Sensor Abnormality		Sensor 24V Power Abnormality (High Voltage Abnormality)
TTC36	Controller Abnormality	●	TTC36 Communication Abnormality
EV001	Battery Voltage Abnormality	●	Battery Voltage Abnormality
EV002	Voltage Abnormality		TTC60 Sensor Power 5V1 Abnormality
EV003	Voltage Abnormality		TTC60 Sensor Power 5V2 Abnormality
EV004	Voltage Abnormality		TTC60 Sensor Power 10V Abnormality
EV005	Voltage Abnormality		TTC36 Sensor Power 5V1 Abnormality
EV006	Voltage Abnormality		TTC36 Sensor Power 5V2 Abnormality
EV007	Alternator Abnormality	●	Alternator Abnormality
EH01	Hydraulic Oil Temperature Abnormality	●	Hydraulic Oil Temperature Abnormality

Alarm	 EV001 Battery Voltage Abnormality EV007 Alternator Abnormality	 EH01 Hydraulic Oil Temperature Abnormality	 Other errors
-------	---	---	--





Monitor display		Alarm buzzer	Content
Error code	Item		
P0340	Engine Abnormality		Cam Sensor Abnormality (No Signal)
P0335	Engine Abnormality		Crank Sensor Abnormality (No Signal)
P0336	Engine Abnormality		Crank Sensor Abnormality (Signal Abnormality)
P0016	Engine Abnormality		Cam Sensor Phase Gap
P0113	Engine Abnormality		Air Intake Temperature Sensor Abnormality (High Voltage Abnormality)
P0112	Engine Abnormality		Air Intake Temperature Sensor Abnormality (Low Voltage Abnormality)
P0118	Engine Abnormality		Water Temperature Sensor Abnormality (High Voltage Abnormality)
P0117	Engine Abnormality		Water Temperature Sensor Abnormality (Low Voltage Abnormality)
P0098	Engine Abnormality		Manifold Temperature Sensor (IMT) Abnormality (High Voltage Abnormality)
P0097	Engine Abnormality		Manifold Temperature Sensor (IMT) Abnormality (Low Voltage Abnormality)
P0238	Engine Abnormality		Boost Pressure Sensor Abnormality (High Pressure Abnormality)
P0237	Engine Abnormality		Boost Pressure Sensor Abnormality (Low Pressure Abnormality)
P0409	Engine Abnormality		EGR Position Sensor Abnormality
P2229	Engine Abnormality		Atmospheric Pressure Sensor Abnormality (High Voltage Abnormality)
P2228	Engine Abnormality		Atmospheric Pressure Sensor Abnormality (Low Voltage Abnormality)
P0183	Engine Abnormality		Fuel Temperature Sensor Abnormality (High Voltage Abnormality)
P0182	Engine Abnormality		Fuel Temperature Sensor Abnormality (Low Voltage Abnormality)
P20E0	Engine Abnormality		Fuel Filter Clogging Sensor Abnormality (High Voltage Abnormality)
P20DF	Engine Abnormality		Fuel Filter Clogging Sensor Abnormality (Low Voltage Abnormality)
P0193	Engine Abnormality		Common Rail Pressure Sensor (High Voltage Abnormality)
P0192	Engine Abnormality		Common Rail Pressure Sensor (Low Voltage Abnormality)
P0523	Engine Abnormality		Engine Oil Pressure Sensor Abnormality High Voltage Abnormality
P0522	Engine Abnormality		Engine Oil Pressure Sensor Abnormality Low Voltage Abnormality
P1098	Engine Abnormality		Boost Temperature Sensor Abnormality High Voltage Abnormality
P1097	Engine Abnormality		Boost Temperature Sensor Abnormality Low Voltage Abnormality
P0404	Engine Abnormality		EGR Valve Control Abnormality
P1404	Engine Abnormality		EGR Zero Point Learning Abnormality
P0092	Engine Abnormality		SCV Drive System +B Short
P0091	Engine Abnormality		SCV Drive System Open, GND Short
P0201	Engine Abnormality		Injection Nozzle # 1 Drive System Circuit Open
P0202	Engine Abnormality		Injection Nozzle # 2 Drive System Circuit Open
P0203	Engine Abnormality		Injection Nozzle # 3 Drive System Circuit Open
P0204	Engine Abnormality		Injection Nozzle # 4 Drive System Circuit Open
P0089	Engine Abnormality		Common Rail Pressure Abnormality Pump Pressure Over Feed
P0087	Engine Abnormality		Pressure Limiter Open
P1093	Engine Abnormality		Common Rail Pressure Low Pumping Shortage
P0093	Engine Abnormality		Common Rail Pressure Low No Pumping
P0217	Overheat	●	Overheat
P0219	Engine Abnormality		Overrun
P0521	Engine Oil Pressure Low	●	Engine oil Pressure Low Abnormality
P20DE	Fuel Clogging	●	Fuel Filter Clogging (First Stage)
P2540	Fuel Clogging	●	Fuel Filter Clogging (Second Stage)
P0380	Engine Abnormality		Glow Relay Abnormality
P0615	Engine Abnormality		Starter Cut Relay Abnormality
P0685	Engine Abnormality		Main Relay System Abnormality (Stay Opened)
P0687	Engine Abnormality		Main Relay System Abnormality (Stay Closed)
P0563	Engine Abnormality		Battery System High Voltage Abnormality
P1261	Engine Abnormality		Charge Circuit Abnormality (Bank 1)
P1262	Engine Abnormality		Charge Circuit Abnormality (Bank 2)
P06AF	Engine Abnormality		Injector IC Abnormality
P06AF	Engine Abnormality		Injector IC Checksum Abnormality
P06AF	Engine Abnormality		Injector IC Communication Abnormality
P1606	Engine Abnormality		SWITCH-IC 1 Internal Abnormality
P1606	Engine Abnormality		SWITCH-IC 1 Communication Abnormality
P060B	Engine Abnormality		A/D Conversion Abnormality
P160B	Engine Abnormality		ADIC Abnormality
P0606	Engine Abnormality		CPU Abnormality
P0606	Engine Abnormality		CPU Monitoring IC Abnormality
P0601	Engine Abnormality		ROM Abnormality
P1621	Engine Abnormality		EEPROM Abnormality
P0641	Engine Abnormality		5V Power 1 Voltage Abnormality
P0651	Engine Abnormality		5V Power 2 Voltage Abnormality
P0697	Engine Abnormality		5V Power 3 Voltage Abnormality
P1655	Engine Abnormality		5V Power 4 Voltage Abnormality
P0604	Engine Abnormality		RAM Abnormality
P0602	Engine Abnormality		QR Code Abnormality
P2146	Engine Abnormality		Injection Nozzle Common 1 Drive System Abnormality
P2149	Engine Abnormality		Injection Nozzle Common 2 Drive System Abnormality
P0073	Engine Abnormality		CAN Bus Abnormality
P0101	Engine Abnormality		CAN Timeout Abnormality

Alarm display		P0217 Overheat		P0521 Engine oil Pressure Low Abnormality
		P20DE Fuel Filter Clogging (First Stage)		P2540 Fuel Filter Clogging (Second Stage)
				Other errors

## 2.2 SWITCHES

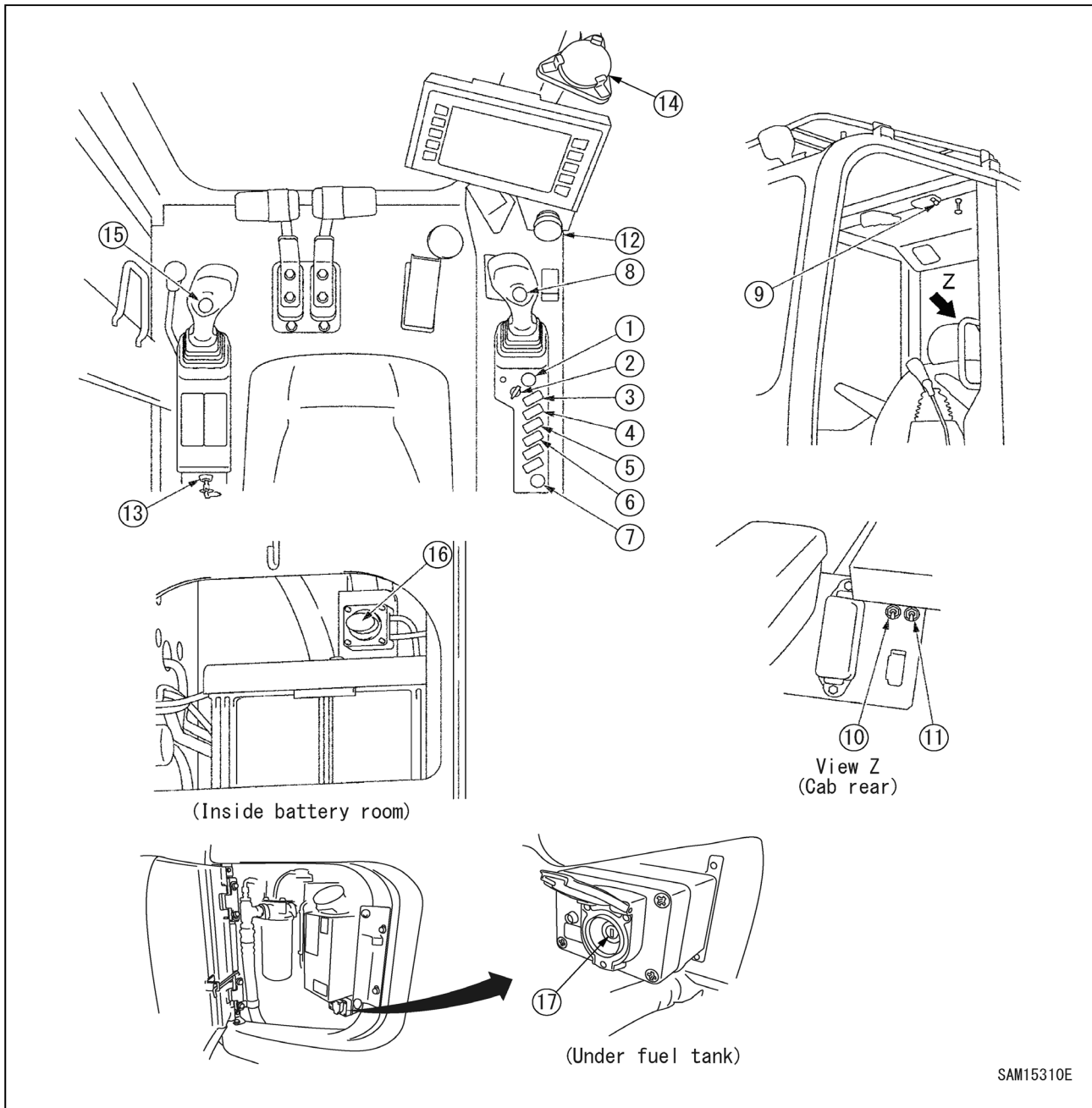

- |                               |  |
|-------------------------------|--|
| (1) Starter switch            | (10) Emergency accelerator driving switch (with guard)             |
| (2) Fuel adjustment dial      | (11) Slewing parking brake emergency canceling switch (with guard) |
| (3) Lamp switch               | (12) Emergency stop switch   |
| (4) Front window wiper switch | (13) Maintenance switch  |
| (5) Roof window wiper switch  | (14) Levelling instrument  |
| (6) Buzzer canceling switch   | (15) Winch 2 speed selector switch                                 |
| (7) Accessory power supply    | (16) Disconnect switch   |
| (8) Horn switch               | (17) Override switch   |
| (9) Room lamp switch          |  |



**[1] STARTER SWITCH**

**⚠ CAUTION**

Always turn the starter switch to the "OFF" position at the end of work.

Use this switch to start and stop the engine.

- OFF  
The key can be inserted and removed, the electrical system current is turned off except the room lamp and the engine stops.
- ON  
Electricity flows through the charging circuit and lamp circuit. Keep the switch at this position while the engine is running.
- START  
A position where the engine starts. Keep the key at this position during cranking and when the engine has started, immediately release your hand from the key. The key automatically returns to the "ON" position.  
The engine of this machine has the automatic remaining heat function. If the engine does not crank when it is cold, AUTO GLOW lamp illuminates. When the lamp illuminates, wait until the lamp goes out and then, turn the switch to the START position to start the engine.

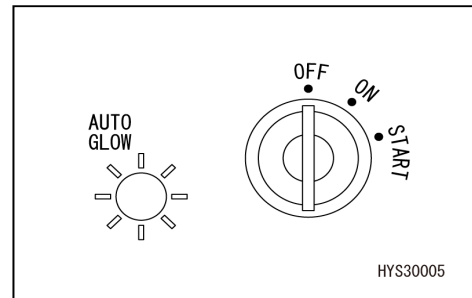
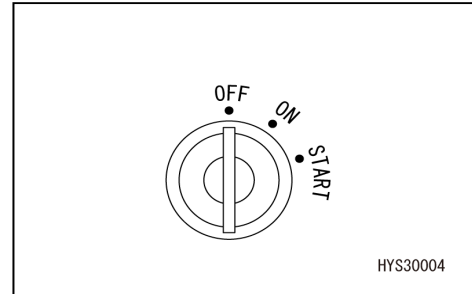

**NOTES**

The engine does not start unless the lock lever is at the lock (L) position. Check that the lock lever is at the lock (L) position before operating the starter switch.

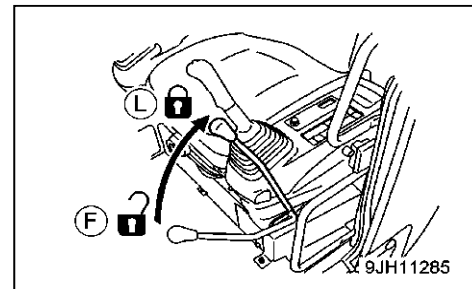

**[2] FUEL ADJUSTMENT DIAL**

Adjusts the engine speed and output.

- (a) Low idling (MIN): Position where the dial is fully turned counterclockwise (left direction)
- (b) Full revolution (MAX): Position where the dial is turned clockwise (right direction)

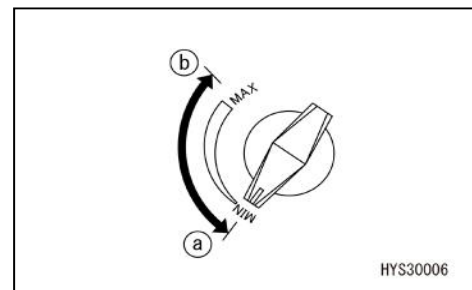

### [3] LAMP SWITCH

Use this switch to turn on the working lamp and headlamps.

- (a) ON position: The lamp turns on.
- (b) OFF position: The lamp turns off.

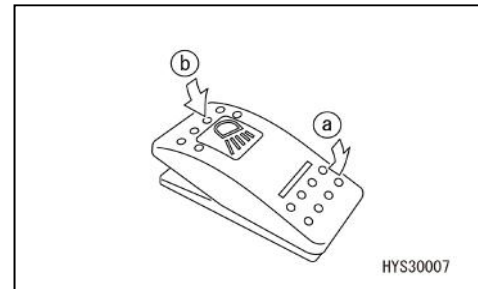

### [4] FRONT WINDOW WIPER SWITCH

Use this switch to activate the wiper of the cab front window and window washer fluid.

- (a) Wiper position: The wiper operates.
- (b) Washer position:
  - When the switch continues to be pressed, washer fluid is emitted and the wiper operates.
  - When you release your hand from the switch, the switch returns, washer fluid stops and the wiper also stops.
- (c) Stop position: The wiper stops.

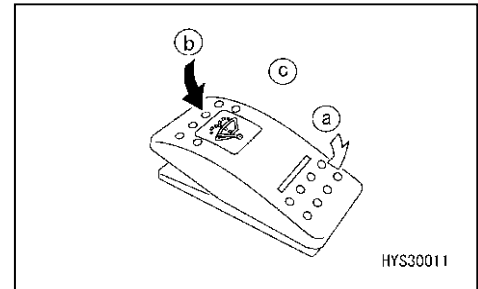

### [5] ROOF WINDOW WIPER SWITCH

Use this switch to activate the wiper of the cab roof. window and window washer fluid.

- (a) Wiper position: The wiper operates.
- (b) Washer position:
  - When the switch continues to be pressed, washer fluid is emitted and the wiper operates.
  - When you release your hand from the switch, the switch returns, washer fluid stops and the wiper also stops.
- (c) Stop position: The wiper stops.

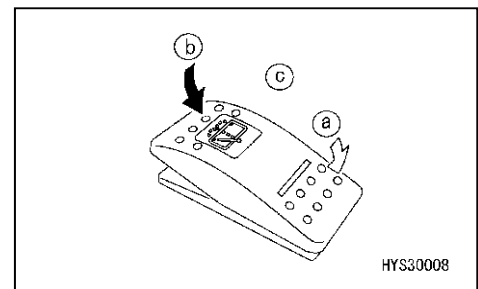

### [6] BUZZER CANCELING SWITCH

For your safety, set the switch to the normal position for work.

- (a) Cancel position:
  - The warning buzzer sound is stopped.
- (b) Normal position:
  - The warning buzzer tone sounds.

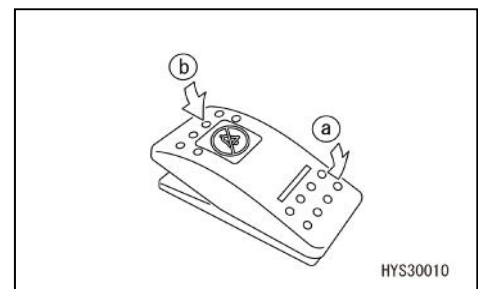

## NOTES

The buzzer tone which can be cancelled is limited to the buzzer tone when a fault code is displayed. Other warning sounds are not cancelled.

**[7] ACCESSORY POWER SUPPLY**

**CAUTION**

Accessory power supply is for 24V. Do not use this as power supply for equipment of 12V.

This can be used as an accessory socket. (100W (24V x 5A))

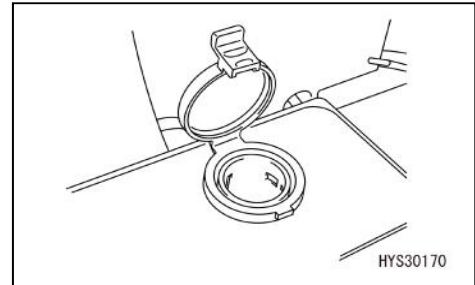

**[8] HORN SWITCH**

Use this switch to honk the horn.

When the switch on the knob part of the right work equipment operation lever is pressed, the horn honks.

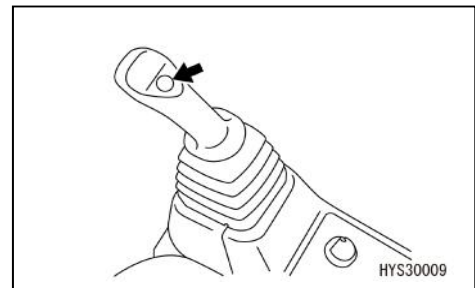

**[9] ROOM LAMP SWITCH**

**CAUTION**

Failure to turn off the switch causes the battery to be discharged. Be sure to turn the switch to the "OFF" position after using the room lamp. The room lamp turns on when the starter switch is at the "OFF" position.

Use this switch to turn on the room lamp.

- (a) "ON" position: The room lamp turns on.
- (b) "OFF" position: The room lamp turns off.

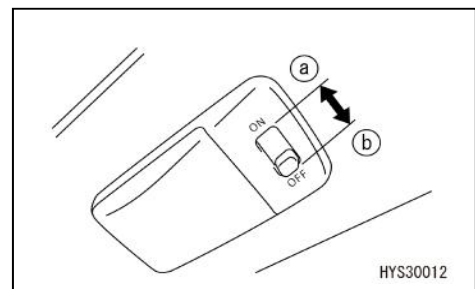

**[10] EMERGENCY ACCELERATOR DRIVING SWITCH**

**CAUTION**

**Use this switch to increase the engine speed temporarily when accelerator revolution does not increase because of an abnormality in the electrical system.**

Use this switch to perform work temporarily when an abnormality occurs in the accelerator control system.

- (a) "Emergency" position: Abnormal case (switch raising)  
+ buzzer sounding and display on the monitor
- (b) "Normal" position: Normal case (switch lowering)

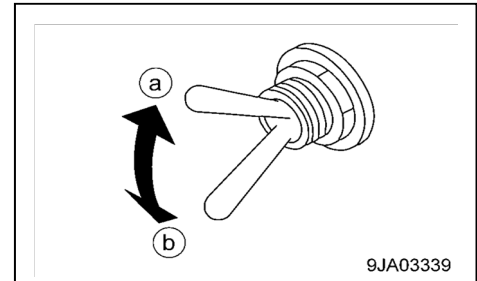

9JA03339

**NOTES**

When the switch is turned to the (a) "Emergency" position in the normal case, the engine abnormality (P0101) error is displayed on the monitor even if the switch is returned to the (b) "Normal" position. However, this is not a fault.

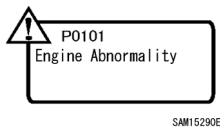

← Error displayed on the monitor  
(Not a fault)

In this case, take the following steps to delete the error display.

1. Turn the switch to the (b) "Normal" position.
2. Start the engine and operate it at least for one minute.
3. Turn OFF the starter switch and stop the engine at least for one minute.
4. Repeat the steps 2 and 3 again. (Twice each in total)
5. When the above operation is performed, the engine abnormality (P0101) display on the monitor disappears.

If these steps fail to clear the error, contact us or our sales service agency.

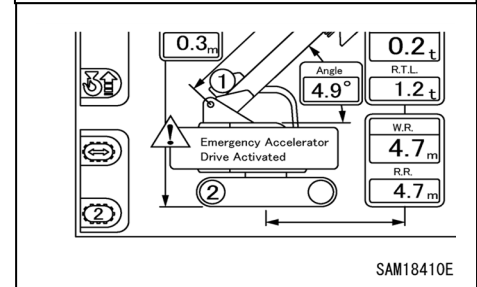

SAM18410E

[11] SLEWING PARKING BRAKE EMERGENCY CANCELING SWITCH

**CAUTION**

This enables slewing operation temporarily when the controller is abnormal. Do not use this switch except in the abnormal case. Promptly repair the abnormal area.

Use this switch to perform slewing operation temporarily when an abnormality occurs.

- (a) "Release" position: Abnormal case (switch raising) + buzzer sounding and display on the monitor
- (b) "Normal" position: Normal case (switch lowering)

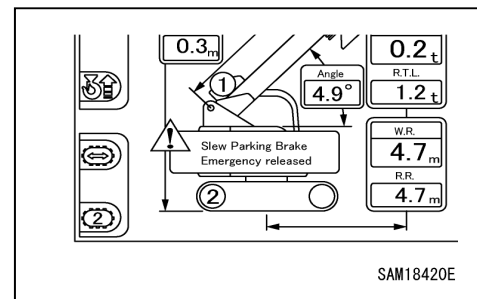
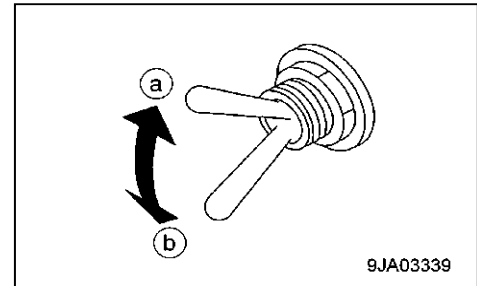



**[12] EMERGENCY STOP SWITCH**

Use this switch to stop the engine urgently.

- ON: Press the switch. The engine stops.  
"Emergency stop" is displayed on the upper right of the monitor.
- OFF: Turn the switch clockwise (in the arrow direction on the right illustration).  
The switch returns to the original position.

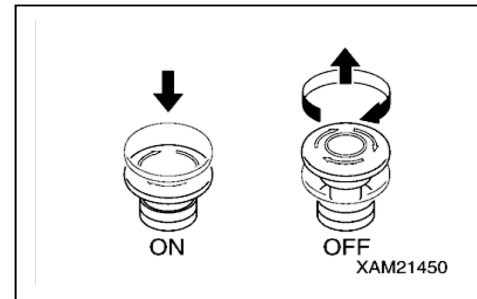

**NOTES**

When restarting the engine after an emergency stop, be sure to turn the EMO switch to the "OFF" position before starting the engine.

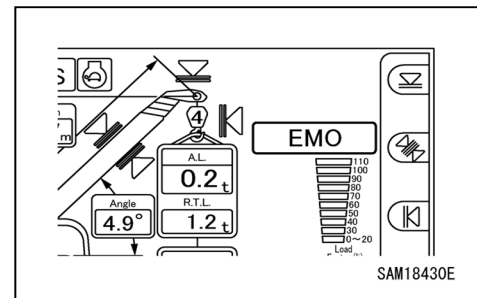

**[13] MAINTENANCE SWITCH**

This switch is not used for crane operations.  
It is a maintenance switch for servicing.

**[14] LEVELLING INSTRUMENT**

**⚠ WARNING**

**If crane operation is performed with the machine tilted, it may cause tripping.**  
**Find a place, whilst looking at the levelling instrument, where the machine body is in a level state before starting crane operation.**  
**If work is unavoidably performed on a slope, place planking or lay earth on the ground to make the ground level.**

This displays an inclination status of the machine.  
The inclination and direction of the machine can be determined from the position of the air bubbles.  
Use this to check whether the machine body is in a level condition.

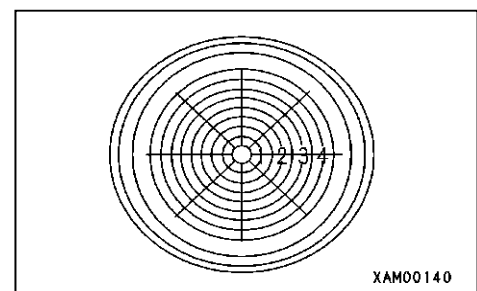

[15] WINCH 2 SPEED SELECTOR SWITCH

**⚠ WARNING**

- Perform raising and lowering operation at high speed only under a no load condition and without hoisting a load.  
Raising and lowering operation of a hoisted load at high speed may cause serious physical injury due to the machine tipping, breakage or dropping of a load.
- If the weight of a hoisted load is "0.5t" or more, the speed does not become high even when the winch 2 speed selector switch is operated.  
If the weight of a hoisted load is "0.2t" or less, it is possible to perform raising and lowering operation in high, but such operation may cause serious physical injury due to machine tipping, breakage or dropping of a load. Therefore, avoid such operation as much as possible.

Use this switch when changing the speed at the time of raising and lowering operation of the winch.

The lever switch can change the speed between "1st speed" and "2nd speed".

- High speed (2nd speed): Raising and lowering speed is increased.
- Low speed (1st speed): The speed returns to the normal raising and lowering speed.

Check that when the lever switch is pressed, the monitor display also changes.

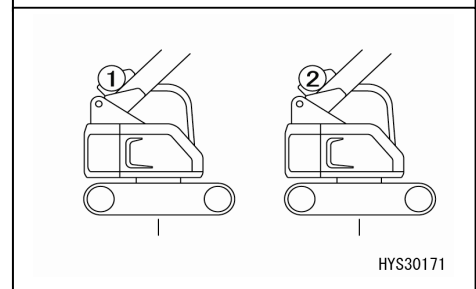
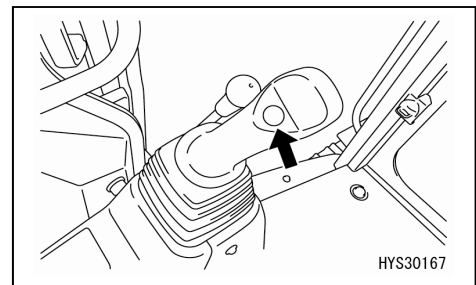

**NOTES**

When the number of wire falls of the moment limiter is set to "one fall", the speed does not become high even if this switch is placed in the "High speed (2nd speed)" position. The speed is fixed to "Low speed (1st speed)".

**[16] DISCONNECT SWITCH**

**CAUTION**

Be sure to place this switch in the "ON" position. Use this switch temporarily only in the case of preventing unexpected startup of electrical equipment during inspection and maintenance.

Use this switch to turn off the battery power supply to prevent unexpected startup of electrical equipment during inspection and maintenance.

- OFF: The battery power supply is turned off and no electricity flows through all the electrical systems.
- ON: The battery power supply is connected.

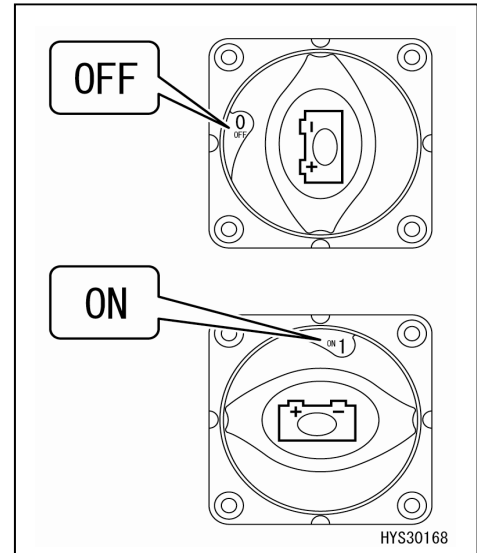

**[17] OVERRIDE SWITCH**

**⚠ DANGER**

Override switch has a function to disable the moment limiter.

When this switch is turned ON, the crane does not automatically stop with the moment limiter and is very dangerous. Any crane operation in such conditions may result in dropping of hoisted load, breakage of crane boom, and/or machine tipping, and may cause a serious accident resulting in death or serious injury.

Use this switch only when the moment limiter, which detects the crane conditions, fails or a load test of the crane is conducted. Key for the switch must be detached during normal operations.

In particular, never perform the following uses.

- Never wind up the hook when hoisting loads.  
Even if the weight of hoisted load exceeds the rated total load, the moment limiter cannot detect it, and could result in dropping of the hoisted load, boom breakage or machine tipping due to cutting of the winch wire rope.
- After the moment limiter detects that the rated total load is exceeded during crane operation and automatically stops the operation, do not perform hoisting operation, boom lowering operation and boom extension operation while the operation stop function is cancelled by turning this switch to the "ON" position. Such operation may cause boom breakage and machine tipping.
- Use the hook storage switch when storing the hook. If this switch is turned ON to perform hook hoisting operation, automatic stop is not made in an over winding condition.



Use this switch only when the moment limiter fails or a load test of the crane is conducted.

- ON: Insert the key into the switch. Turn the key clockwise and then return it to the original position. The key automatically returns to the "OFF" position when you release your hand.  
The operation stop function is cancelled for 10 minutes after it is turned ON.
- OFF: The key can be removed or inserted at this position.

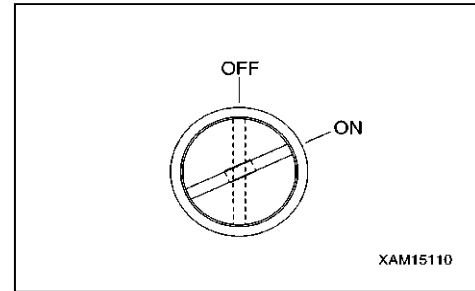

### NOTES

You will notice the following when the operation stop function is cancelled.

- The red lamp of the rotating warning lamp turns on.
- The LED of the switch box lights up.
- The buzzer sounds continuously.
- The icon will be displayed on the monitor.

[Overriding / Turn stater key off to reset]

The above statuses will change as follows 30 seconds before the operation stop function returns from the cancelled state.

- The LED of the switch box blinks.
- The buzzer additionally emits intermittent sound.
- Another icon will be displayed additionally on the monitor.

[Stop operation / Overriding soon stops]

However, these behaviors are subject to change depending on the status of the Machine body.

Although the boom lowering and extending operations slow down when the operation stop function is cancelled, this is normal.

By turning the engine key OFF, the Machine can be restarted even before 10 minutes have passed.

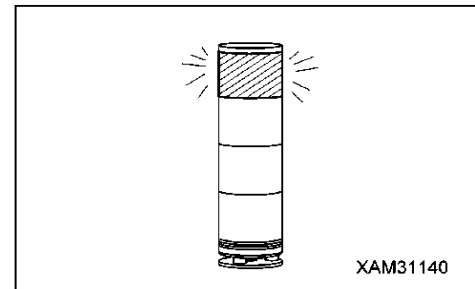

## 2.3 OPERATION LEVERS AND PEDALS

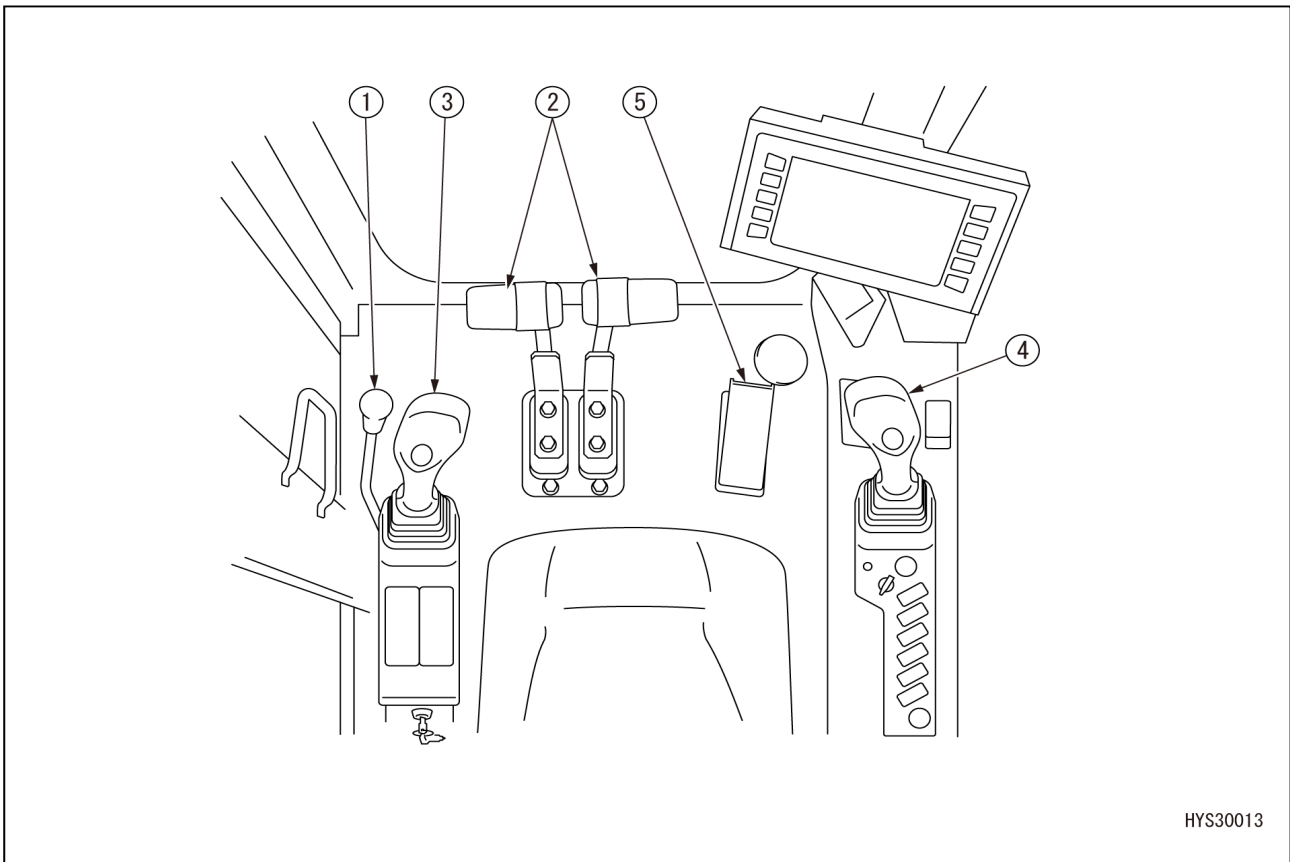

HYS30013

- |  |   |
|--|---|
| <p>(1) Lock lever</p> <p>(2) Travel lever (with auto deceleration mechanism)</p> <p>(3) Left work equipment operation lever (with auto deceleration mechanism)</p> | <p>(4) Right work equipment operation lever (with auto deceleration mechanism)</p> <p>(5) Accelerator pedal</p> |
|--|---|

### [1] LOCK LEVER

#### **⚠ WARNING**

- When standing up from the driver seat, place the lock lever securely in the lock position (L). If the lock lever is in the free position (F) and contacts the operation levers and operation pedals carelessly, serious physical injury may be caused.
- When you leave the driver seat or work is suspended, check that the lock lever is securely in the lock position (L).
- When pulling up or pushing down the lock lever, be careful not to allow it to contact the operation lever of work equipment.



Use this lever to lock crane operation, slewing and travel operation.

- (L) Lock: Pull up the lever. The machine does not move even if each operation lever is operated.
- (F) Free: Push down the lever. The machine moves if each operation lever is operated.

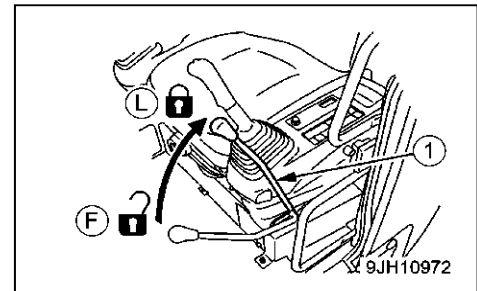

### NOTES

Because the machine is hydraulically locked by the lock lever, operation levers move even if the lever is placed in the lock position. However, the machine does not move.

### [2] TRAVEL LEVER

#### **! WARNING**

- When the sprocket (A) side is in the rear, the track frame faces forward. When the track frame faces rearward, the direction of travel lever operation is opposite to the direction of machine movement (forward and rearward movement, right and left movement direction).

**When operating the travel lever, be sure to check if the track frame faces forward or rearward.**

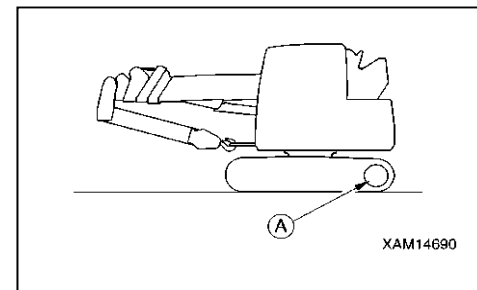

Use this lever to move the machine forward/rearward, stop, change the direction, and adjust the travelling speed.

- (a) Forward movement: Push the lever forward.
- (b) Rearward movement: Pull the lever toward you.
- (N) Neutral: Release your hand from the lever.

### NOTES

When the travel lever is operated to the forward or rearward direction from neutral, the alarm sounds and notifies the surrounding area that the machine will start moving.

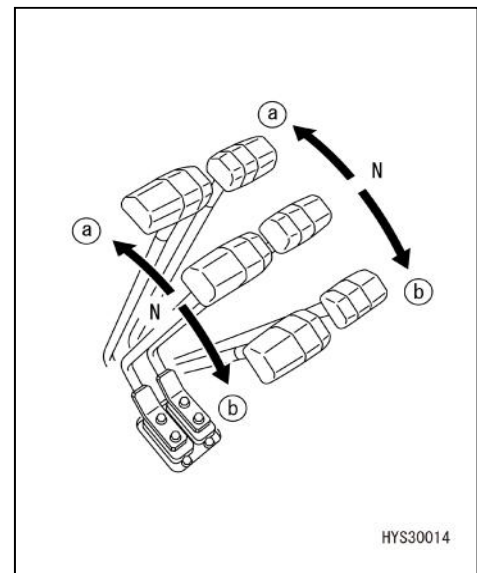

### [3] WORK EQUIPMENT OPERATION LEVER

#### ⚠ WARNING

- The operation pattern is set according to the standard operation method (ISO pattern). If you desire to change the operation pattern, please request us or our sales service agency.
- When the operation pattern is changed, the operation nameplate needs to be replaced with one that matches the machine movement.

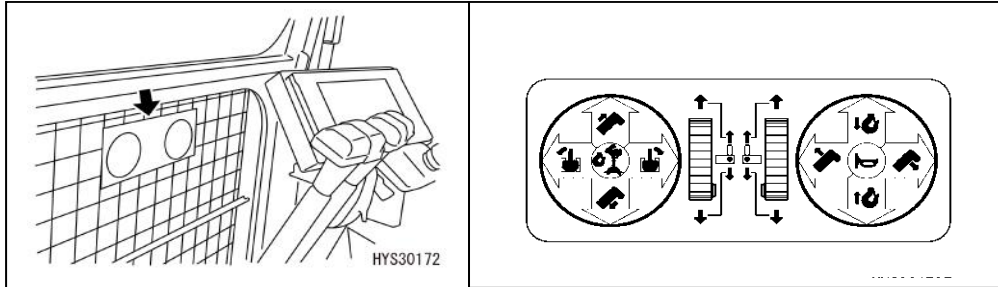

#### (1) Left work equipment operation lever

Use this lever to perform slewing operation of the revolving super structure and extension and retraction operation of the boom.

Slewing operation

- (a) Right slewing: Pull the lever in the right direction.
- (b) Left slewing: Push the lever in the left direction.

Extension and retraction operation of boom

- (c) Retraction of boom: Pull the lever rearward.
- (d) Extension of boom: Push the lever forward.

(N) Neutral: Release your hand from the lever.

The revolving upper structure and boom length retain their positions as they stop.

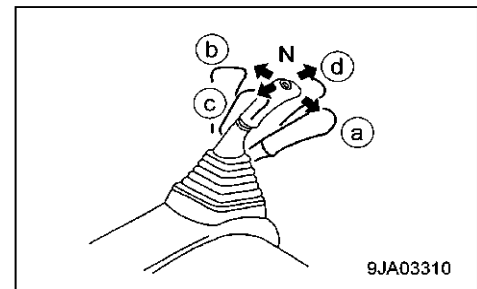

#### (2) Right work equipment operation lever

Use this lever to perform winch operation and boom derricking operation.

Winch operation

- (e) Hoisting: Pull the lever rearward.
- (f) Lowering: Push the lever forward.

Boom derricking operation

- (g) Lowering of boom: Push the lever in the right direction.
- (h) Raising of boom: Pull the lever in the left direction.

(N) Neutral: Release your hand from the lever.

The hook block and boom angle retain their positions as they stop.

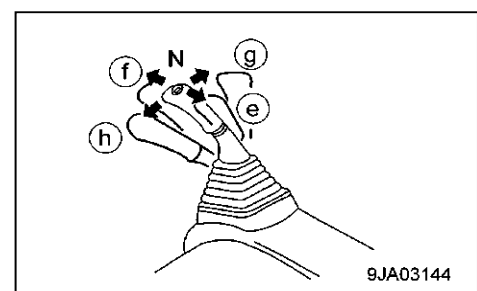



**[4] ACCELERATOR PEDAL**

**⚠ WARNING**

Use the accelerator pedal only when the machine stops and you operate the crane.  
 Never use this pedal during travel operation. An operation mistake may be made, resulting in serious physical injury.  
 Use the fuel adjustment dial to adjust engine speed during travel operation.

Use this lever to adjust the engine speed or output during crane operation.

- (a) Low idling: Release your foot from the pedal.
- (b) Full revolution: Depress the pedal fully.

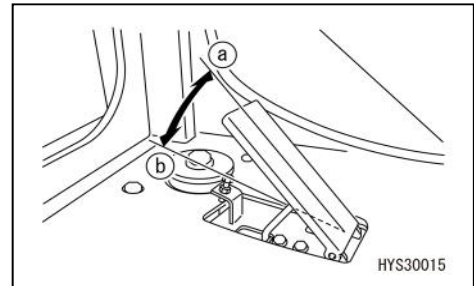

**NOTES**

As a priority is given to the engine speed of the fuel adjustment dial, the engine speed does not fall below the set speed of the fuel adjustment dial even if you release your foot from the accelerator pedal.

When performing work using the accelerator pedal, operate the fuel adjustment dial in advance to set the necessary minimum engine speed.

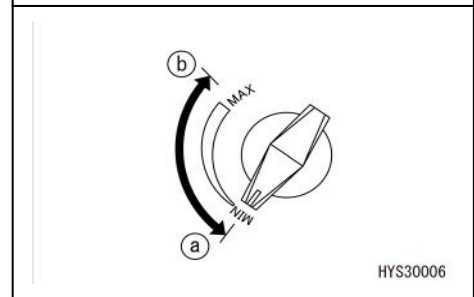

## 2.4 MOMENT LIMITER (OVERLOAD PREVENTIVE DEVICE)

### 2.4.1 CONFIGURATION OF MOMENT LIMITER

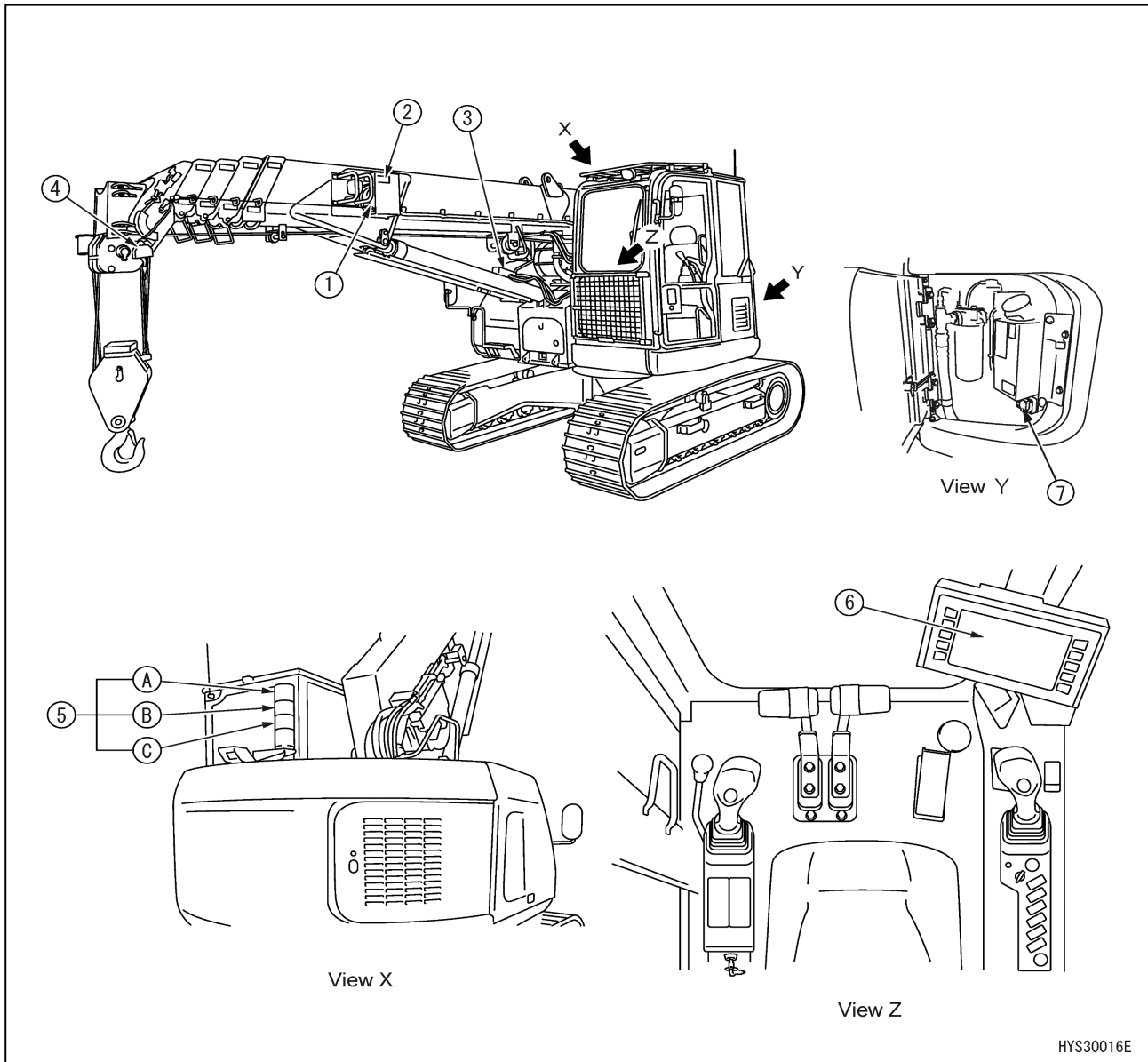

- (1) Boom length meter (left side of boom)
- (2) Boom angle meter (left side of boom)
- (3) Pressure sensor (derricking cylinder section) (2 pieces)
- (4) Overwinding detector (side of boom tip)
- (5) Rotating warning lamp
  - (A) Rotating red lamp (warning lamp when load factor is 100% or more)
  - (B) Rotating yellow lamp (prediction lamp when load factor is 90 - less than 100%)
  - (C) Rotating green lamp (operation lamp when load factor is less than 90%)
- (6) Machine monitor (moment limiter display section) (inside cab)
- (7) Override switch



## 2.4.2 FUNCTIONS OF MOMENT LIMITER

### **⚠ DANGER**

- Do not remove, disassemble, or repair the detector. In addition, do not reposition the detector from the original location to another.
- When an object hits the detector or damage is found on it, be sure to check the operating condition of the automatic stop.  
If any abnormality is found in the operation condition of automatic stop, be sure to repair it.
- The slewing operation does not stop automatically when the crane is overloaded. When overloaded, do not perform slewing operation.
- When the crane is approximating the stop position during boom operation, be sure to lower the boom operation speed.  
If the boom is at a high operation speed, it may exceed the predetermined stop position and the machine may tip over causing severe personal injury, which could lead to death or serious injury.

The moment limiter is a device that is installed to prevent dropping of the suspended load or breakage or tipping of the machine, which may occur due to overload.

Before starting crane operations, be sure to inspect operation of the moment limiter to make sure that there is no abnormality.

### [1] MECHANISM OF MOMENT LIMITER

The moment limiter knows the current posture by the boom angle meter and boom length meter and calculates "Rated total load" in the current condition by further knowing the number of wire falls (input by a driver).

When the load is hoisted actually at this time, the moment limiter calculates the "actual load" (hoisted load) according to the pressure value from the pressure sensor of the derricking cylinder section. The moment limiter makes comparison and calculation on "Rated total load" and "Actual load" (hoisted load) that were calculated in the current figure. Then, it issues an alarm if the result is as follows: "Actual load / Rated total load = 90 to 100%".

If the calculation result is "Actual load / Rated total load = 100% or more", the moment limiter issues an alarm and at the same time automatically stops the boom operation.

The overload stop accuracy satisfies the stop accuracy of the following formula by slowly lowering the boom.

$$\text{Stop accuracy} = \frac{A - B}{B} \times 100 < +10\%$$

Where, A: Total weight of suspended load + hook + hoisting attachment (Slings etc)

B: Rated total load of working radius (actually measured radius) where the boom stopped due to overload

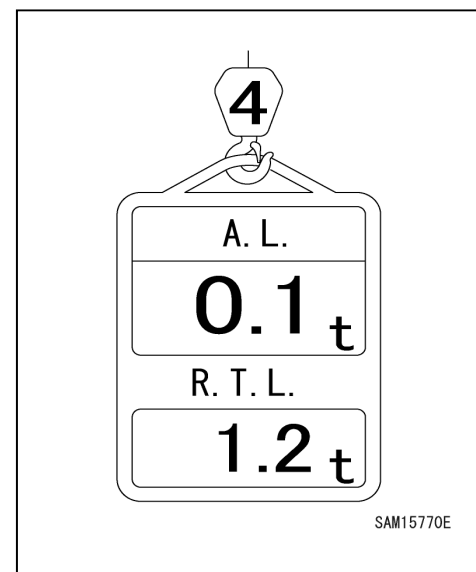

**[2] MOMENT LIMITER ABNORMALITY OCCURRENCE MESSAGE DISPLAY**

The moment limiter displays a fault code on the top screen of the monitor to notify the driver if an abnormality occurs in the boom angle meter, boom length meter or pressure sensor, or if wiring is cut or connectors come off.

If a moment limiter related fault code is displayed on the monitor, immediately stop the use of the crane.

For the fault code and cause and action for the abnormality, see "OPERATION 2.1.2 [2] LIST OF ERROR CODES".

**2.4.3 MOMENT LIMITER OPERATION AND CANCELING (RECOVERY)**

The moment limiter is a device that is provided for measures available for an emergency case. In actuality, any operations relying on the device will incur danger.

Operate the crane carefully so that it does not stop automatically.

**[1] PROHIBITED OPERATIONS AFTER AUTOMATIC STOP**

**⚠ DANGER**

The following crane operation is prohibited after the crane stops automatically due to overload.

Disobeying this rule may cause critical danger due to tipping of the machine or breakage of the boom, for example.

- Boom lowering operation • Boom hoisting operation • Boom extending operation
- Hook hoisting operation

**[2] RECOVERY OPERATION FROM AUTOMATIC STOP**

**⚠ DANGER**

If an automatic stop occurs, you will not be able to clear the stop until you have reduced the load factor to the safety area with a load factor of less than 90% (rotating warning lamp: green).

If the moment limiter displays the load factor of 90% or more, be sure to perform crane operations carefully by turning the engine speed to low.

Performing crane operations at a high engine speed could cause critical danger; in this case, the hoisted load will wobble resulting in overload, which could lead to tipping of the machine or breakage of the crane, for example.

**1. When load factor is "less than 90%"**

When the hoisted load is less than 90% of the rated total load, the green color of the rotating warning lamp which shows a normal use condition turns on.

**2. When load factor is "90% - less than 100%"**

When the hoisted load is 90% (prediction alarm) of the rated total load, the rotating warning lamp changes from the green color to the yellow color and the alarm sounds to notify the driver and persons in the surrounding area that the hoisted load approaches the rated total load.

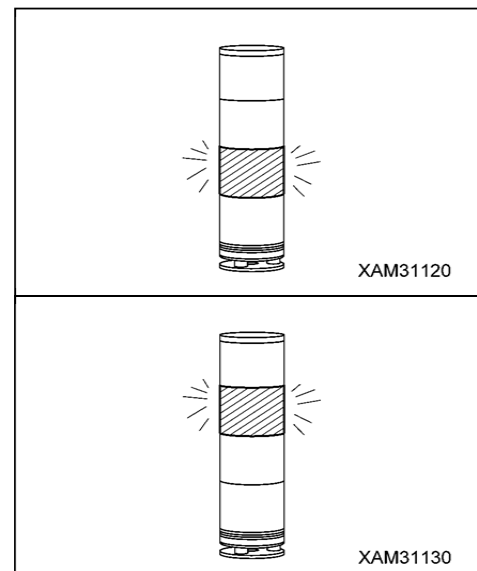

### 3. When load factor is "100% or more"

If the hoisted load exceeds 90% (prediction alarm) of the rated total load and the hoisted load becomes 100% or more of the rated total load by further continuing crane operations, the rotating warning lamp changes from the yellow color to the red color, the alarm sounds continuously and subsequent crane action stops automatically.

- Hook hoisting action • Boom extending action
- Boom lowering action • Boom hoisting action

In addition, audible warning "Peep, overload" is issued.

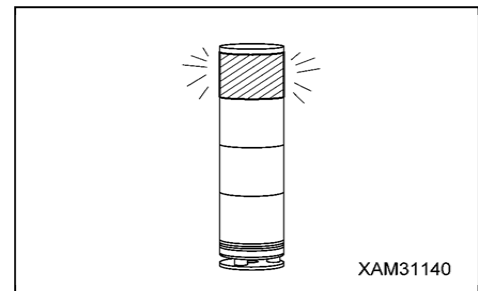

### 4. RECOVERY OPERATION FROM AUTOMATIC STOP

To perform recovery operation from overload, perform either of the following operations so that the crane action will be opposite to the one when the crane stopped automatically.

Note that the automatic stop cannot be cleared unless the load factor has first been lowered to the safety area with a load factor of less than 90% (rotating warning lamp: green).

(1) Perform hook lowering operation to put down the hoisted load.

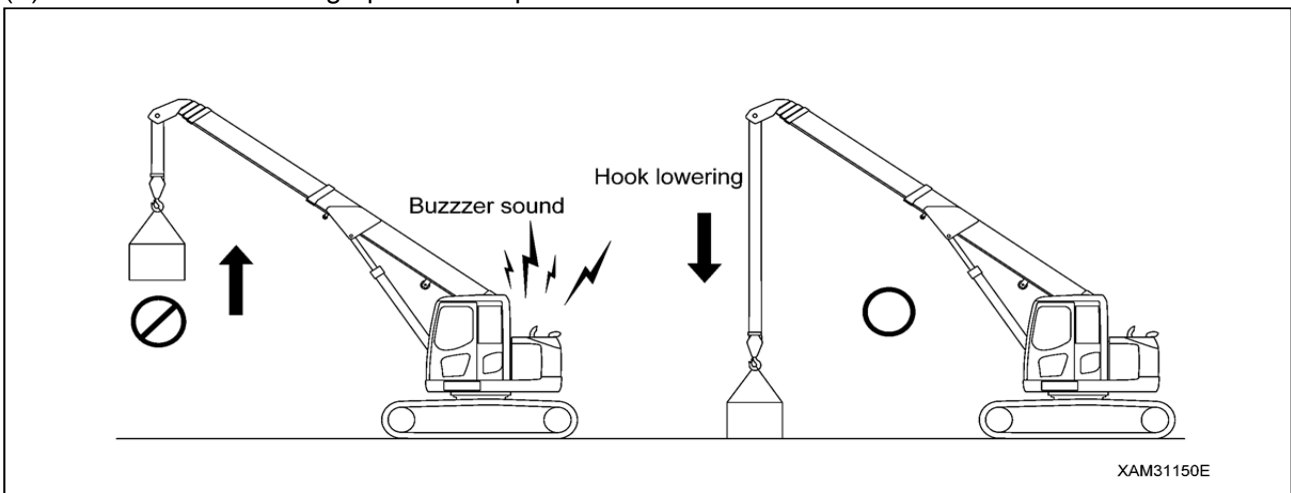

(2) Perform boom retraction operation.

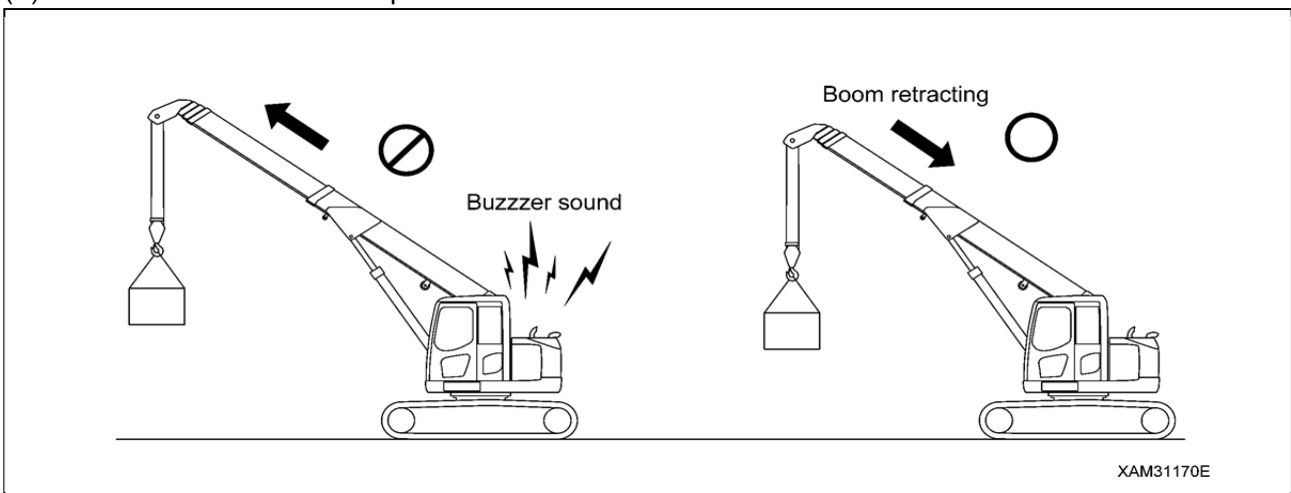



**[When recovering by boom hoisting operation]**

In the case of an automatic stop, when hoisting of the boom is unavoidable, the boom hoist operation is possible only while keeping the maintenance switch in the “ON” position. To return to the “OFF” position, also return the boom hoisting lever.

**⚠ DANGER**

**Only use this switch when an automatic stop has occurred through entry into the overload region while lowering or extending the boom.**

**Do not use under normal conditions or when lifting clear from the ground.**

**If you use this switch when lifting from the ground,**

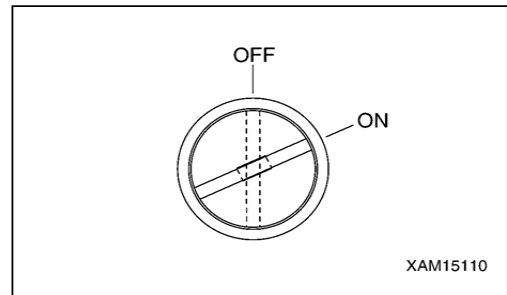

**NOTES**

While the maintenance switch is “ON”, the machine operates as follows.

- The engine speed decreases.
- The continuous buzzer tone sounds.
- The tri-colour revolving working status lamp illuminates in red.

## 2.4.4 MOMENT LIMITER FUNCTIONS

### [1] MONITOR DISPLAY OF MOMENT LIMITER

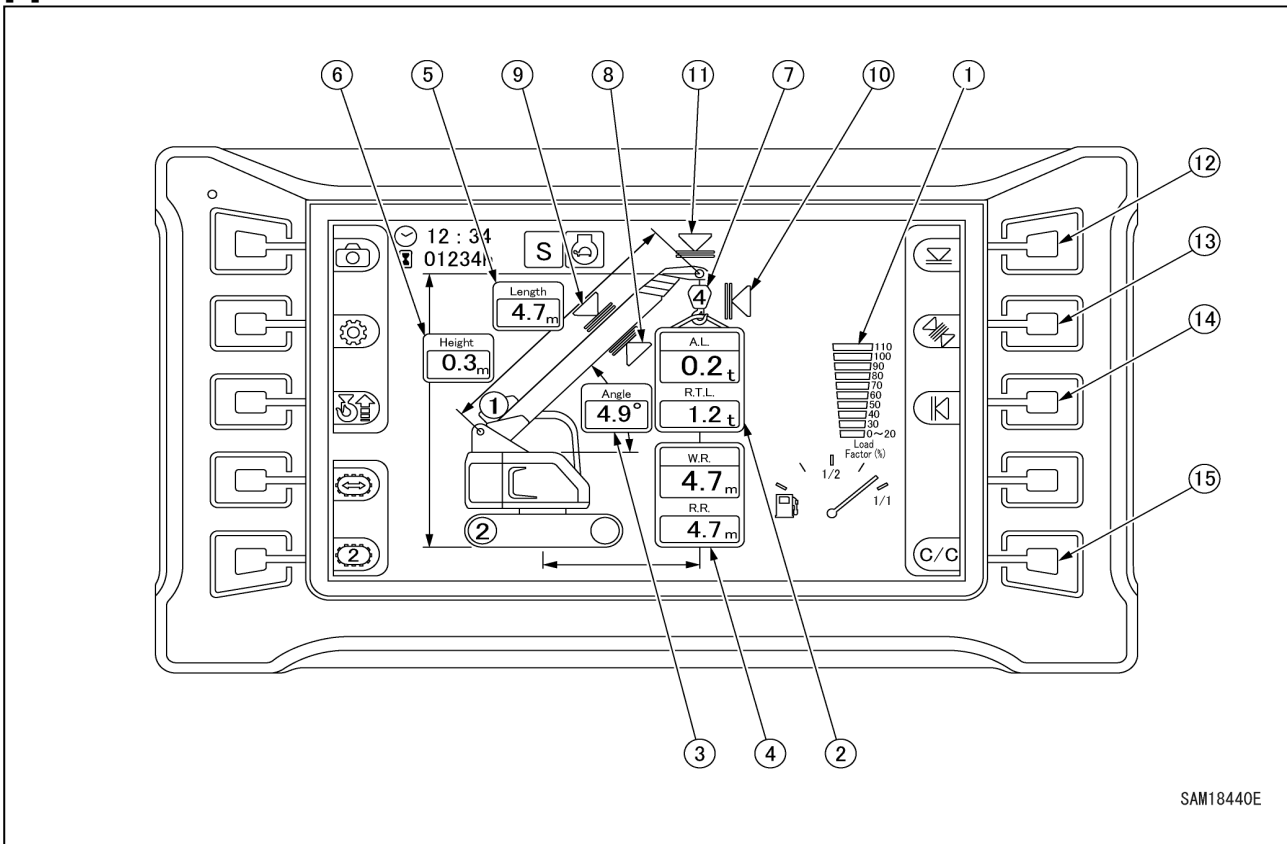

- |  |  |
|--|--|
| (1) Load factor display                                  | (8) Boom angle lower limit display             |
| (2) Actual load display/Rated total load display         | (9) Boom angle upper limit display             |
| (3) Boom angle display                                   | (10) Working radius upper limit display        |
| (4) Actual work radius display/rated work radius display | (11) Lifting height upper limit display        |
| (5) Boom length display                                  | (12) Lifting height upper limit switch         |
| (6) Lifting height display                               | (13) Boom angle upper limit/lower limit switch |
| (7) Number of wire falls display                         | (14) Working radius upper limit switch         |
|  | (15) Setting check/canceling switch            |





**[2] EXPLANATION OF MOMENT LIMITER DISPLAY**

**1. Rated total load display**

Continually displays the actual load of the hoisted load during crane operations.

The actual load equals the total weight of the hook, hoisting attachment, and hoisted load. When no load is hoisted, it is normal that "0.0" to "0.1" is displayed. Contact us or our sales service agency if outside this range.

<b>NOTES</b>
<ul style="list-style-type: none"> <li>• Due to the structure of load detection, a numerical value of actual load display changes when the boom is raised and lowered. Although the numerical value of the actual load changes on a higher side when boom raising operation is performed, this is not a fault.</li> <li>• When the crane stops, the numerical value of actual load display changes if there is swing of load.</li> </ul>

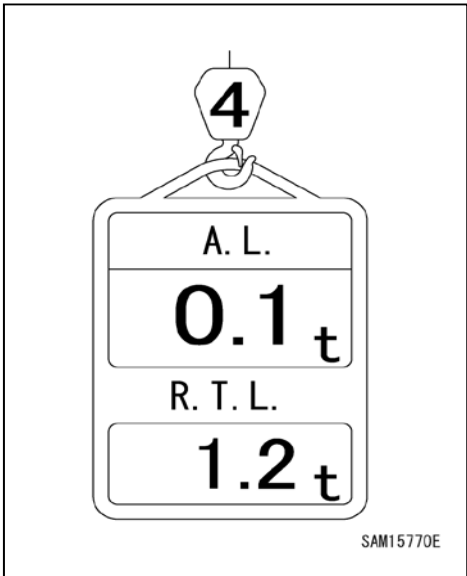

**2. Rated total load display**

The rated total load (i.e. total weight of hook, hoisting attachment, and hoisted load) which the crane can currently hoist is displayed. It is calculated according to the conditions including the number of wire falls of the hook and the working radius.

**3. Actual working radius display**

The current actual working radius is continually displayed during crane operations.

The actual working radius refers to the horizontal distance from the center of slewing of the crane to the center of the hook. The deflection amount of the boom due to load is not included.

**4. Rated working radius display**

The current rated working radius is continually displayed during crane operations.

The rated working radius refers to the maximum working radius calculated from the boom length and actual load.

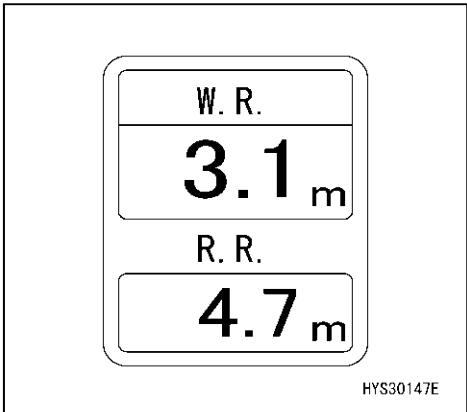

**5. Boom length display**

The current boom length is continually displayed during crane operations.

The boom length refers to the distance from the base pin of the boom to the sheave pin of the tip boom.

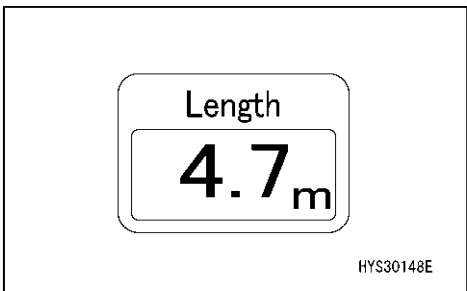

### 6. Lifting height display

The current lifting height is continually displayed during crane operations.

Lifting height refers to the vertical distance from the ground to the bottom of the hook.

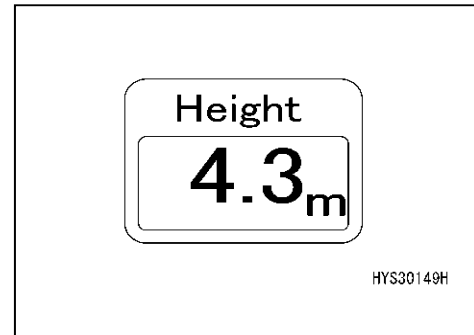

### 7. Boom angle display

The current boom angle is continually displayed during crane operations.

The boom angle refers to the angle between the boom and horizontal line.

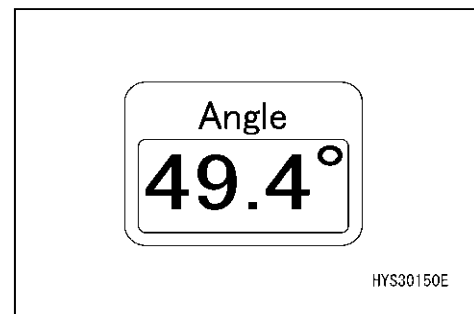

### 8. Overwinding display

If the hook falls into an overwinding state during crane operations, the mark flashes in red to give overwinding warning and automatically stops hook hoisting and boom extension actions.

During hook storage operation, the mark flashes in red in a hook stored state. However, this is not an abnormality.

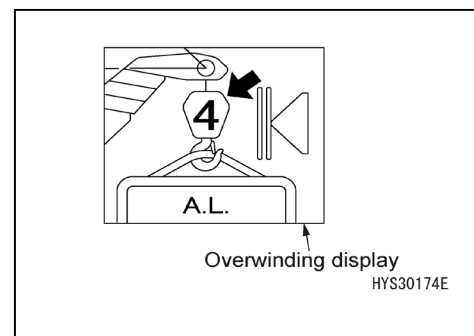

### 9. Overlowering display

If the hook falls into an overlowering state during crane operations, the mark flashes in red to give overlowering warning and automatically stops the hook lowering action.

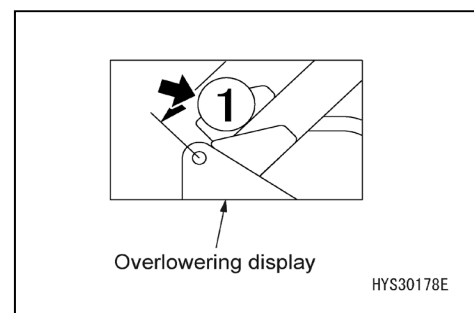

### 10. Load factor display

The load factor state of the moment limiter load is illuminated on the bar according to the load factor change.

- Load factor display 100 - 110 (Load factor 100% or more): red
- Load factor display 90 (Load factor 90 - less than 100%): yellow
- Load factor display 0 - 80 (Load factor less than 90%): green

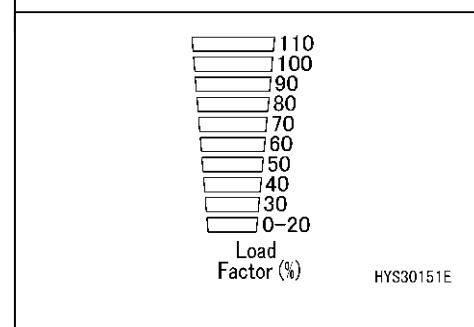



**[3] OVERLOAD ALARM**

A. Safety area ("Actual Load" is less than 90% of "Rated Total Load")

- The green color of the rotating warning lamp turns on.

B. Prediction alarm ("Actual Load" is 90 - less than 100% of "Rated Total Load")

- The yellow color of the rotating warning lamp turns on.
- The alarm generates intermittent sound "peep".

C. Limit alarm ("Actual Load" is greater than or equal to 100% of "Rated Total Load")

- The red color of the rotating warning lamp turns on.
- The alarm generates continuous sound "peep".
- Operation of the boom's danger side stops automatically.
- When the load factor is 110% or more, "Load factor 110%" LED (red) turns on.

D. Canceling of limit alarm automatic stop

When an automatic stop occurs, immediately recover from the overload.

For recovery operations, see "OPERATIONS 2.4.3 [2] RECOVERY OPERATION FROM AUTOMATIC STOP".

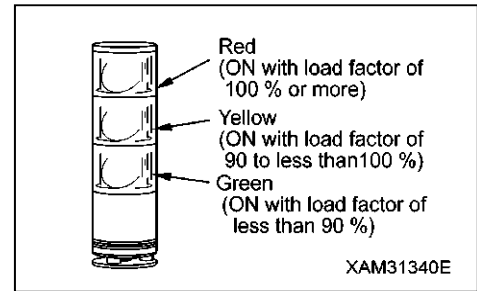

**[4] WORKING RANGE LIMIT DEVICE**

When the set value of the working range limit is neared, an alarm is issued to notify the driver and persons in the surrounding area.

For the set value of the working range limit, the last state is memorized when the starter switch is turned to the "OFF" position.

When the working range is set:

A. Safety area

- The applicable working range limit display illuminates in orange.
- The green color of the rotating warning lamp turns on.

B. Prediction alarm

- The applicable working range limit display flashes in orange.
- The announcement is given and the alarm generates intermittent sound "peep".  
The alarm buzzer is activated only when the operation lever operated.
- The green color of the rotating warning lamp turns on.

C. Limit alarm

- The applicable working range limit display flashes in orange.
- The yellow color of the rotating warning lamp turns on.

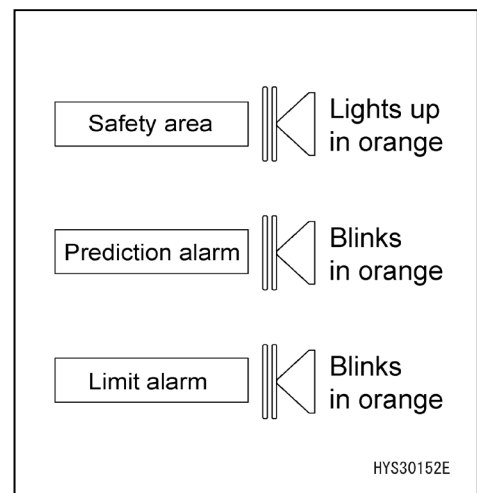



- The announcement is given and the alarm generates continuous sound "peep".  
The alarm buzzer is activated only when the operation lever operated.
- Operation of the boom's danger side stops automatically.

### 1. Lifting height upper limit switch

Use this switch to set or cancel the upper limit value of lifting height.

While the lifting height limit is imposed by detecting the boom tip height, the display panel displays the lifting height when the hook is hoisted up to the over winding detected state.

#### [Setting]

Set the boom to the desired lifting height in a condition in which no upper limit value is set, and press and hold the switch.

The monitor display changes to the orange color and the lifting height is set as the upper limit value.

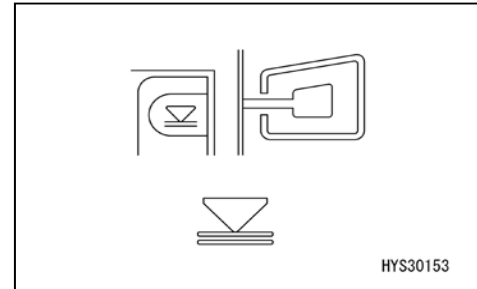

### NOTES

- Be sure to check, before actual work, that the boom automatically stops at the set lifting height. If the boom does not automatically stop, reset the lifting height in the above steps.
- When the boom is in the prediction alarm zone or upper limit stop state, an alarm sounds intermittently only if lowering operation or extension operation is performed.
- The set value is memorized when the starter switch is turned to the "OFF" position.

When the boom is in the prediction zone or upper limit stop state in a condition in which the lifting height is set, the monitor display illuminates in orange.

#### [Cancel]

Press and hold the switch in a condition in which the upper limit value is set. The monitor display changes to the black color and the upper limit value setting is canceled.

### 2. Boom angle upper limit/lower limit switch

Use this switch to set or cancel the boom angle upper limit value and lower limit value.

#### [Setting]

Set the boom to the desired angle in a condition in which no upper limit value and lower limit value are set, and press the switch. The green display appears and the upper limit and lower limit can be selected. Each time the switch is pressed, the upper limit and lower limit change. After selecting the one you wish to set, press and hold the switch.

The upper limit value on the monitor display changes to the orange color and the boom angle is set as the upper limit value or lower limit value.

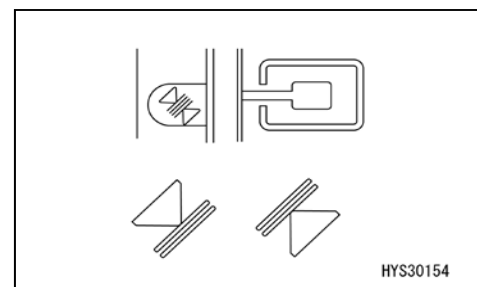



### NOTES

- Be sure to check, before actual work, that the boom automatically stops at the set angle. If the boom does not automatically stop, reset the boom angle in the above steps.
- An alarm sounds intermittently when the boom, which is in the upper limit, is in the prediction zone or upper limit stop state and only if the raising operation is performed, and when the boom, which is in the lower limit, is in the prediction zone or lower limit stop state and only if the lowering operation is performed.
- The set value is memorized when the starter switch is turned to the "OFF" position.

When the boom is in the prediction zone or upper limit stop state in a condition in which the boom angle upper limit or lower limit is set, the monitor display illuminates in orange.

#### [Cancel]

Press the switch in a condition in which the upper limit value or lower limit value is set. The orange display section can be selected in white frame. Each time the switch is pressed, the selection changes. After selection, press and hold the switch. The monitor display changes to the black color and the upper limit value or lower limit value setting is canceled.

### 3. Working radius upper limit switch

Use this switch to set or cancel the upper limit value of the working radius.

#### [Setting]

Set the boom to the desired working radius in a condition in which no upper limit value is set, and press and hold the switch.

The upper limit value on the monitor display changes to the orange color and the working radius is set as the upper limit value.

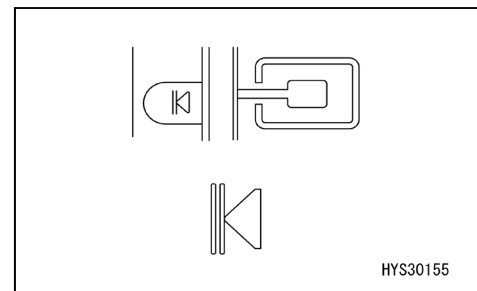

### NOTES

- Be sure to check, before actual work, that the boom automatically stops at the set working radius. If the boom does not automatically stop, reset the working radius in the above steps.
- When the boom is in the prediction alarm zone or upper limit stop state, an alarm sounds intermittently only if lowering operation or extension operation is performed.
- The set value is memorized when the starter switch is turned to the "OFF" position.

When the boom is in the prediction zone or upper limit stop state in a condition in which the working radius upper limit is set, the monitor display illuminates in orange.

#### [Cancel]

Press and hold the switch in a condition in which the upper limit value is set. The monitor display changes to the black color and the upper limit value or lower limit value setting is canceled.

### 4. Setting check/canceling switch

#### (1) Setting check

Use this switch to check all the set values set in the above sections 1 - 3.

- Press this switch.

All the set values set in the above sections 1 - 3 are displayed for about 5 seconds.

The boom angle upper limit is displayed in the boom length.

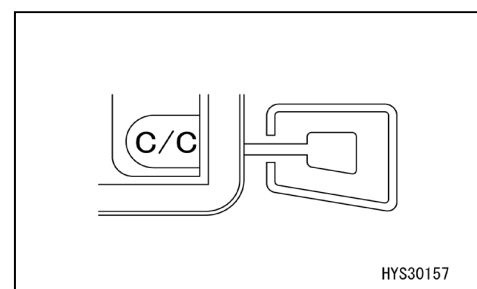



(2) Setting cancel

Use this switch to cancel all the set values set in the above sections 1 - 3.

- Press and hold this switch.

All the set values set in the above sections 1 - 3 are canceled.

**[5] Over winding prevention device**

**CAUTION**

**When hoisting the hook, be careful of clearance between the hook and boom.**

**When the boom is extended, the hook is also hoisted.**

**Perform boom extension operation while always checking the hook height.**

If the hook is over wound when the hook is hoisted or the boom is extended:

- The hook displayed on the monitor flashes in red.
  - When hook hoisting or boom extension operation is performed, the alarm issues an intermittent sound "peep".
  - Hook hoisting and boom extension actions stop automatically.
- When an automatic stop occurs, immediately recover from the stop.

For recovery operation, perform hook lowering operation and boom retraction operation.

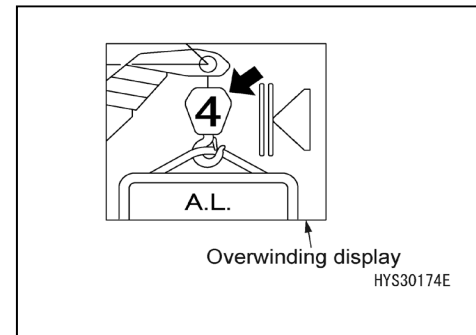

**[6] Overlowering prevention device**

When the hook is lowered and length of wire rope in the winch drum becomes short:

- The winch displayed on the monitor flashes in red.
- When hook lowering operation is performed, the alarm issues an intermittent sound "peep".
- The hook lowering action is automatically stopped.

When an automatic stop occurs, immediately recover from the stop.

For recovery operation, perform hook hoisting operation.

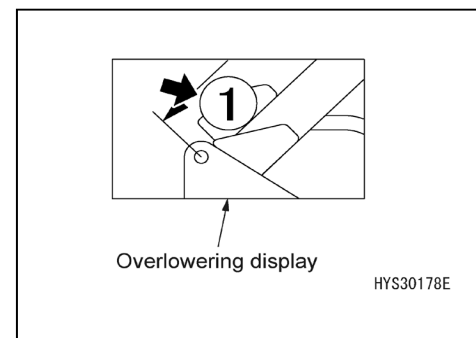

**[7] Number of wire falls change display**

**⚠ DANGER**

- Stop crane operations before changing the number of wire falls using the number of wire falls change switch.

**Changing the number of wire falls during crane operations may cause an unexpected accident.**

- Be sure to match the number of wire falls display of the moment limiter with the actual number of wire falls before performing crane operations. Otherwise, a serious accident may be caused.



For wire rope, safe load per rope fall is determined. Determine the number of falls according to the maximum hoisting load.

Be sure to match the actual number of wire falls of the hook with the number of wire falls displayed on the monitor.

This machine is equipped with a hook that serves for both 4 and 2 wire ropes as standard specifications.

For the set value of the number of wire falls, the last state is memorized when the starter switch is turned to the "OFF" position.

See "OPERATION 2.1.1 [2-3] HOOK SLING NUMBER CHANGE" for the change of the number of wire falls.

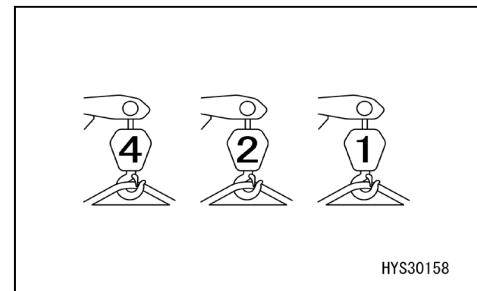

**[8] BOOM LOWER LIMIT DETECTION**

When the boom length is "5.3m" or longer, the boom lowering action stops automatically so that the boom does not fall below the horizontal line.

**[9] STATIONARY AND TRAVEL MODE CHANGE DISPLAY**

**⚠ DANGER**

**Travel with a lifted load is in principle not advisable because it is very unstable and involves danger.**

**If travel with a lifted load is unavoidably performed, see "OPERATION 3.24 OPERATION DURING TRAVELLING HOIST " and strictly observe the rated total load, operation method and travel posture with a lifted load at the time of travel with a lifted load.**

**Unless these precautions in traveling with a lifted load are observed, serious physical injury may be caused.**

When traveling with a lifted load, use this to change from the stationary mode to the travel mode.

- Press and hold the switch. The rated load setting changes to "Travel mode" and the monitor display changes.
- Press and hold this switch again. The rated load setting changes to "Stationary mode" and the monitor display changes.

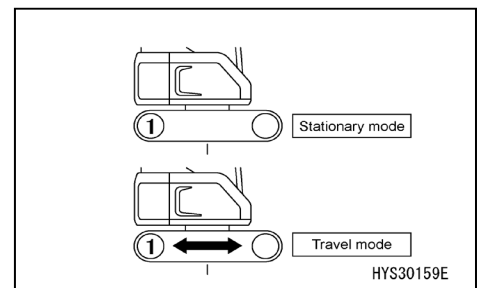

<b>NOTES</b>
<ul style="list-style-type: none"> <li>• When the boom length is "10.6m" or longer, travel is prohibited and the mode cannot be set to the travel mode. When setting the mode to the travel mode, make arrangements so that the boom length is "10.5m" (three stage boom) or less.</li> </ul>

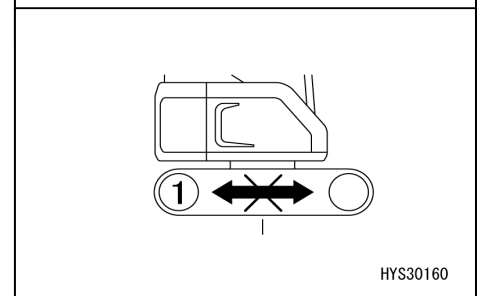



### 2.4.5 OVERRIDE SWITCH

#### **⚠ DANGER**

Override switch has a function to disable the moment limiter.

When this switch is turned ON, the crane does not automatically stop with the moment limiter and is very dangerous. Any crane operation in such conditions may result in dropping of hoisted load, breakage of crane boom, and/or machine tipping, and may cause a serious accident resulting in death or serious injury.

Use this switch only when the moment limiter, which detects the crane conditions, fails or a load test of the crane is conducted. Key for the switch must be detached during normal operations.

In particular, never perform the following uses.

- Never wind up the hook when hoisting loads.

Even if a load of hoisted load exceeds the rated total load, the moment limiter cannot detect it, resulting in a possible dropping of hoisted load, boom breakage and machine tipping due to cutting of the winch wire rope.

- After the moment limiter detects that the rated total load is exceeded during crane operation and automatically stops the operation, do not perform hoisting operation, boom lowering operation and boom extension operation while the operation stop function is cancelled by turning this switch to the "ON" position. Such operation may cause boom breakage and machine tipping.
- Use the hook storage switch when storing the hook. If this switch is turned ON to perform hook hoisting operation, automatic stop is not made in an overwinding condition.

Use this switch only when the moment limiter fails or a load test crane is conducted.

- ON: Insert the key into the switch. Turn the key clockwise and then return it to the original position. The key automatically returns to the "OFF" position when you release your hand.  
The operation stop function is cancelled for 3 minutes after it is turned ON.
- OFF: The key can be removed or inserted at this position.

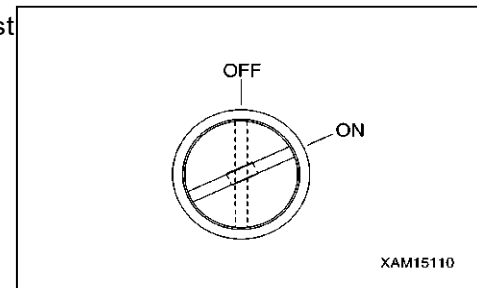



### NOTES

You will notice the following when the operation stop function is cancelled.

- The red lamp of the rotating warning lamp turns on.
- The LED of the switch box lights up.
- The buzzer sounds continuously.
- The icon will be displayed on the monitor.

[Overriding / Turn stater key off to reset]

However, these behaviors are subject to change depending on the status of the Machine body.

Although the boom lowering and extending operations slow down when the operation stop function is cancelled, this is normal.

By turning the engine key OFF, the Machine can be restarted even before 3 minutes have passed.

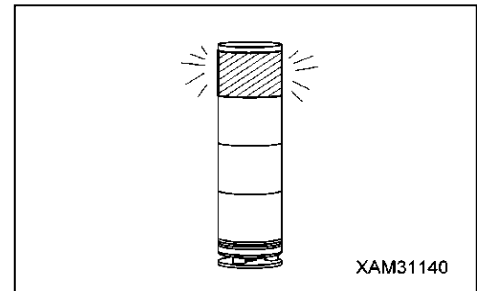

## 2.5 OVERWINDING PREVENTION DEVICE

### CAUTION

When raising the hook block, be careful of clearance between the hook block and boom. Also, the hook block can be raised when the boom is extended. Perform boom extension operation while always checking the hook block height.

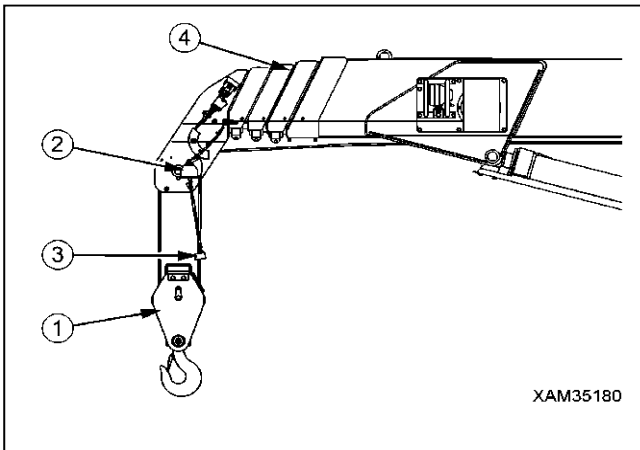

- (1) Hook block
- (2) Overwinding detector
- (3) Weight
- (4) Boom

The overwinding prevention device, when hoisting the hook block (1) or extending the boom (4), automatically stops hook block (1) hoisting and boom (4) extension actions and prevents any further action, if the hook block (1) nears the boom (4) tip and pushes up the weight (3). At the same time, only when the hook hoisting and boom extending operations are performed, the overwinding prevention device sounds the buzzer intermittently to warn overwinding.

When the warning buzzer sounds, immediately operate the right work equipment operation lever to the "Lowering" side (pushing forward) or the left work equipment operation lever to the "Retraction" side (pulling toward you) to lower the hook block (1).

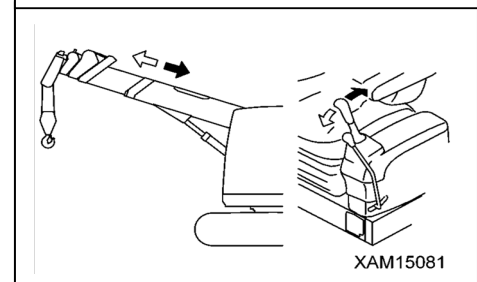
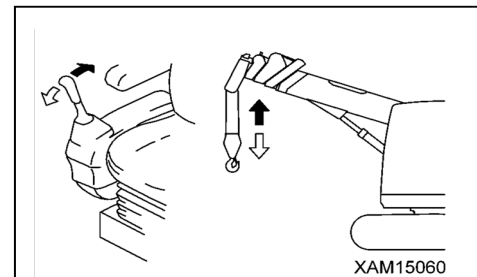

## 2.6 AIR CONDITIONER HANDLING

### 2.6.1 COMPONENTS OF CONTROL PANEL

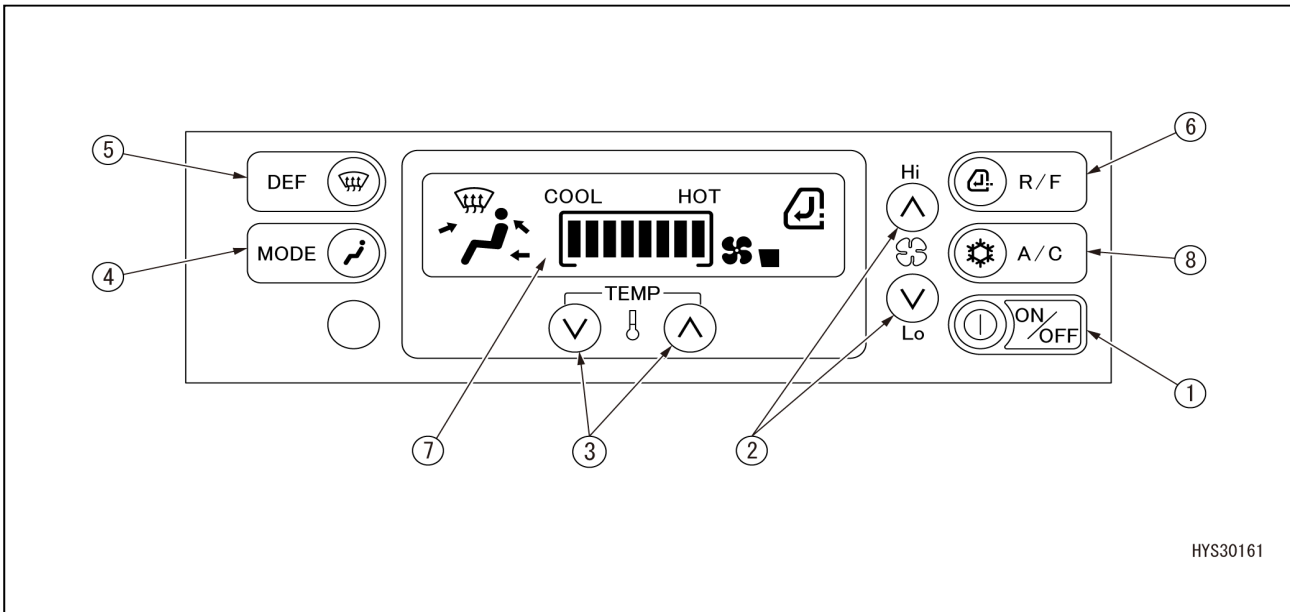

HYS30161

- |                                |   |
|--------------------------------|---|
| (1) ON/OFF switch              | (5) Defroster air flow switch                   |
| (2) Fan switch                 | (6) Fresh and recirculating air selector switch |
| (3) Temperature setting switch | (7) Display panel                               |
| (4) Air outlet selector switch | (8) A/C switch                                  |

#### [1] ON/OFF SWITCH

Use this switch to stop the operation of the fan and air conditioner.

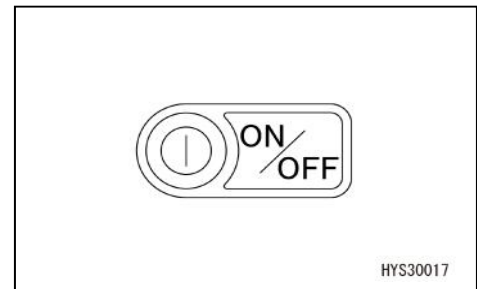

HYS30017



**[2] FAN SWITCH**

Use this switch to adjust the amount of air flow.

The amount of air flow can be adjusted in four stages.

- When the  $\wedge$  switch is pressed, the amount of air flow increases, and when the  $\vee$  switch is pressed, the amount of air flow decreases.

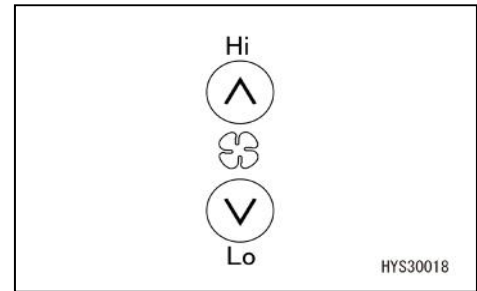

**[Monitor display and amount of air blow]**

Monitor display	Amount of air blow
	Air flow "Weak"
	Air flow "Medium 1"
	Air flow "Medium 2"
	Air flow "Strong"

**[3] TEMPERATURE SETTING SWITCH**

Use this switch to adjust the temperature in the cab.

- When the  $\wedge$  switch is pressed, the set temperature increases, and when the  $\vee$  switch is pressed, the set temperature decreases.

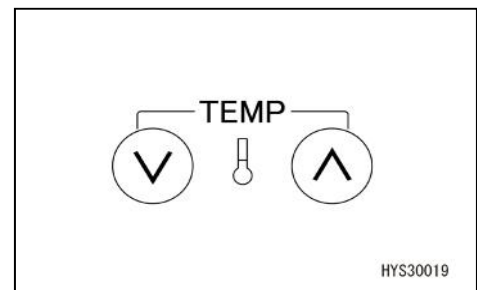

The interior temperature can be set to eight stages.

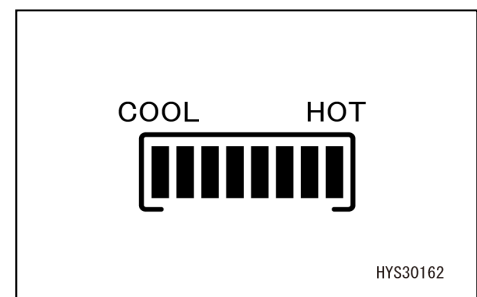

**[4] AIR OUTLET SELECTOR SWITCH**

Use this switch to change the air outlet.

- When the switch (4) is pressed, the air outlet is displayed on the panel display section (7).

Air outlet

- Air outlet (A): Rear air outlet (1 location)
- Air outlet (B): Front air outlet (2 locations)
- Air outlet (C): Foot air outlet (1 location)
- Air outlet (D): Front windshield air outlet (1 location)

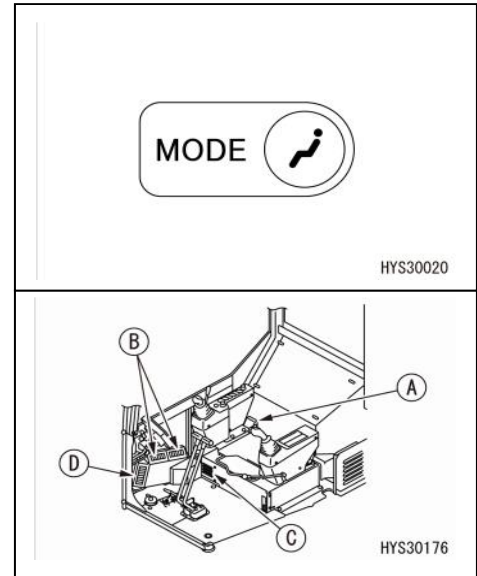

Liquid crystal display	Air flow mode	Air outlet			
		(A)	(B)	(C)	(D)
	Front air flow		○		
	Front and rear air flow	○	○		
	Front and rear foot air flow	○	○	○	
	Foot air flow			○	
	Foot air flow and defroster air flow			○	○

Note: Air is blown from air outlets with ○ mark.

**[5] DEFROSTER AIR FLOW SWITCH**

Use this switch to change the air outlet.

- When the switch (5) is pressed, the air outlet is displayed on the panel display section (7).

Air outlet

- Air outlet (D): Front windshield air outlet (1 location)

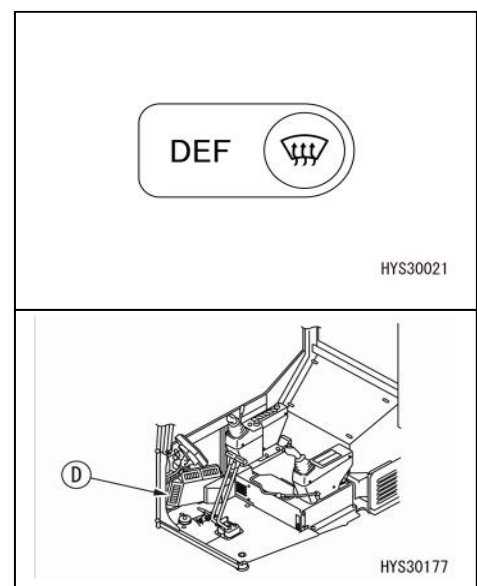



Liquid crystal display	Air flow mode	Air outlet			
		(A)	(B)	(C)	(D)
	Defroster air flow				○

Note: Air is blown from air outlets with ○ mark.

### [6] FRESH AND RECIRCULATING AIR SELECTOR SWITCH

Use this to change between interior air recirculation and fresh air intake.

Interior air recirculation	The fresh air is shut and the interior air is recirculated. Use this mode to quickly cool the interior or when the fresh air is dirty.
Fresh air intake	The fresh air is taken into the interior. Use this mode to take in the clean air or to remove fogging of the window glass.

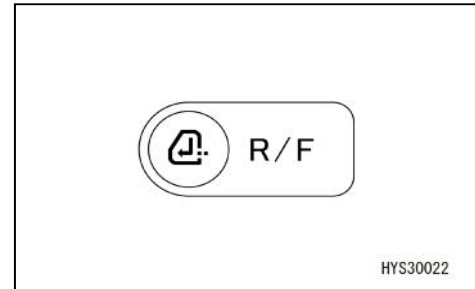

### [7] DISPLAY MONITOR

This display monitor (7) displays the state of the temperature setting (a), amount of air flow (b) and air outlets (c).

- When the OFF switch (1) is pressed, the display of temperature setting (a) and amount of air flow (b) disappears and the operation is stopped.

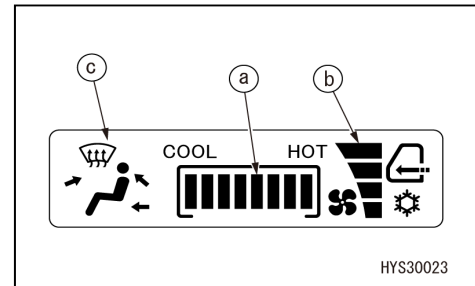

### [8] A/C SWITCH

Use this switch (8) to operate and stop the air conditioner (cooling, dehumidification and heating).

- When this switch (8) is pressed during fan operation (a state in which the amount of air flow (b) of the display monitor is displayed), the air conditioner turns "ON" and the air conditioner operates, which is displayed on the display monitor. When the switch is pressed again, the air conditioner turns "OFF" and stops.
- The air conditioner does not operate when the fan stops.

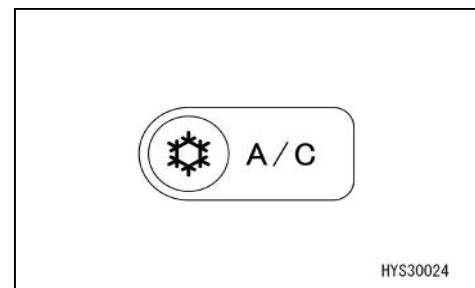





## 2.6.2 AIR CONDITIONER OPERATION METHOD

### [1] OPERATION

1. Press the fan switch (2) to adjust the amount of air flow.  
Check, at this time, that the set temperature and the amount of air flow are displayed on the display panel.

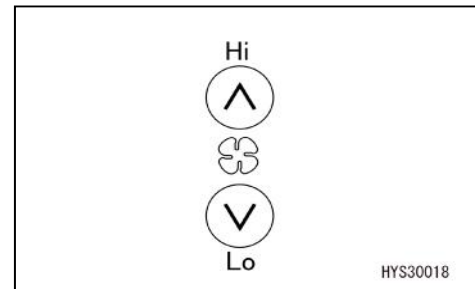

2. Press the air conditioner switch (8) to turn it to "ON".

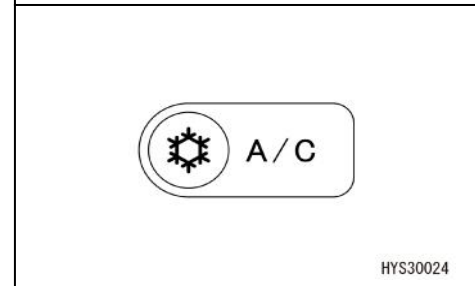

3. Press the temperature setting switch (3) to adjust the temperature to the desired one.

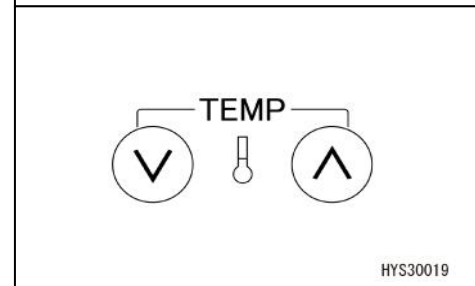

4. Press the air outlet selector switch (4) to select the desired air outlet.  
At this time, the display of the air outlet of the display panel changes according to the selection.

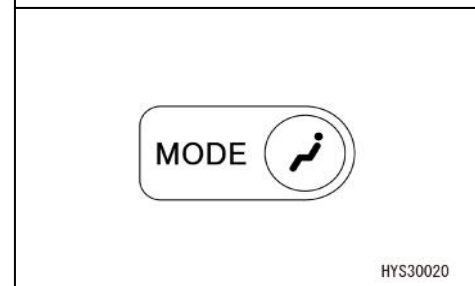

5. Press the fresh and recirculating air selector switch (6) to select either interior air recirculation or fresh air intake.

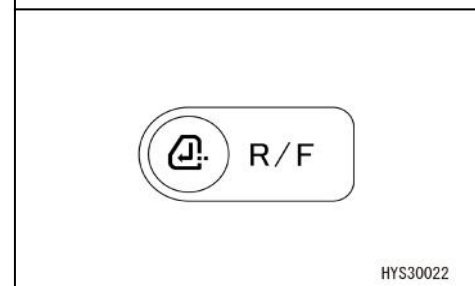

### [2] OPERATION STOP

Press the ON/OFF switch (1). The operation stops.

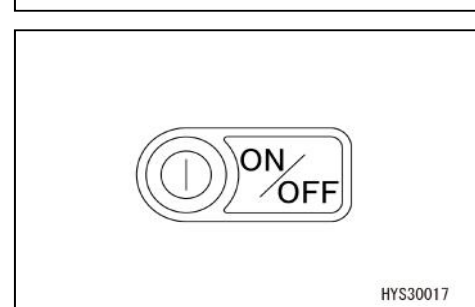

**[3] DEFROSTER OPERATION**

1. Press the fan switch (2) to adjust the amount of air flow.  
Check, at this time, that the set temperature and the amount of air flow are displayed on the display panel.
  
2. Press the defroster air flow switch (5) and check that the air outlet is the defroster on the display panel.
  
3. Press the fresh and recirculating air selector switch (6) to take in fresh air.
  
4. Press the temperature setting switch (3) to set the set temperature display of the display monitor to the maximum heating state.
  
5. Adjust the air outlet (D) so that the air flow blows against the windshield.

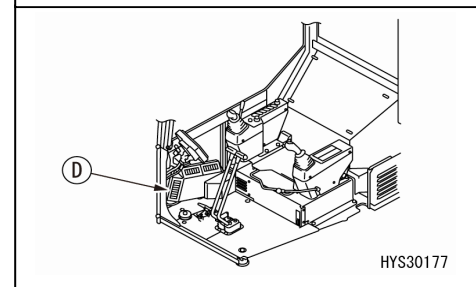
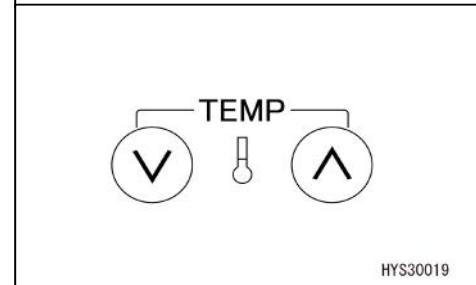
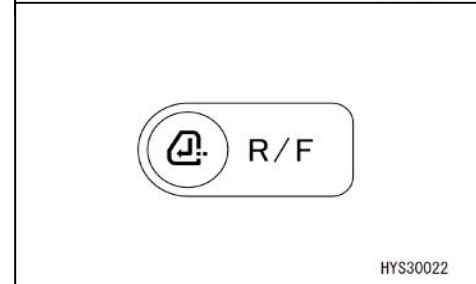
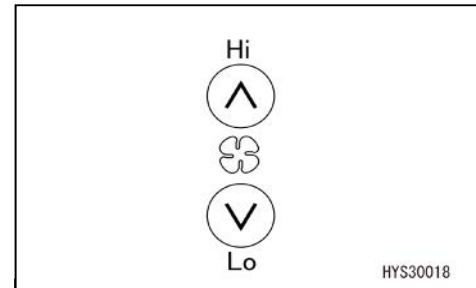

<b>NOTES</b>
When you want to remove window fogging or dehumidify in a rainy season, press the air conditioner switch (8) to turn it to "ON".

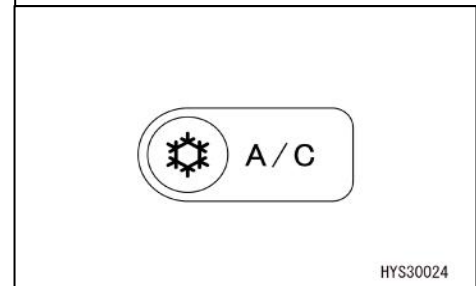



### 2.6.3 PRECAUTIONS IN AIR CONDITIONER USE

#### CAUTION

- **Be sure to start the engine at low speed when breaking in the air conditioner. Never start the air conditioner when the engine is running at high speed. Such may cause the air conditioner to malfunction.**
- **If water enters the control panel or sunlight sensor, an unexpected fault may be caused. Be careful not to allow water to be splashed onto the above. Be sure to keep away from flames.**
- **Always keep the sunlight sensor clean so that the auto function of the air conditioner is fully exhibited and at the same time do not put obstacles in the surrounding area of the sensor function.**

#### **[Provide ventilation sometimes during cooling.]**

- When you use the air conditioner for long hours, provide ventilation cooling once an hour.
- If you smoke a cigarette while providing cooling, you sometimes have sore eyes. In such a case, open the window temporarily to expel smoke.

#### **[Be careful of overcooling.]**

The cooling temperature is said to be optimal for the health if you feel a little cool (difference from outside temperature: 5 - 6°C) the moment you enter the cab. Pay due attention to temperature adjustment.

### 2.6.4 INSPECTION AND MAINTENANCE OF AIR CONDITIONER INSTALLED IN THE MACHINE

- When performing inspection and maintenance of an air conditioner installed machine, see the following and perform inspection and maintenance of respective items.
  - "INSPECTION AND MAINTENANCE 10.3 [8] CHECKING AND SERVICING AIR-CONDITONER"
  - "INSPECTION AND MAINTENANCE 10.5 [4] CHECKING/ADJUSTING AIR-COMPRESSOR BELT TENSION"
  - "INSPECTION AND MAINTENANCE 10.6 [5] CLEANING AIR-CONDITIONER OUTDOOR/INDOOR AIR FILTERS"
- When you do not make regular use of the air conditioner, occasionally perform cooling or dehumidification and heating operation for several minutes in an engine low speed condition so that oil in various parts of equipment does drain out.
- The air conditioner does not operate in some cases when the temperature in the interior is low. In this case, heat the cab by the interior air recirculation before turning on the air conditioner switch.

## 2.7 CAR RADIO HANDLING

### 2.7.1 EXPLANATION OF THE EQUIPMENT

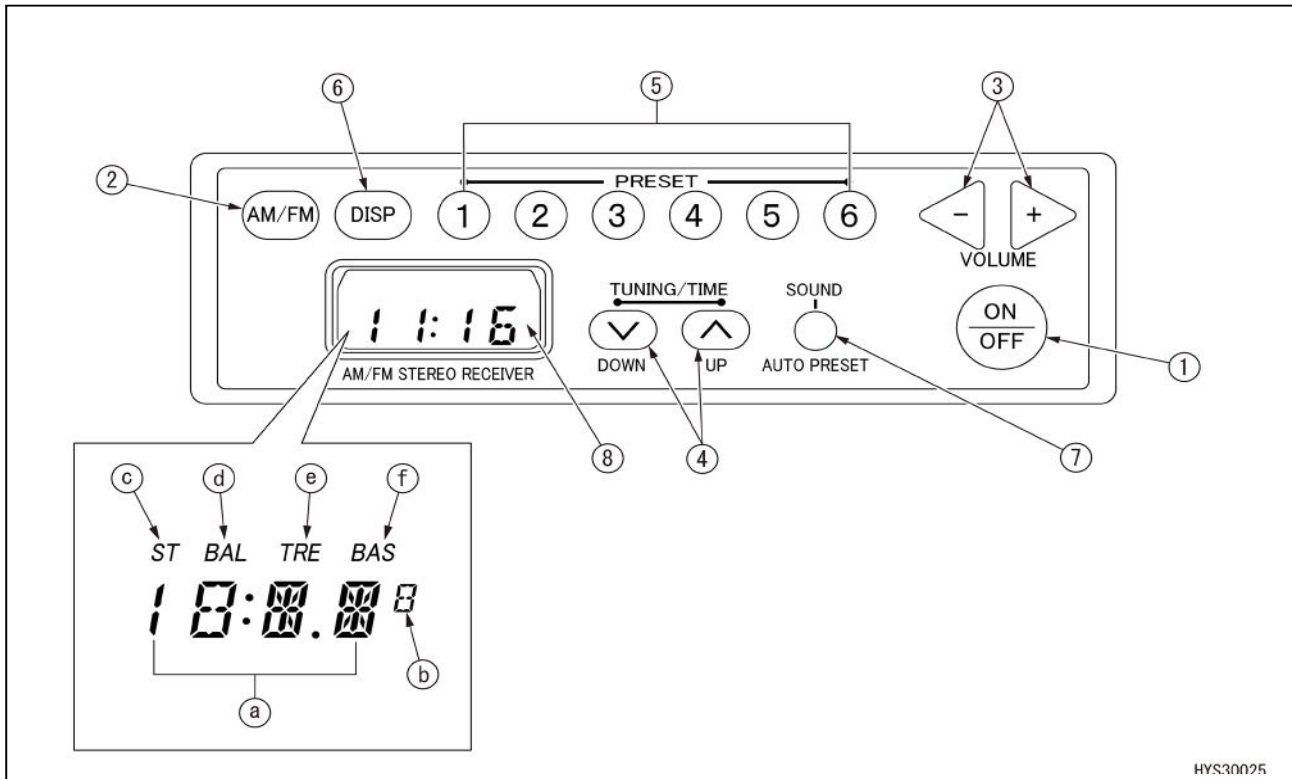

#### Main body section

- |                           |                                     |
|---------------------------|-------------------------------------|
| (1) Power button          | (5) Preset button                   |
| (2) AM/FM selector button | (6) Display selector button         |
| (3) Volume control button | (7) Sound quality adjustment button |
| (4) Tuning button         | (8) Display                         |

#### Display part

- |   |   |
|---|---|
| (a) Characters/numerical value information such as the band name, frequency and clock is displayed. | (d) This turns on at the time of balance adjustment with sound quality adjusted.    |
| (b) The frequency at the time of FM 50kHz step is displayed.  | (e) This turns on at the time of high sound adjustment with sound quality adjusted. |
| (c) This turns on at the time of stereo reception with FM1/FM2 selected.                            | (f) This turns on at the time of low sound adjustment with sound quality adjusted.  |



**[1] POWER BUTTON (ON/OFF)**

The radio power turns on and the frequency is displayed on the display (8).  
When the button is pressed again, the power turns off.

**[2] AM / FM SELECTOR BUTTON (AM/FM)**

The sound quality adjustment of the desired band can be set.  
Each time the button is pressed, the indication of the display (8) changes "FM→AM→FM...".

**[3] VOLUME CONTROL BUTTON (VOLUME)**

This control the volume.  
When "+" is pressed, the volume increases and when "-" is pressed, the volume decreases. The numerical value showing the degree of volume is displayed on the display (8).

**[4] TUNING BUTTON (TUNING/TIME)**

Use this button to change the frequency or to adjust the clock.  
See "OPERATION 2.7.2 Car radio operation method" for the tuning method.

**[5] PRESET BUTTON (PRESET) (1, 2, 3, 4, 5, 6)**

You can let buttons of 1 - 6 memorize the frequency of broadcasting stations and select the station with one touch.  
Six stations each of AM and FM can be memorized.  
See "OPERATION 2.7.2 CAR RADIO OPERATION METHOD" for the preset method.

<b>NOTES</b>
You can manually let the preset button (5) memorize the frequency.
Operate the volume control button (7) to let the buttons automatically memorize the frequency.

**[6] DISPLAY SELECTOR BUTTON (DISP)**

This button enables changing of the radio frequency display and time display.  
Furthermore, use this button to adjust the time.  
See "OPERATION 2.7.2 CAR RADIO OPERATION METHOD" for the time adjustment.

**[7] SOUND QUALITY ADJUSTMENT BUTTON (SOUND) (AUTOPRESET)**

Each time the button (2) is pressed, the display changes "BAL (c) (Balance) →TRE (d) (High sound) →BAS (e) (Low sound) ..." and sound quality adjustment of each mode can be set.  
Use this button to let the buttons automatically memorize the frequency.  
See "OPERATION 2.7.2 CAR RADIO OPERATION METHOD" for details of each mode.



**[8] DISPLAY**

This displays the reception band, frequency, preset number and time.

**[Antenna]**

Be sure to store the antenna to keep out of the way during transportation or when you take the machine in the garage. Take the following steps for storage.

1. Loosen the antenna mounting bolt (1) and store the antenna in the storage position (A).
2. After storing the antenna, tighten the mounting bolt (1).

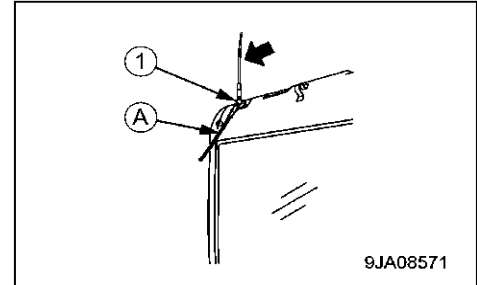

## 2.7.2 CAR RADIO OPERATION METHOD

### [1] TUNING METHOD

1. Press the power button (1). The frequency is displayed on the display (8).
2. Use the tuning button (4) to tune to the desired frequency.

Tuning has two types: Auto tuning and manual tuning.

#### • Manual tuning

Press the tuning button (4) until the frequency is displayed on the display (8).

∨ button: The frequency moves to the lower side.

∧ button: The frequency moves to the higher side.

When the frequency moves to the upper limit or lower limit, it automatically changes from the upper limit to the lower limit and from the lower limit to the upper limit.

#### • Auto tuning

Press the tuning button (4) for "3 seconds or longer". When a station is received, the frequency automatically stops.

Press the tuning button (4) for "3 seconds or longer". again to search the next station.

∨ button: A station with the lower frequency is automatically selected.

∧ button: A station with the higher frequency is automatically selected.

When this button is pressed again during auto tuning, auto tuning is canceled and the frequency before the button is pressed is received.

### [2] ADJUSTMENT METHOD OF PRESET BUTTON

1. Press the power button (1). The frequency is displayed on the display (8).
2. Use the tuning button (4) to tune to the desired frequency.
3. Continue to press the preset number (5) of the number to be memorized for "1.5 seconds or longer" with the desired frequency displayed on the display (8). Sound during reception disappears, but when the memory is completed, sound comes out again and at the same time the preset number and frequency are displayed on the display (8), notifying that the memory is completed.
4. After the memory completion, when the preset button (5) is pressed, the station memorized in that button can be received. One number of the preset buttons (5) can memorize one station of AM and FM, respectively.

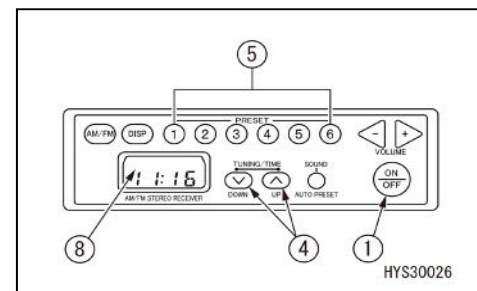





**[3] OPERATION METHOD OF EACH MODE**

To set each mode, operate the sound quality adjustment button (7) and tuning button (4).

1. Low sound (BAS) adjustment

Press the button (7) to display "BAS" on the display (8).

Operate the tuning button (4) to adjust low sound.

- ∨ button: Emphasize low sound
- ^ button: Attenuate low sound

2. High sound (TRE) adjustment

Press the button (7) to display "TRE" on the display (8).

Operate the tuning button (4) to adjust high sound.

- ∨ button: Emphasize high sound
- ^ button: Attenuate high sound

3. Balance (BAL) adjustment

Press the button (7) to display "BAL" on the display (8).

Operate the tuning button (4) to adjust the right and left balance of speakers.

- ∨ button: This selects the right speaker and emphasized its volume.
- ^ button: This selects the left speaker and emphasized its volume.

"BAL0" is a state in which the right and left are balanced. (Default value)

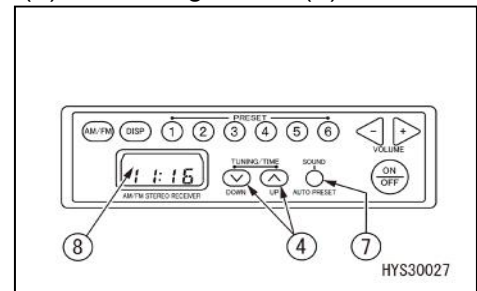

<b>NOTES</b>
In all modes, the display returns automatically to the original display after a lapse of 5 seconds.

**[4] ADJUSTMENT METHOD OF TIME**

Operate the display selector button (6) and tuning button (4) to set time.

1. Continue to press the display selector button (6) from the state in which the display (8) displays time for "1.5 seconds or longer". Time display flashes.

2. When you continue to press the display selector button (6) for "1.5 seconds or longer", the "hour" part of time display flashes.

Operate the tuning button (4) to adjust "hour".

- ^ button: Each time the button is pressed, time is advanced by one hour.
- ∨ button: Each time the button is pressed, time is put back by one hour.

(If you continue to press the button, you shift "hour" continuously.)

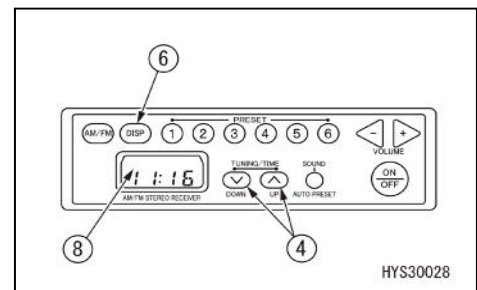



3. When the display selector button (6) is pressed, the "minute" part flashes.  
Operate the tuning button (4) to adjust "minute".
  - ∨ button: Each time the button is pressed, time is advanced by one minute.
  - ^ button: Each time the button is pressed, time is put back by one minute.  
(If you continue to press the button, you shift "minute" continuously.)
4. Press the display selector button (6) to terminate time adjustment.

### **2.7.3 PRECAUTIONS IN CAR RADIO USE**

- For your safety, use the volume control to the extent that you can hear sound outside the machine during operation.
- Listening at a high volume for long hours may cause hearing loss.
- If water enters the speaker case or car radio, an unexpected fault may be caused. Be careful not to allow water to be splashed onto the above.
- Do not wipe graduations and buttons with a solvent such as benzene and thinner. Wipe them with dry soft cloth (soak it in alcohol if heavily soiled).
- As all memories of the preset buttons are erased at the time of battery replacement, reset preset buttons.

## 2.8 FUSE

### ⚠ CAUTION

Be sure to turn the starter switch to the "OFF" position when checking or replacing a fuse.

### CAUTION

Fuses protect electrical components and wires from being burnt out.

- Fuses used here are blade fuses. If a fuse is corroded and shows white powder, be sure to change the fuse.
- If a fuse has melted, always check the cause in the circuit and fix the problem before changing the fuse.
- Always make sure the replacement fuse is of the same capacity.

The fuse holder is installed in the cover on the rear left of the cab.

#### [Fuse capacity and circuit name]

Systems and capacities of fuses are as follows:

No.	Capacity	Connection table
(1)	10A	Operation switch
(2)	5A	Operation switch
(3)	30A	Controller I/O power supply
(4)	5A	Controller K15, Monitor power supply
(5)	10A	Headlamps, Boom working lamp
(6)	10A	Option, Backup lamp, Yellow rotating lamp
(7)	10A	Horn
(8)	5A	A/C controller, Radio
(9)	15A	A/C power supply
(10)	10A	Accessory power supply
(11)	5A	PPC lock
(12)	10A	Front window wiper, washer
(13)	10A	Ceiling window wiper, washer
(14)	5A	Multilayer rotating lamp, Voice speaker
(15)	5A	Controller control power supply, Monitor control power supply
(16)	20A	Engine controller
(17)	5A	Interior lamp, Radio
(18)	20A	Key switch B
(19)	10A	Key switch ON Secondary side
(20)	10A	Key switch ST Secondary side

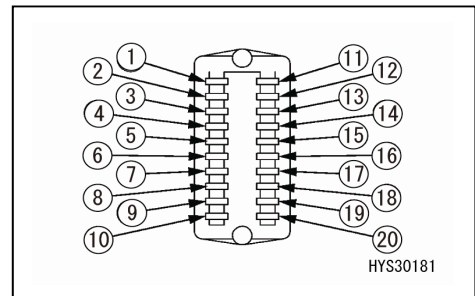
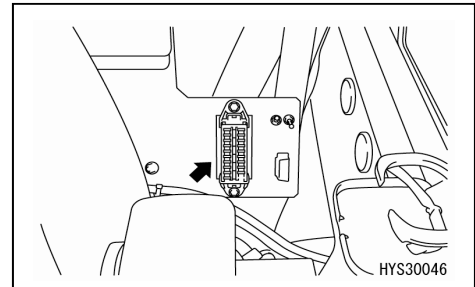

## 2.9 FUSIBLE LINK

### ⚠ CAUTION

Be sure to turn the starter switch to the "OFF" position when checking or replacing a fusible link.

### CAUTION

A fusible link refers to large fuse wiring installed in the circuit through which a large capacity current flows.

As with a normal fuse, this protects electrical equipment and wiring from burning due to abnormal current.

- If a fusible link has melted, always check the cause in the circuit and fix the problem before changing the fusible link.
- Always make sure the replacement fusible link is of the same capacity.

The fusible link is located on the left side in the battery room.

If the following phenomena occur, a fusible link is considered to be broken. Open the battery room and inspect and replace the fusible link.

- If the starter does not operate when the starter switch is turned to the "START" position, the fusible link (2) is considered to be broken.
- If it is difficult, when cold, to start the engine when the starter switch is turned to the "HEAT" position, the fusible link (1) is considered to be broken.

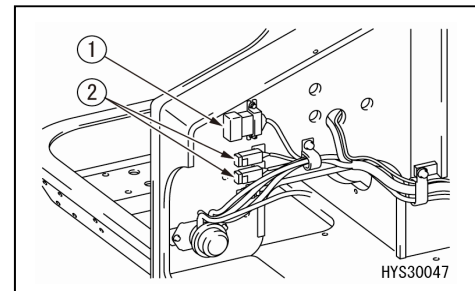

### [Fusible link capacity and circuit name]

Systems and capacities of fusible links are as follows:

No.	Connector No.	Capacity	Circuit name
(1)	FL1	120A	Mainly related to engine (glow, fuel pump)
	FL2	30A	Fuel pump
	FL3	60A	Glow
(2)	FL4	45A	Continuous power
	FL5	45A	Battery power (ACC)



## 2.10 CONTROLLER

### CAUTION

- Do not splash water, mud, juice and so on onto the controller. Doing so may cause a malfunction.
- If an abnormality occurs in the controller, do not repair it by yourself but contact us or our sales service agency for inspection and repair.

#### [1] MACHINE CONTROLLER AND MOMENT LIMITER CONTROLLER

The controllers are installed in the cover on the rear of the cab.

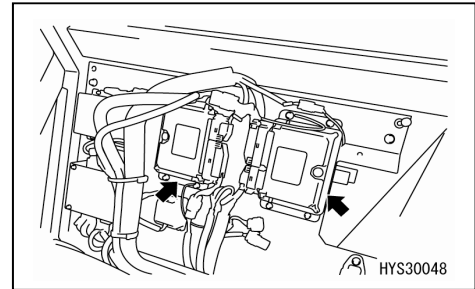

#### [2] ENGINE CONTROLLER

The engine controller is installed on the upper left in the engine compartment.

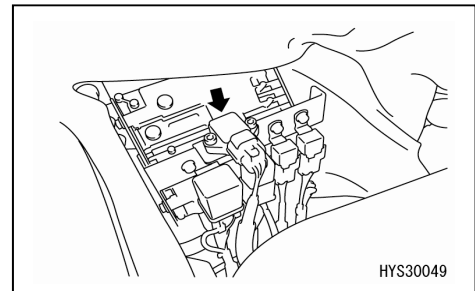

## 2.11 CAB FRONT WINDOW

### ⚠ WARNING

- When standing up from the driver seat, place the lock lever securely in the lock position. If the lock lever is in the free position and contacts the operation levers and operation pedals carelessly, serious physical injury may be caused.
- Open and close the front window at a level place after stopping the engine.
- When opening the front window, hold the handle securely with both hands and pull it up. Do not release your hands until it is locked in the automatic lock catch.
- When closing the front window, hold the handle securely with both hands to close.

- The upper side front window can be stored in the interior ceiling (pull-up).

### [1] WHEN OPENING

1. Stop the machine on a level place and stop the engine.
2. Place the lock lever (1) securely in the lock position (L).

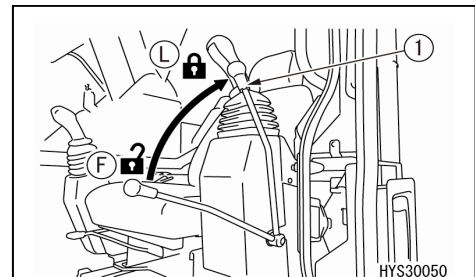

3. While holding the handle (A) (two locations) on the right and left of the front window, push down the lever (B) (two locations) with the thumb and disengage the lock of the upper part of the front window. The upper part of the front window comes off.

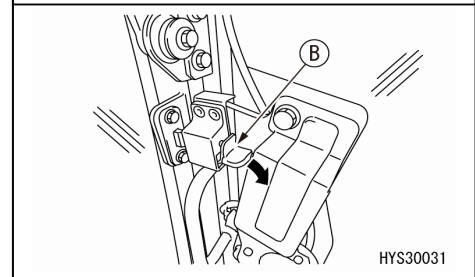
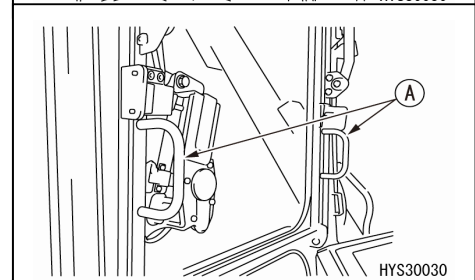

4. Hold and pull up the right and left handles (A) from the cab inside and securely push them against the lock (C) in the rear of the cab until "click" sound is heard to lock.

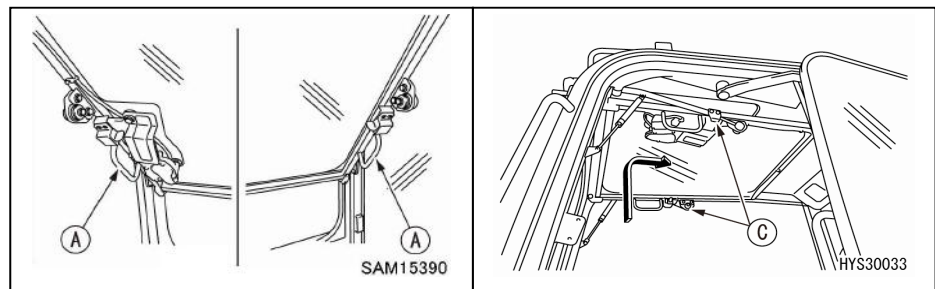

5. Check that the lever (B) is securely in a locked state.

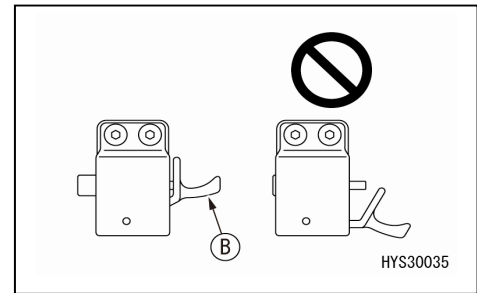

**[2] WHEN CLOSING**

**⚠ WARNING**

**When closing the front window, slowly lower it to prevent your hand from being pinched.**

1. Stop the machine on a level place and stop the engine.
2. Place the lock lever (1) securely in the lock position (L).

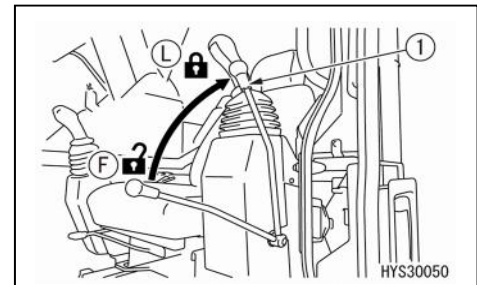

3. While holding the right and left handles (A), pull the lever (B) downward to disengage the lock.

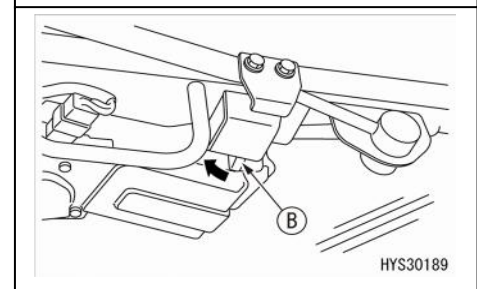
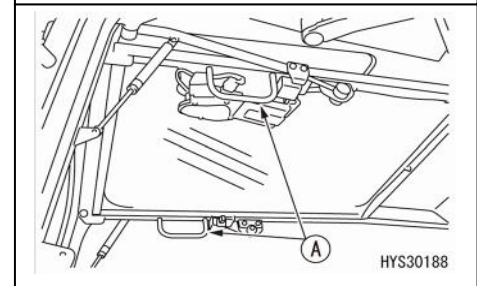



4. Hold the handles (A) of the front window with both hands, push them forward and gently lower them.

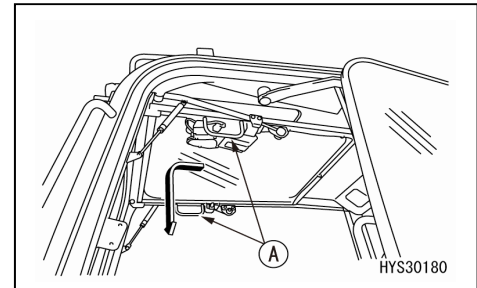

5. After moving the front window to the sash to align the position, push it forward and securely push it against the right and left locks (E) until "click" sound is heard to lock.

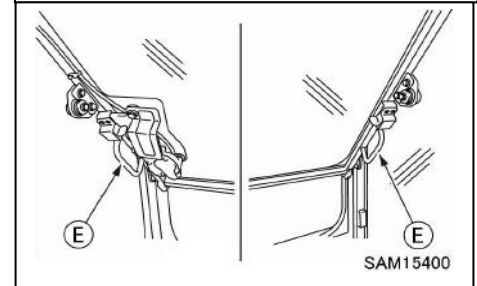

6. Check that the lever (B) is securely in a locked state.

## 2.12 DOOR

### **! CAUTION**

- Check that the door is always in a locked state when it is opened and closed before use.
- Be sure to open and close the door on a level place. If it is opened and closed on a slope, operating force may change suddenly, which is dangerous.
- Be sure to hold the door handle (1) when performing opening and closing operation of the door.
- Be careful not to allow your hand to be pinched by the front pillar or center pillar.
- When there is someone in the cab, call him/her before opening or closing the door.

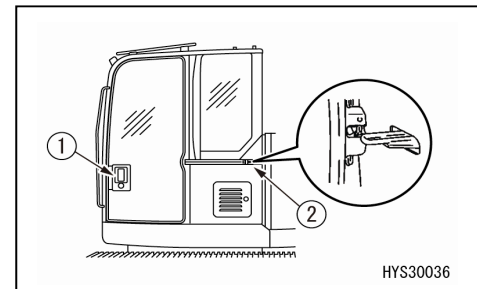

### **[Door lock]**

To close the door, pull the door handle (1) backward once and disengage the lock (2) before closing the door.

When opening and closing the door, move until the door is locked.

When opening and closing the door from the cab interior, operate the lock canceling lever (4) downward and disengage the door lock before operating the door.

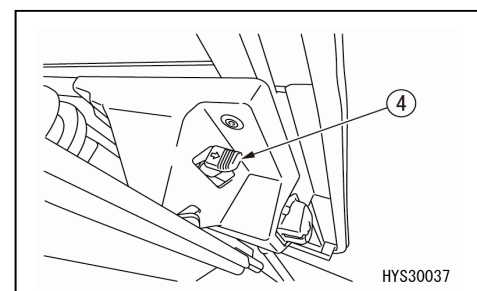

## 2.13 HAMMER FOR EMERGENCY ESCAPE

### CAUTION

- When striking the window glass with a hammer, be careful not to be injured by pieces of scattered broken glass.
  - When escaping, remove pieces of the glass from the sash to avoid injury by pieces of the glass.
- Pay also due attention so that you will not slip on pieces of the broken glass.**

A hammer (1) is provided in the left rear pillar for escaping from the driver cabin in case of emergency if the cab door does not open.

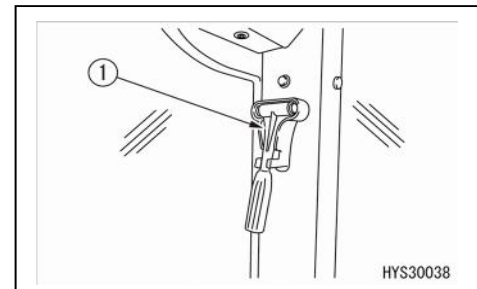

To escape, strike and break the window glass with the hammer (A) for escape.

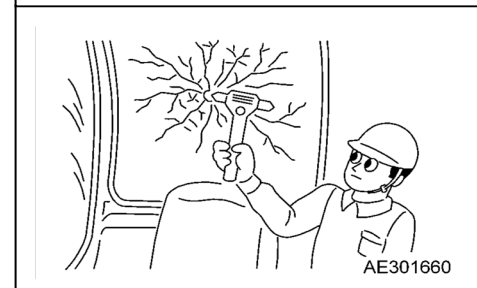



## 2.14 CAP AND COVER WITH LOCK

- Use the starter switch key to open and close the cap and cover with lock.
- Securely insert the key into the root (A) before turning. If the key is turned halfway, the key may be broken.

- See the illustration on the right for the position of the cap and cover with lock.

- (1) Machinery cover
- (2) Cab door
- (3) A/C filter
- (4) Left cover
- (5) Right cover

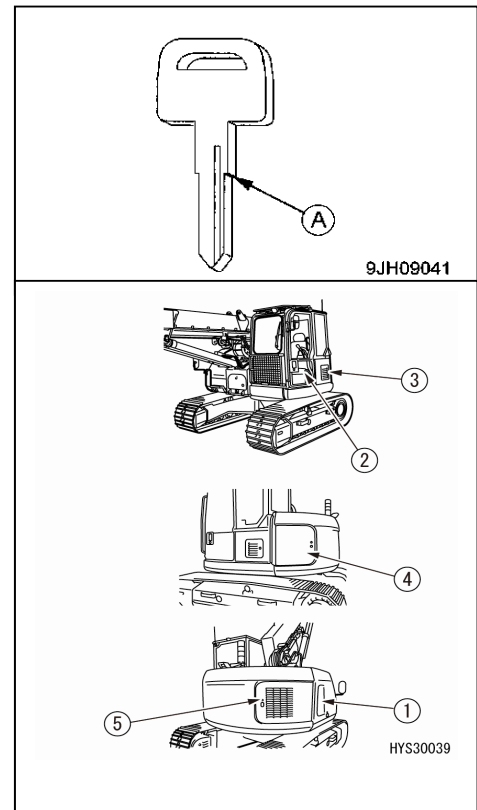

### Method of opening and closing the cover with lock (for cover with lock)

#### [When opening (when locked)]

1. Insert the key into the key groove.
2. Turn the key counterclockwise and pull the cover knob.  
The cover can be opened.  
Position of (A): Open (OPEN)  
Position of (B): Close (LOCK)

#### [When locking]

1. Close the cover and insert the key into the key groove.
2. Turn the key clockwise and pull out the key.

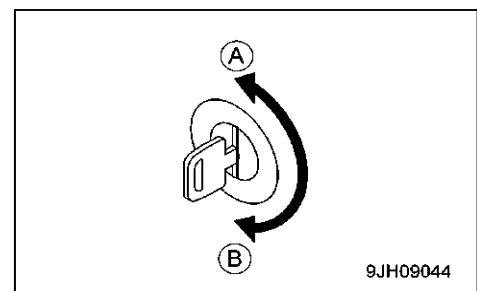

## 2.15 BATTERY ROOM DOOR

### **⚠ CAUTION**

- When performing inspection and maintenance inside the door, be sure to fix the door in an open condition by using the stopper.

1. Insert your finger into the door pull (1) and open the door (2).

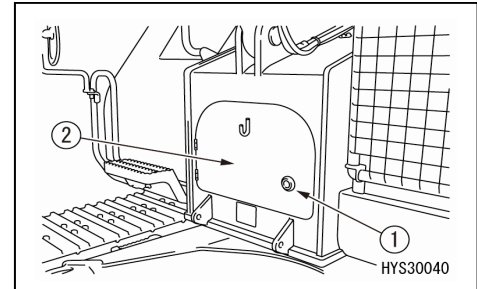

2. After opening the door (2), put the rod (3) in the groove to fix.

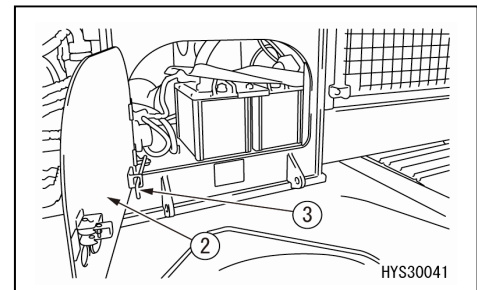

3. To close the door (2), lift the rod (3) to remove it from the groove and close the door.

## 2.16 LEFT COVER

### **⚠ CAUTION**

- When performing inspection and maintenance inside the door, be sure to fix the door in an open condition by using the stopper.
- Be sure to lock the door except when opening it.

1. Disengage the lock (1) of door locking.

2. Insert your finger into the door pull (2) and open the door (3).

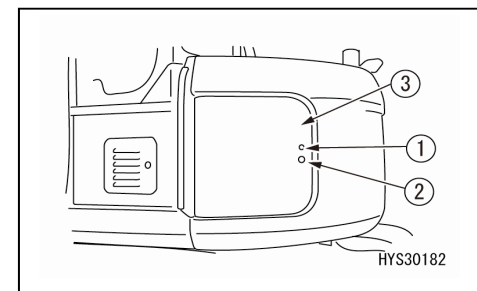

3. After opening the door (3), put the rod (4) in the groove to fix.

4. To close the door (3), lift the rod (4) to remove it from the groove and close the door.

5. Lock the door.

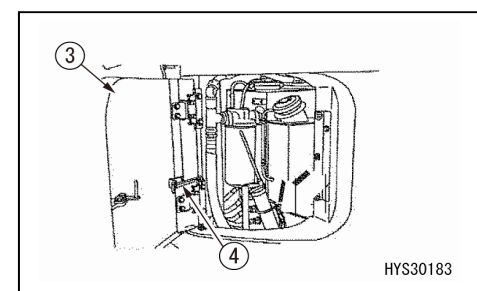

## 2.17 RIGHT COVER

### ⚠ CAUTION

- When performing inspection and maintenance inside the door, be sure to fix the door in an open condition by using the stopper.
- Be sure to lock the door except when opening it.

1. Disengage the lock (1) of door locking.
2. Insert your finger into the door pull (2) and open the door (3).
3. After opening the door (3), put the rod (4) in the groove to fix.
4. To close the door (3), lift the rod (4) to remove it from the groove and close the door.
5. Lock the door.

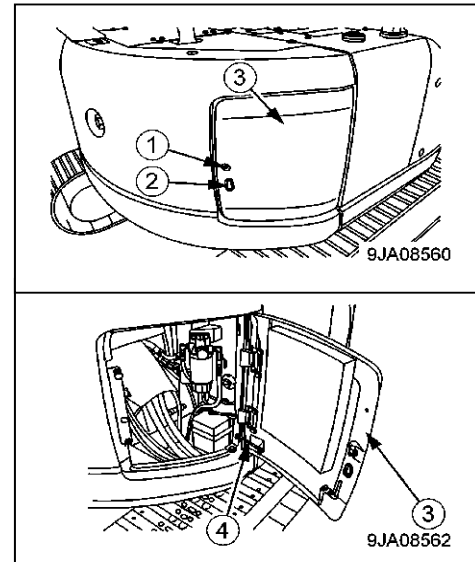

## 2.18 MACHINERY COVER

### **⚠ DANGER**

- Always use the designated place on the machinery cover, or you may slip and fall down. See "Safety 1.4 Cautions in getting on and off" for details.
- When performing inspection and maintenance inside the machinery cover, be sure to fix the machinery cover in an open condition by using the machinery cover supporting rods.
- Be sure to close the machinery cover for operation except for inspection.
- Be sure to lock the machinery cover except when opening it.

1. Insert the key into the machinery cover open knob (1) to make it "an open state".
2. After pulling out the key, open the machinery cover (2) while pushing the machinery cover open knob (1).
3. After opening the machinery cover, fix the machinery cover supporting rods (3) to the machinery cover fixing position.
4. To close the machinery cover (2), remove the machinery cover supporting rods (3) and securely fix it to the lever lock. Then, gently lower the machinery cover and push down the machinery cover to lock.
5. Insert the key into the machinery cover open knob (1) to make it "a lock state".

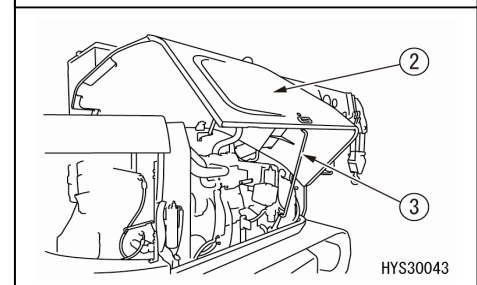
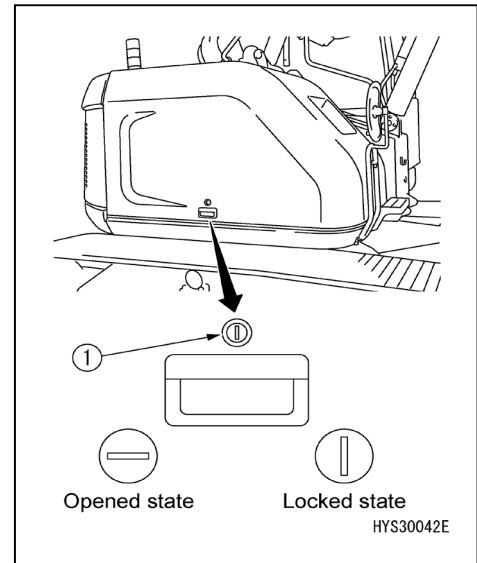

## 2.19 HOLDER FOR OPERATION MANUAL

A pocket for storing the operation manual is provided in the left side of the cab.

Put the operation manual in this pocket so that you can see it whenever you need it.

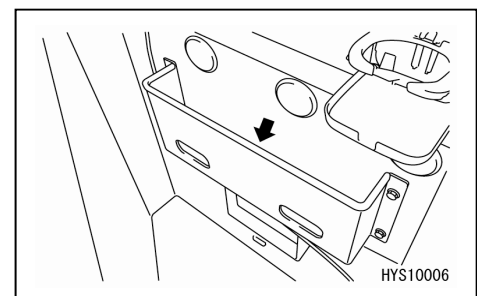

## 2. 20 GREASE PUMP HOLDER

This is located in the left door on the rear left. If you are not using the grease pump, hang it on this holder.

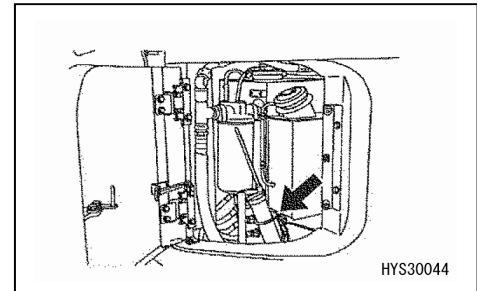

## 2. 21 CUP HOLDER

This is located on the left side in the cab.

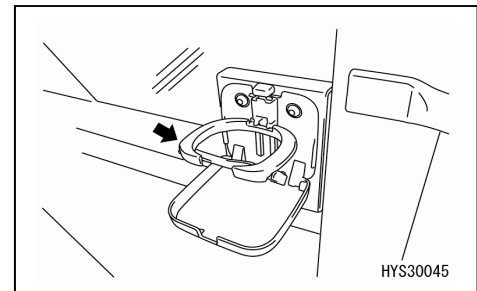

## 2.22 RETRACTABLE SEAT BELT HANDLING

### **⚠ WARNING**

- Before wearing the seat belt, check that the belt mounting bracket and installed belt have no abnormality.  
If they are worn or damaged, replace them with new ones.
- Replace the seat belt with a new one every three years even if there is no abnormality on the belt appearance.  
"The date of manufacture" is woven in the back of the belt.
- Be sure to wear the seat belt during operation.
- Do not wear the seat belt in a twisted condition.

As this seat belt has a retractable device, it is not necessary to adjust the length.

### [1] HOW TO WEAR SEAT BELT

Pull out the belt from the retractable device (1) holding the grip (2) and check that there is no twisting. Then, insert securely the insertion section (3) into the buckle (4).

At this time, pull the belt lightly and check that the belt is securely locked.

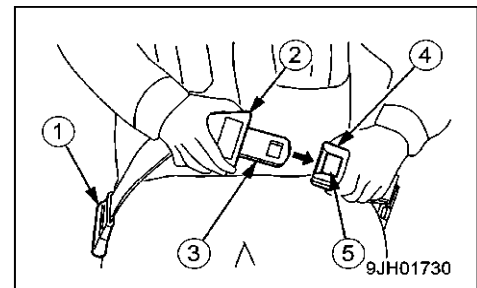

### [2] HOW TO UNFASTEN SEAT BELT

When the button (5) of the buckle (4) is pressed, the insertion section (3) comes off from the buckle (4).

As the belt is automatically retracted, hold the grip (2) and slowly return it to the retracting device (1).

### 3. OPERATION

#### 3.1 PRE-OPERATION INSPECTION

##### 3. 1. 1 CHECKING BEFORE STARTING ENGINE

**⚠ WARNING**

- This machine is equipped with a diesel engine.  
If you smell fuel around the engine, it may be leaking. Carefully check for cracks on the fuel hose or fuel hose connections.
- Build up of combustibles and oil leakage around the hot engine section such as engine and muffler and around the battery can cause fire in the machine.  
Make a thorough walk-around inspection. If any abnormality is found, be sure to repair it or consult us or our sales service agency.

Check the following in this section by making a walk-around inspection before starting the work every day.

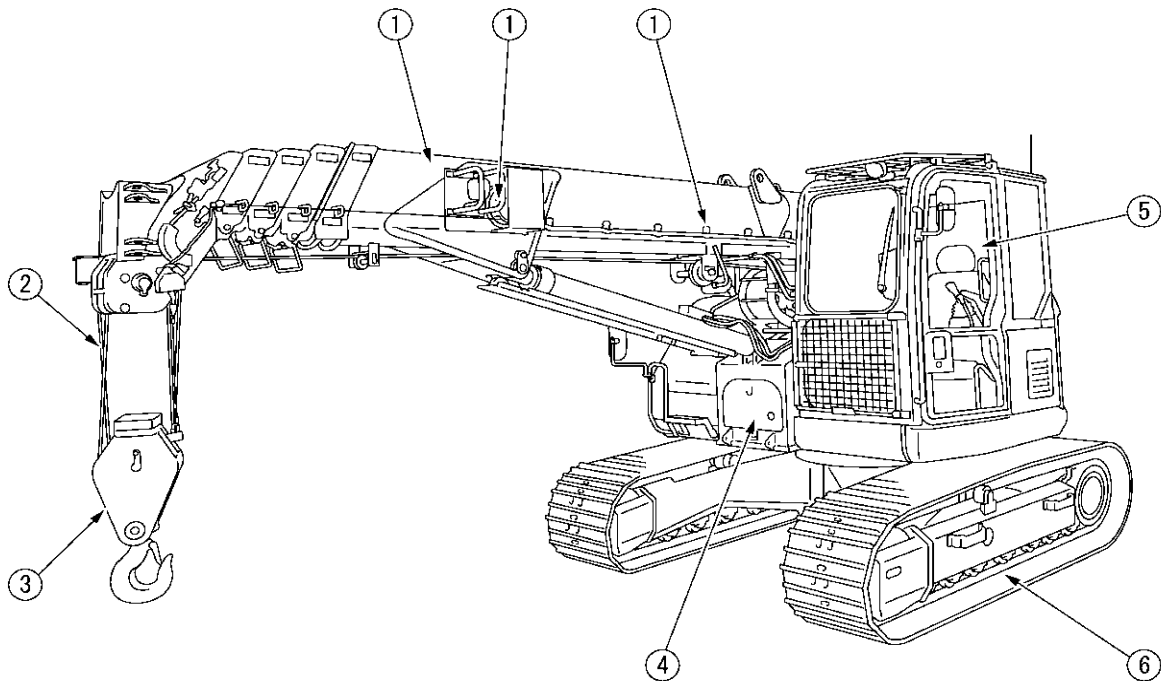

HYS30051



### [1] INSPECTION AROUND CRANE

- Look around the surrounding area and lower parts of the boom and boom mounts to check for oil leaks. In particular, thoroughly inspect the derricking cylinder and the lower part of the winch motor around the mounts. Repair if any abnormality is found.
- Check parts of the mount for cracks, noticeable deformation and contamination. Check also the bolts, nuts, pins and piping connections for looseness, falling off or damage. Repair if any abnormality is found.
- Check parts of the boom for cracks, noticeable deformation and contamination. Check also bolts, nuts, pins and piping connections for looseness, falling off or damage. In particular, check boom supporting pins and derricking cylinder supporting pins for remarkable wear and damage. Repair if any abnormality is found.
- Check the wire rope for the over winding detection weight of the over hoist detector at the boom tip for noticeable damage and deformation.  
Repair if any abnormality is found.
- Check the working lamp for breakage, noticeable deformation or contamination. Repair if any abnormality is found. Clean if there is any contamination.
- Check the electric wiring for slackness, connections for looseness and traces of burning. Repair if any abnormality is found.

### [2] INSPECTION OF WIRE ROPE

★See "Operation 4. Wire Rope Handling" for details.

- Check the wire rope for damage, deformation, wear, twist, kinks or corrosion. Replace if any abnormality is found.
- Inspect the binding condition of the wire rope end. Replace if the wire rope end is loosened.
- Check the wire rope for irregular winding (winch drum part). Rewind if there is irregular winding.

### [3] INSPECTION OF HOOK BLOCK

- Inspect if the wire rope latch (1) functions properly. Repair if any abnormality is found.
- Turn the hook and inspect if it turns smoothly and if any abnormal noise is generated from the trunnion.  
Repair if any abnormality is found.
- Check the hook for cracks and noticeable deformation.  
Repair if any abnormality is found.
- Replace the hook if the dimension **a** between punch marks stamped on the hook is **122.4mm** or more and the dimension **b** of the lower part of the hook is **70.8mm** or less.

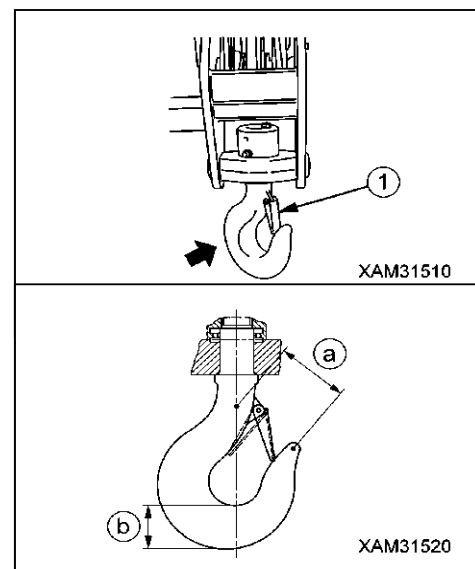



#### **[4] INSPECTION AROUND UPPER SLEWING BODY**

- Inspect if there are fuel leaks, oil leaks and water leaks from the engine. Repair if any abnormality is found.
- Check for any accumulation or deposits of inflammable items including fallen leaves, wastepaper, dust, oil or grease in high temperature areas such as engine and muffler and around the battery. Remove any accumulation or deposits.
- Check the electric wiring of the starter, alternator and around the battery for slackness, connections for looseness or traces of burning. Repair if any abnormality is found.
- Inspect if there are oil leaks from hydraulic equipment, hydraulic oil tank, hydraulic hose and joints. Repair if any abnormality is found.
- Check handrails and steps for cracks, noticeable deformation or contamination. Repair if any abnormality is found. Check also bolts, nuts for looseness, falling off and damage. Repair if any abnormality is found.
- Check the rotating warning lamp and rear view camera for breakage, noticeable deformation or contamination. Repair if any abnormality is found. Clean if there is any contamination.

#### **[5] INSPECTION OF CABIN**

- Inspect if windows have come off or broken and if window glasses are cracked or broken. Repair if any abnormality is found.
- Check the seat belt and mounting brackets for abnormality. Repair if any abnormality is found.
- Inspect if each operation lever, travel lever, lock lever and accelerator pedal operate smoothly. Repair if any abnormality is found.
- Check the moment limiter display part and monitor panel for damage and contamination. Repair if any abnormality is found. Clean if there is any contamination.
- Check the electric wiring for slackness and connections for looseness or traces of burning. Repair if any abnormality is found.
- Check the headlamp for breakage, noticeable deformation or contamination. Repair if any abnormality is found.

#### **[6] INSPECTION OF BASE CARRIER**

- Check parts of undercarriage (frame, crawler, each roller, idler and sprocket) for cracks, noticeable deformation and contamination. Check also bolts, nuts, pins for looseness, falling off and damage. Repair if any abnormality is found.
- Look around the undercarriage and its lower part and check bolts, nuts, pins and piping connections for looseness, falling off, damage and oil leaks. Repair if any abnormality is found.

### 3. 1. 2 CHECKING BEFORE STARTING ENGINE

Check the following in this section without starting the engine and before starting work every day.

#### [1] CHECKING/REFILLING ENGINE COOLANT

##### **⚠ WARNING**

- Do not open the radiator cap when engine is hot. Inspect the coolant in the sub tank after the engine is cold.
- The coolant is at elevated temperature after the engine is stopped. Besides, pressure is accumulated inside the radiator. If the cap is opened in this state, the coolant may blow out, causing burns. When removing the radiator cap, turn it slowly to release pressure after the coolant temperature lowers and carefully remove it.

1. Place the machine on a level surface.
2. Open the machinery cover.
3. Inspect the sub tank (1) level and check that the coolant is between "FULL" and "LOW".
4. If the coolant level is lower than the "LOW" level, use the following procedure to refill tap water.
  - (1) Remove the sub tank (1) cap and refill water from the feed port to the "FULL" level.
  - (2) After refilling coolant, securely close the sub tank (1) cap.

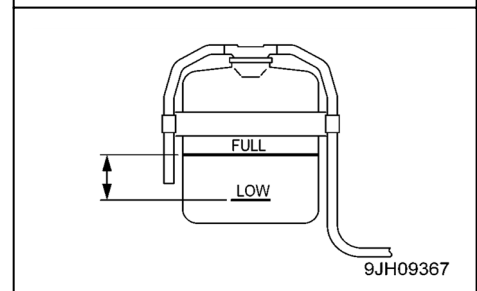
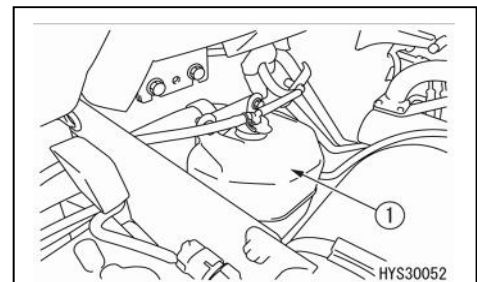

##### **CAUTION**

- If the sub tank is empty, water leaks are to be considered. Repair if any abnormality is found after inspection.
- If no abnormality is found, inspect the coolant level in the radiator. If coolant is low, feed coolant to the radiator and then to the sub tank.

#### [2] CHECKING OIL LEVEL AND REFILLING OIL IN ENGINE OIL PAN

##### **⚠ WARNING**

- As parts and oil will be hot immediately after the engine stops, you may suffer burns. Wait until the temperature drops, then start the work.



## CAUTION

- See “MAINTENANCE 7.1 USE OF FUEL AND LUBRICATING OIL ACCORDING TO TEMPERATURES” for the oil to be used. Using oil other than those specified may shorten the life of the engine. Be sure to refill with the specified oil.
- Keep the engine oil at an appropriate level.  
The oil level being too high will result in too much oil consumption and this tends to increase the oil temperature, deteriorating the oil faster. The oil level being too low may burn out the engine.
- Be careful not to let any foreign substance go into the filler opening when refilling the oil.

1. Place the machine on a level surface.
2. Open the machinery cover.
3. Pull the oil level gauge (1) out and wipe the oil with a disposable cloth.
4. Insert the oil level gauge (1) into the gauge guide as far as it goes and pull it out.
5. If the oil level is between the “H” mark and “L” mark on the oil level gauge (1), the oil level is normal.
6. If the oil level is lower than the “L” mark, remove the oil filler cap (2) and refill the engine oil from the filler opening.
7. Securely install the oil level gauge (1) and filler cap (2) after refilling the oil.

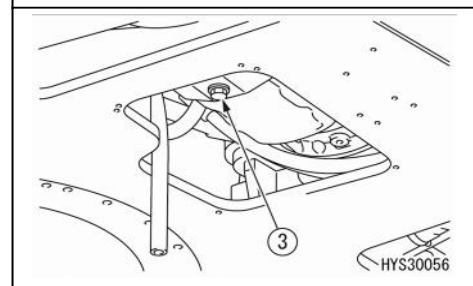
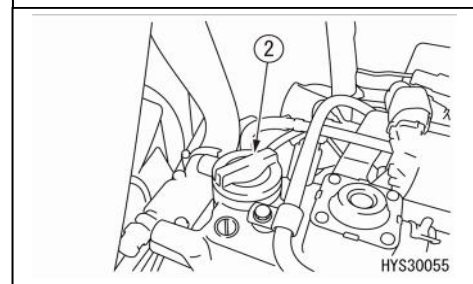
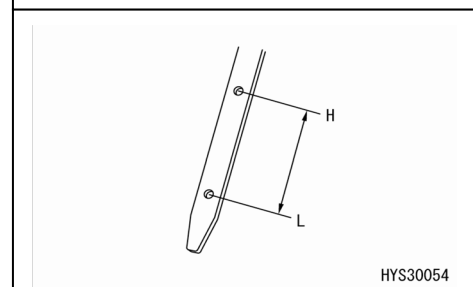
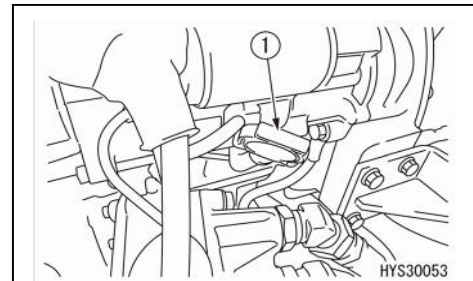

## NOTES

If the oil level is above the "H" mark, remove the under cover, drain the excess quantity from the drain bolt (3) and check the oil level again.

**[3] CHECKING FUEL LEVEL AND REFILLING FUEL IN FUEL TANK**

**⚠ DANGER**

- Be extremely careful with fire such as cigarettes.
- Always stop the engine before refilling fuel. Refilling the oil when engine is running may cause leaked fuel to draw fire from hot muffler or other hot areas.
- Overfilling the fuel results in spillage and is dangerous. Refuel to the level slightly lower than the specified upper limit level.  
Always wipe away cleanly whenever the fuel spills.
- Securely close the tank cap after refuelling.

**CAUTION**

- See "MAINTENANCE 7.1 USE OF FUEL AND LUBRICATING OIL ACCORDING TO TEMPERATURES" for the fuel to be used.
- Be careful not to let any foreign substance go into the filler opening when refueling.

1. Place the machine on a level surface.
2. Turn the starter switch to the "ON" position and check the remaining quantity in the fuel gauge on the monitor panel. After inspection, return the starter switch to the "OFF" position.
3. If the fuel runs short, open the filler opening (F) on the top face of the fuel tank and refill the fuel from the filler opening until the float gauge (G) rises to the highest position.
  - Specified quantity of fuel tank: 140 l
4. Securely close the filler cap (F) after refueling.

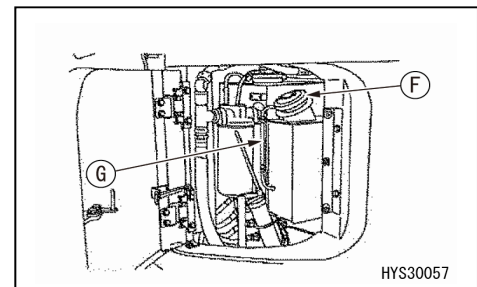
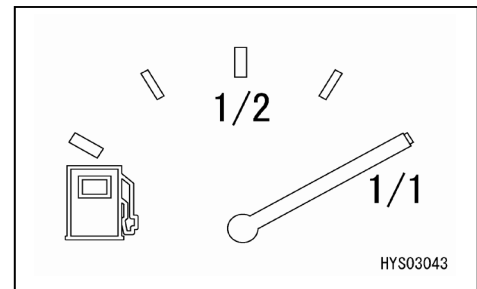

**NOTES**

If the breather hole (3) of the cap is clogged, the pressure in the tank decreases (becomes negative pressure) and the fuel may not flow out. Clean the hole occasionally.

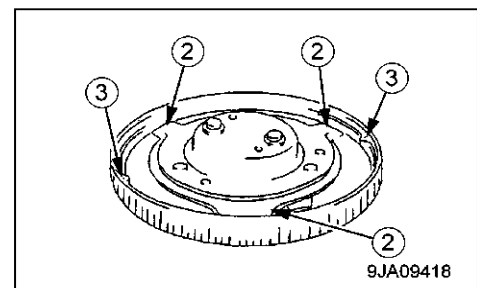



**[4] CHECKING OIL LEVEL AND REFILLING OIL IN HYDRAULIC OIL TANK**

**⚠ WARNING**

- As parts and oil become hot immediately after the engine stops, you may suffer burns. Wait until the temperature drops, then start the work.
- The oil may spurt out when the filler cap is removed. Turn the cap slowly to release the internal pressure before removing.
- Securely close the tank cap after refueling.

**CAUTION**

- See “MAINTENANCE 7.1 USE OF FUEL AND LUBRICATING OIL ACCORDING TO TEMPERATURES” for the oil to be used.
- Be sure to put the machine in the travelling posture when checking the oil level. Checking the oil level in the working position will cause overfilling since the oil in the cylinders has not returned to the tank.
  - ★See “OPERATION 3.7 MACHINE TRAVELLING POSTURE” for details.
- Be careful not to let any foreign substance go into the filler opening when refilling the oil.

1. Place the machine on a level surface.
2. See “OPERATION 3.7 MACHINE TRAVELLING POSTURE” and put the machine in the "Travelling posture".
3. Turn the starter switch to the "ON" position.
4. Within 15 seconds after engine stop, operate the operation levers (crane, travelling) in a full stroke in each direction to release the internal pressure.
5. Open the left cover and inspect the sight gauge (G). It is correct if the oil level is between "H - L".

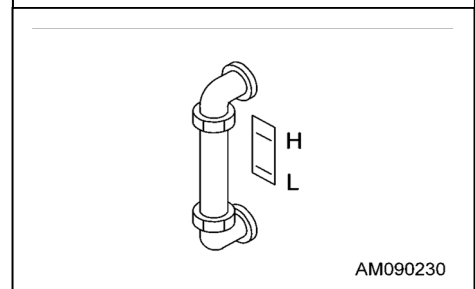
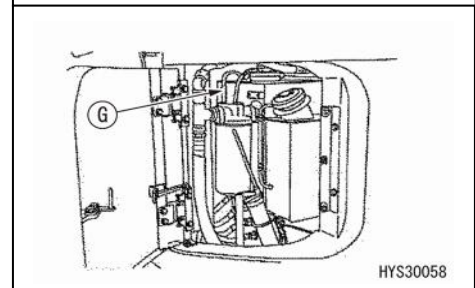
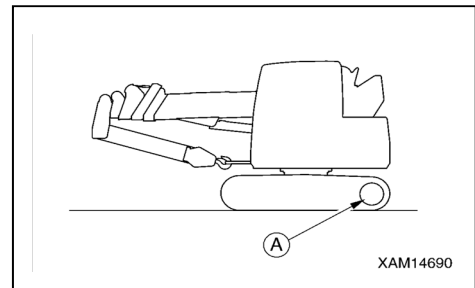

6. If the oil level is below the "L" level, refill hydraulic oil from the filler opening (2).

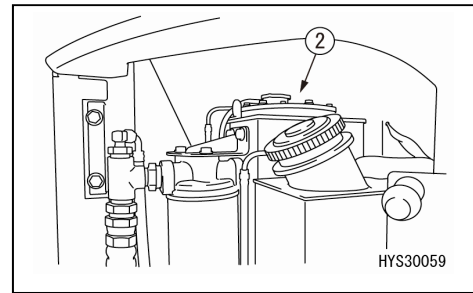

### CAUTION

When refilling, avoid the oil exceeding "H" of the level gauge.

Otherwise, the hydraulic circuit may be damaged or the oil may spurt out.

If the oil is refilled to the level exceeding "H", drain the excess oil in the following steps.

1. Slew the revolving super structure so that the drain plug (3) on the bottom of the tank is located between the right and left crawlers.
2. Stop the engine and wait until the hydraulic oil cools down.
3. Remove the drain plug (3) to drain the oil.
4. Inspect the oil level again.

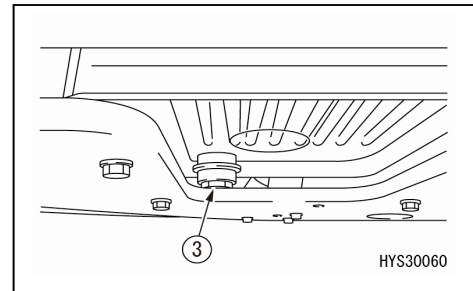

### [5] INSPECTION OF DUST INDICATOR

1. Open the right cover and inspect if the red piston has come out from the dust indicator (1).
2. Immediately clean or replace the element if the red piston has come out.  
See "MAINTENANCE 10.3 [3] CHECKING/CLEANING/REPLACING AIR CLEANER " for details.
3. After inspection, cleaning and replacement, push the knob of the dust indicator (1) to return the red piston to the original position.

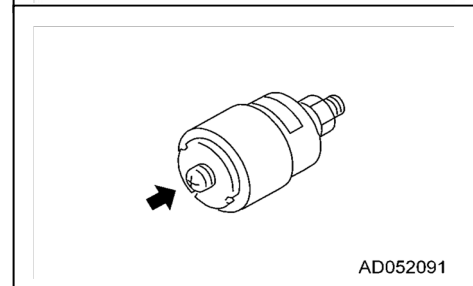
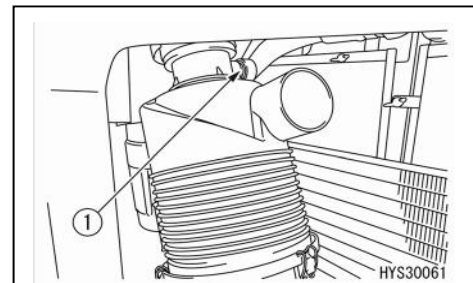



**[6] INSPECTING WATER SEPARATOR AND DRAINING CONTAMINANT WATER/DEPOSITS**

**⚠ WARNING**

- The water separator has fuel (diesel fuel) inside. Be extremely careful of fire such as cigarettes when cleaning the transparent cap of the water separator.
- If the fuel spills when water is drained from the water separator or the water separator is replaced, be sure to wipe it off.

**CAUTION**

- Water or dust accumulated inside the water separator will cause engine failure. Check inside the transparent cap and drain any water or dust accumulated inside.
- If water accumulates in the water separator transparent cap, it is assumed that water is also mixed in the fuel tank. Drain water and dust mixed in the fuel tank.
- If water in the water separator transparent cap freezes, check that frozen water melts completely before draining water.

**[Water draining]**

- The water separator is integral with the fuel filter, and inspect the water separator of the main filter (1) and sub filter (2), respectively.
- Prepare for a container which receives drained water.

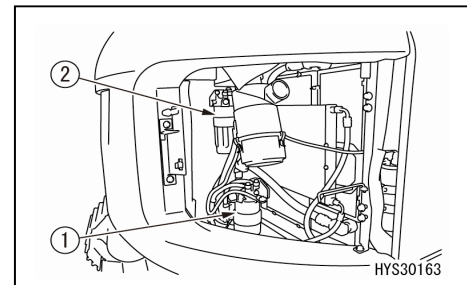

**[Main filter]**

1. Place the machine on a level surface.

2. Open the right cover of the machine body.

3. Inspect the transparent cap (2) and check if water and deposits accumulate in the transparent cap (2).

4. If water accumulates in the transparent cap (2), drain water in the following steps.

- (1) Set a container which receives drained water under the drain plug (4).
- (2) loosen the air bleeder plug (3).
- (3) Loosen the drain plug (4) to drain water accumulated inside.
- (4) After water is drained, be sure to tighten the air bleeder plug (3) and drain plug (4) to conduct air bleeding of fuel. (See P. 3 - 141)

Tightening torque

Air bleeding plug (3) 10.0 N·m {1.0 kgf·m}

Drain plug (4) 2.0 N·m {0.2 kgf·m}

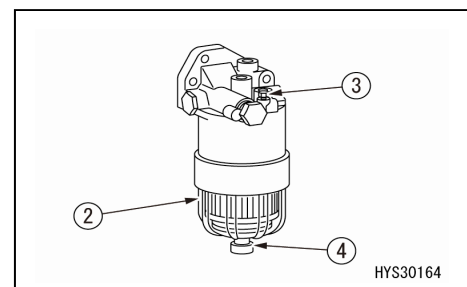



## NOTES

- If it is difficult to see the transparent cap (2) because it is dirty, clean the transparent cap (2) when replacing the fuel prefilter cartridge.

5. Close the right cover of the machine body.

### [Sub filter]

1. Inspect in the same steps as the main filter.

### [7] DRAINING CONTAMINANT WATER/DEPOSITS IN FUEL TANK

- Prepare a container to receive drained water.

1. Slew the revolving super structure so that the drain valve (1) on the bottom of the tank is located between the right and left crawlers.

2. Stop the engine and prepare a container to receive drained fuel under the drain valve (1).

3. Open the drain valve (1) to drain deposits and water accumulated on the bottom together with fuel.  
At this time, be careful not to get covered with fuel.

4. Close the drain valve (1) when only clean fuel flows out.

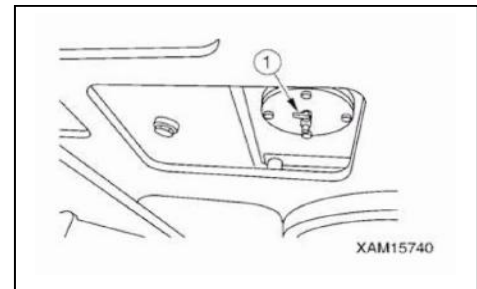

## [8] CHECKING ELECTRIC WIRING

### ⚠ CAUTION

- When a fuse blows frequently or there is a trace of short circuit in the electric wiring, immediately request us or our sales service agency for the investigation of the cause and repair.
- Keep the top face of the battery clean and inspect the vent hole of the battery cap. If it is clogged with mud, wash the battery cap with water to remove clogging.

Inspect if fuses are damaged, fuses of the specified capacity are used, there is a trace of a break or short circuit in the electric wiring, sheaths are damaged or terminals are loosened. If loosened, retighten them.

In particular, inspect the wiring of "Battery", "Starter" and "Alternator".

Be sure to inspect if combustibles accumulate around the battery and remove them.

## [9] CHECKING WORKING LAMP

Check if the working lamp and headlamps turn on properly or if they are dirty or damaged.

1. Turn the starter switch to the "ON" position.
2. Turn the lamp switch to the "ON" state to check if the working lamp turns on.

If it does not, a blown bulb or wiring failure is likely. Contact us or our sales service agency for repair.

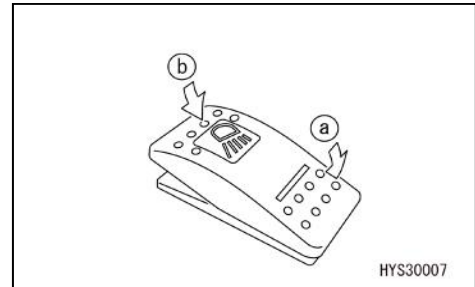

## [10] CHECKING HORN FOR FUNCTION

1. Turn the starter switch to the "ON" position.
2. Press the horn switch to verify that the horn sounds at once.  
If the horn does not sound, contact us or our sales service agency for repair.

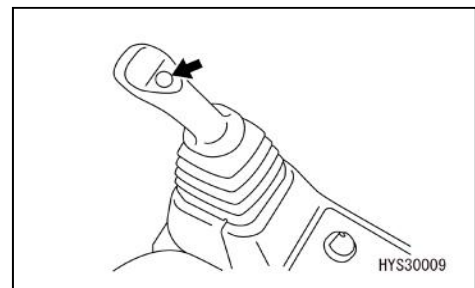

**[11] ADJUSTING THE OPERATOR'S SEAT**

**⚠ WARNING**

- Adjust the seat before operation or when a driver changes.
- Adjust the seat with your back pushed against the seat back of the driver seat so that you can sufficiently operate the operation levers, switches and accelerator pedal.
- Be sure to stop the engine before adjusting the driver seat.

**[A] FORE AND AFT ADJUSTMENT OF SEAT**

Pull the lever (1) upward, adjust the seat to the desired position and release your hand from the lever (1).

**[B] RECLINING ADJUSTMENT OF SEAT**

**NOTES**

The reclining amount of the seat is large when the seat is moved forward and becomes smaller as the seat moves backward.  
Return the seat back to the original position when moving the seat backward.

Pull the lever (2) upward, adjust the seat back to the easy-to-operate position and release your hand from the lever (2). Bring your back into intimate contact with the seat back for adjustment. The seat back may suddenly return if your back is off.

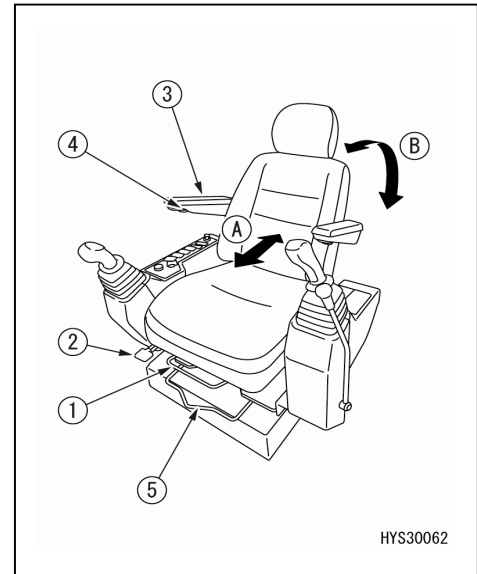

**[C] ANGLE ADJUSTMENT OF ARM REST**

The arm rest (3) can be raised up to the angle of approximately 90 degrees by hand. You can make fine adjustments of the arm rest (3) angle vertically by turning the dial (4) on the lower part of the arm rest (3).

Arm rest adjustment angle: 30 degrees

**NOTES**

The arm rests are designed to be raised automatically if the seat back is folded forward without raising the arm rests (3).

**[D] FORE AND AFT ADJUSTMENT OF WHOLE SEAT**

Pull the lever (5) upward, adjust the seat to the desired position and release your hand from the lever (5).

The seat, right and left work equipment operation levers and lock lever slide (move) together.

Fore and aft adjustment amount: 80 mm (8 stages)

**[12] ADJUSTMENT OF MIRRORS**

**⚠ WARNING**

Be sure to adjust the mirrors before operation. If the mirrors are poorly adjusted, the visibility can not be secured, resulting in disorder or serious physical injury.

**[MIRROR (A)]**

Adjust the mirror mounting so that a person at the rear left of the machine is in view.

- Install the mirror at the position shown in the illustration on the right.
  - ★ Dimension (E): 100 mm
- Fix the mirror stay (1) with the mirror position extended to the maximum.
- If the mirror movement is stiff during adjustment, loosen the mirror bolt (2) and mirror mounting bolt (3) to adjust.
  - ★ Tightening torque of bolt (2): 15.7 - 19.6 Nm (1.6 - 2.0 kgfm)
- Adjust so that the side of the machine body is reflected in the mirror as shown in the illustration on the right.

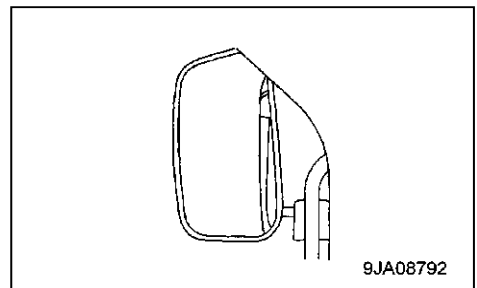
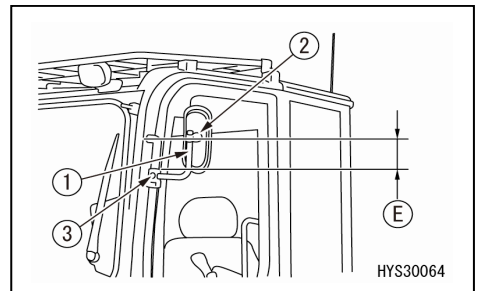
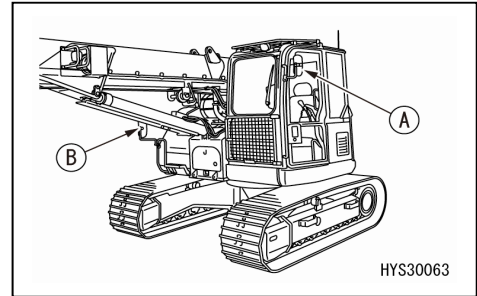

**[MIRROR (B)]**

Adjust the mirror mounting so that a person at the right side of the machine is in view.

- Install the mirror at the position shown in the illustration on the right.
- If the mirror movement is stiff during adjustment, loosen the mirror nut (4) to adjust.

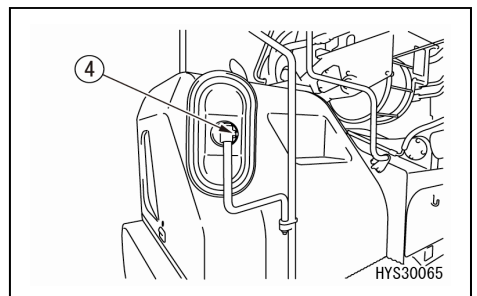

[13] ADJUSTMENT OF MIRROR FOR CHECKING IRREGULAR WINDING

**⚠ CAUTION**

Be sure to adjust the mirrors before operation. If the mirror is poorly adjusted, irregular winding caused by the winch drum cannot be checked. This not only damages the wire rope, but also shakes a hoisted load at the time of lowering, leading to instability and serious physical injury.

Adjust the mirror (1) mounting so that an operator has a good view of the winch drum.

- If the mirror movement is stiff during adjustment, loosen the mirror bolts to adjust.

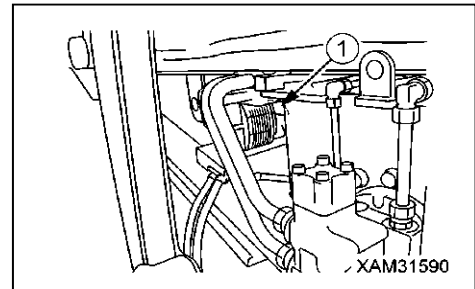

### [14] ANGLE ADJUSTMENT OF REAR VIEW CAMERA

If images displayed on the monitor are not in the right position, remove the cover (1) and adjust the mounting angle (A) of the rear view camera.

1. Remove the bolt (2) (2 locations) to remove the cover.

2. Loosen the camera mounting bolt (3) on both sides and adjust the camera mounting angle (A).

3. After adjustment, tighten the bolt (3).

4. After adjustment, install the cover (1).

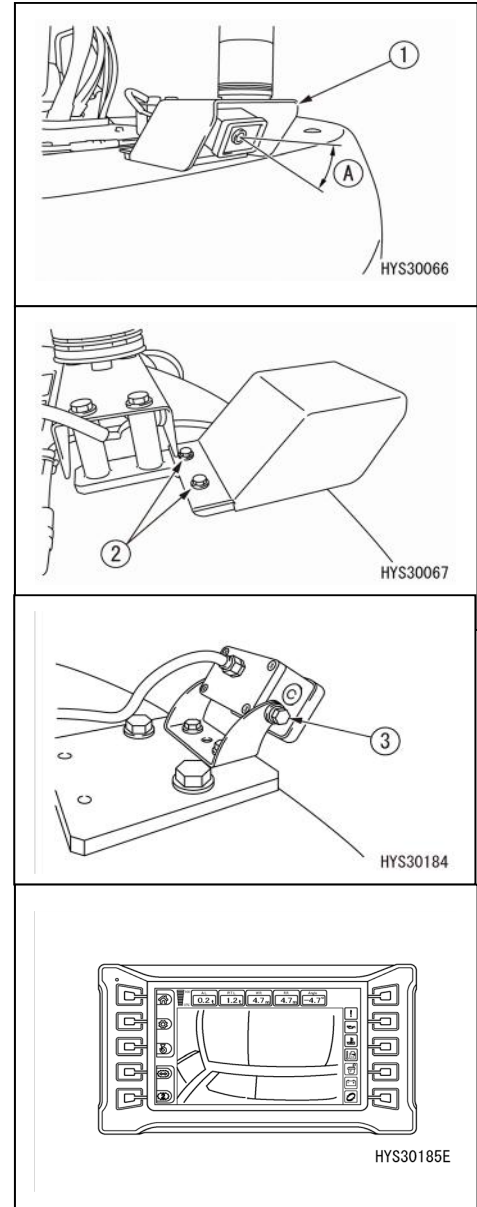

**[15] CHECKING BATTERY ELECTROLYTE LEVEL**

**⚠ WARNING**

- Do not use the battery with its electrolyte level kept below "LOWER LEVEL " (minimum electrolyte level line). The deterioration inside the battery is promoted, and not only is the battery life is shortened, but also the battery may burst (explode).
- The electrolyte generates combustible gas and presents explosion hazard. Do not bring any fire close to the electrolyte.
- The electrolyte is a hazardous substance. Avoid contact with eyes or skin. Should it come into contact with eyes or skin, wash the affected area with plenty of water and consult a physician.
- Do not refill the electrolyte above the upper limit "UPPER LEVEL" (highest electrolyte level). Otherwise, the electrolyte may spill, damaging the paintwork or corroding parts.

**CAUTION**

- Wipe the top of the battery with a moist cloth to keep it clean.
- Purified water (example: commercial battery replenisher) should be refilled before starting work the next day to avoid freezing.

Be sure to perform a battery electrolyte level check at least once a month according to the following standard.

Check the 2 batteries at the same time.

Check using the following method if the electrolyte level can be checked from the side of the battery.

1. Open the battery room door (1).

**[WHEN CHECKING ELECTROLYTE LEVEL FROM BATTERY SIDE]**

1. Clean the periphery of the battery electrolyte level line with a cloth soaked in water and check that the electrolyte level is between "UPPER LEVEL" (highest electrolyte level line) and "LOWER LEVEL" (lowest electrolyte level line).

**NOTES**

If a dry cloth is used for cleaning, the battery may ignite and explode due to static electricity.

2. If the electrolyte level falls below half of the range between the highest electrolyte level line and lowest electrolyte level line, lift up the vinyl cover (1), remove all caps (2) of the battery and refill purified water to the highest electrolyte level line.

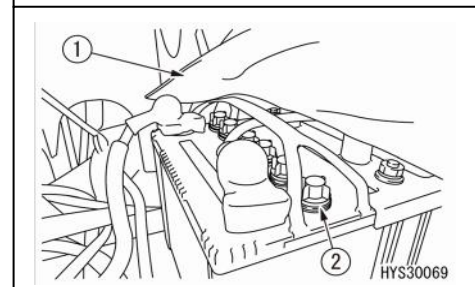
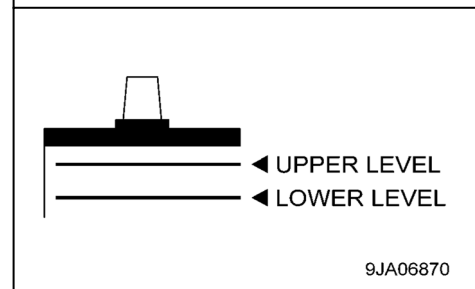
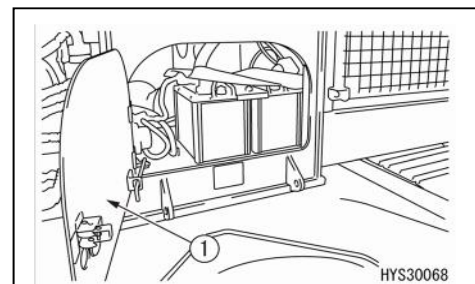

3. After refilling, securely tighten all the caps (2).

**NOTES**

If purified water should be refilled above the highest electrolyte level line, use a syringe to extract it up to the highest electrolyte level line.

For the extracted liquid, after neutralizing it with baking soda, wash it away with a lot of water. Or consult us or our sales service agency, or battery manufacturer.

**[WHEN CHECKING ELECTROLYTE LEVEL FROM BATTERY TOP]**

Check in the following method if the electrolyte level cannot be checked from the battery side or there is no indication of "UPPER LEVEL" (highest electrolyte level line) on the side.

1. Lift up the vinyl cover (1) installed on the battery.
2. Remove all the caps (2) on the top face of the battery and look into the liquid filling opening (3) to check.

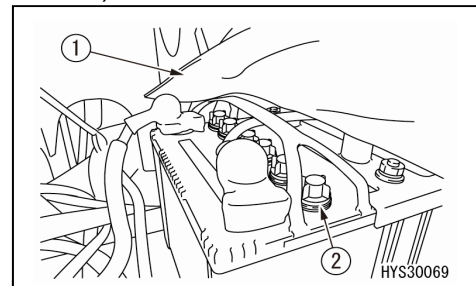

3. If the electrolyte level does not reach the sleeve (4), be sure to refill purified water up to the bottom (highest electrolyte level) of the sleeve (4).

- (A) Proper amount: As the electrolyte level reaches the bottom of the sleeve, it swells due to surface tension and the plate looks contorted.
- (B) Small amount: As the electrolyte level does not reach the bottom of the sleeve, the plate does not look contorted and looks plate-like in shape.

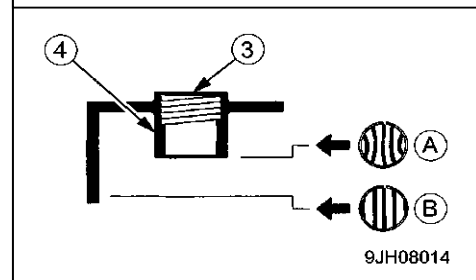

4. After refilling, securely tighten all the caps (2).

**NOTES**

If purified water should be refilled above the bottom of the sleeve, use a syringe to extract it up to the bottom of the sleeve.

For the extracted liquid, after neutralizing it with baking soda, wash it away with a lot of water. Or consult us or our sales service agency, or battery manufacturer.

**[WHEN ELECTROLYTE LEVEL CAN BE CHECKED BY INDICATOR]**

If the electrolyte level can be checked by the indicator, etc., follow the instruction.





### 3. 1. 3 CHECKING AFTER STARTING ENGINE

Check the following in this section after starting the engine and before starting the work every day.

#### **CAUTION**

**The checkups described in this section should be carried out after starting the machine. See "OPERATION 3.2 OPERATIONS AND CHECKS BEFORE STARTING ENGINE " and later to execute the engine start up, travelling operations and crane operations.**

#### **[1] CHECKING EASE OF ENGINE CRANKING AND ABNORMAL NOISE**

Check, before starting the engine, if there is any abnormal noise and if the engine can be easily cranked.

Also check if there is any abnormal noise in an idle state and a state in which the engine speed is slightly increased.

- When there is abnormal noise at the time of engine start, the engine may be damaged if the engine is operated as it is.

Contact us or our sales service agency to request inspection in good time.

#### **[2] CHECKING LOW SPEED AND ACCELERATION STATE OF ENGINE**

Check if variations in engine rotation occur or the engine suddenly stops when the machine stops in normal travelling.

Check if the engine accelerates smoothly when the fuel adjustment dial is turned to the full rotation position (MAX).

- Pay due attention to the surroundings and check in a safe place.
- When the low speed and acceleration state is substantially poor, an unexpected accident may be caused such as by the damaged engine, confused operation feel and worsened brake effectiveness, if the state is continued.

Contact us or our sales service agency to request inspection in good time.

#### **[3] CHECKING ENGINE EXHAUST GAS COLOUR, ABNORMAL NOISE AND VIBRATION**

Set the engine at idle and continue the operation under no load for approximately five minutes.

Verify that the engine exhaust gas color is either transparent or slightly blue. Also, check for abnormal noises and vibrations. Repair if any abnormality is found.

**[4] CHECKING CRANE OPERATIONS**

**⚠ WARNING**

When performing an operation check of the crane, see "OPERATION 3.15 OPERATION BEFORE CRANE WORK" to "OPERATION 3.22 CRANE STOWAGE OPERATION" and observe the procedure and precautions.

1. Verify that the boom rises smoothly when the right work equipment operation lever is operated to "RAISE" side (pulled inside). In addition, verify that the boom lowers smoothly when the right work equipment operation lever is operated to "LOWER" side (pushed outside). At this time, check if abnormal noise is generated from various parts of the boom or boom derrick cylinder.

Repair if any abnormality is found.

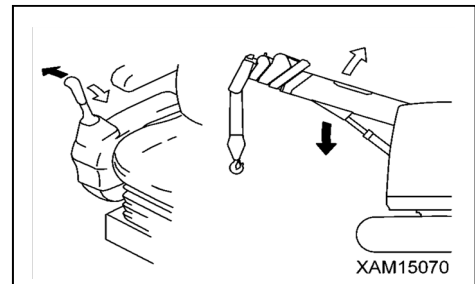

2. Verify that the boom extends smoothly when the left work equipment operation lever is operated to "EXTEND" side (pushed forward). Verify that the boom retracts smoothly when the left work equipment operation lever is operated to "RETRACT" side (pulled backward). At this time, check if abnormal noise is generated from various parts of the boom or boom telescopic cylinder. Repair if any abnormality is found.

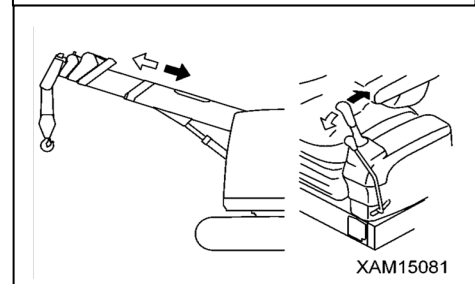

3. Verify that the hook is wound down smoothly when the right work equipment operation lever is operated to "DOWN" (pushed forward). In addition, verify that the hook is wound up smoothly when the right work equipment operation lever is operated to "UP" (pulled backward). At this time, check if abnormal noise is generated from various parts of the boom and winch motor. Repair if any abnormality is found.

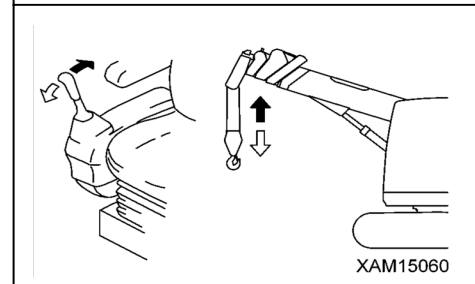

4. Verify that the revolving super structure (boom) slews counterclockwise smoothly when the left work equipment operation lever is operated to "LEFT SLEWING" side (pushed outside). In addition, verify that the crane slews clockwise smoothly when the left work equipment operation lever is operated to "RIGHT SLEWING" side (pulled inside). At this time, check if abnormal noise is generated from the slewing equipment. Repair if any abnormality is found.

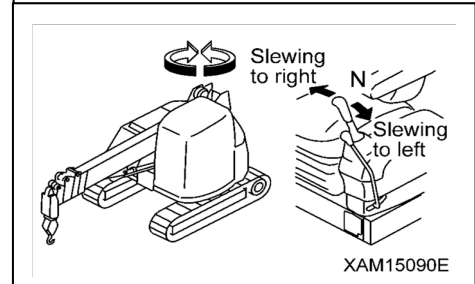

**[5] CHECKING OVER HOIST PREVENTION DEVICE**

When performing the winch winding up operation and boom extending operation with the hook block (1) in a overwound state (a state in which the hook block (1) pushes up the weight (3)), check that the buzzer sounds intermittently and that the winch winding up operation and boom extending operation automatically stopped.

If these events do not happen, the over hoist detector (2) may be faulty.

If the alarm does not stop sounding, the over hoist detector (2) may be faulty or the circuit may be open.

Ask us or our sales service agency for repair.

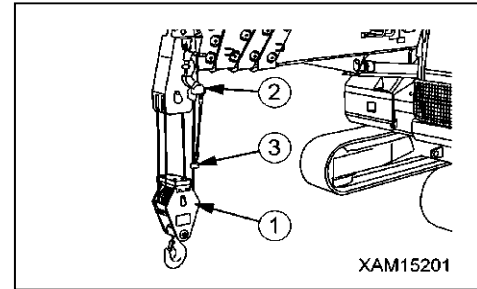

**[6] INSPECTION OF MOMENT LIMITER**

**⚠ WARNING**

**When an abnormality occurs in the moment limiter, immediately contact us or our sales service agent.**

1. Turn "ON" the starter switch.
2. Check the rotating warning lamp. After the rotating warning lamp of all colors illuminates for approximately 3 seconds, the green rotating warning lamp illuminates.
3. Start the engine and operate the crane as follows. Then, check if the display of the moment limiter is correct.

Crane operation and display item	Display value of moment limiter
Display value of "Boom length" when boom length is set at minimum	4.7m
Display value of "Boom length" when boom length is set at maximum	16.3m
Display value of "Working radius" when the boom length is set at "4.7 m" (boom one stage) and the boom angle is set at "50.0 degrees"	3.0±0.1m

4. Check that the display value of "Actual load" when a weight whose mass is known is hoisted is same as the total mass of the weight + hoisting attachment. However, some error may be generated depending on the boom condition.
5. Operate the crane and actually measure "Boom angle" and "Working radius" when making the display value of the moment limiter "4.7m" (4.7m boom) for the boom length and "50 degrees" for the boom angle. If there is any difference between the actual measurement and display value of the moment limiter, contact us or our sales service agency.

### 3.2 OPERATIONS AND CHECKS BEFORE STARTING ENGINE

#### **⚠ WARNING**

When starting the engine, check that the lock lever is securely in the lock position.

If you carelessly touch the operation levers and operation pedals at the same time as engine start, the machine may make an unexpected movement, causing serious physical injury.

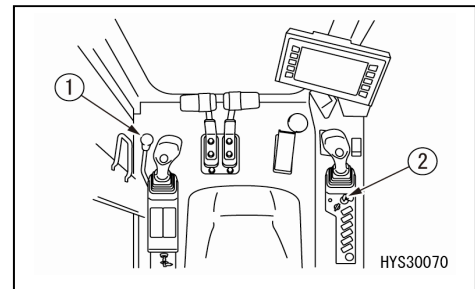

1. Check that the lock lever (1) is in the lock position (L).
2. Check that each operation lever is in the "Neutral" position. Unless each operation lever is not touched, it is in the "Neutral" position.
3. Insert the key into the starter switch (2), turn the key to the "ON" position, and check the following.

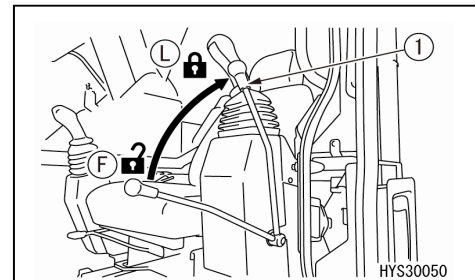

- If the password is set, the input display screen is displayed on the monitor screen. Input the password with a switch corresponding to each number. When the input is confirmed, the screen moves to the top screen. When you press and hold any switch, one character is deleted.

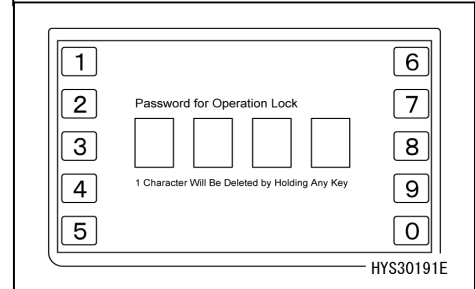
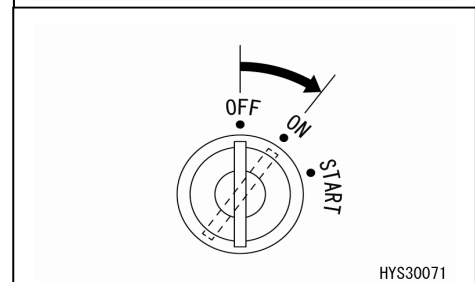

#### **NOTES**

Although the engine can be started without inputting the password, the travelling and crane operations cannot be performed.

### 3.3 STARTING ENGINE

#### **⚠ DANGER**

Never refuel (diesel fuel) while the engine is in operation.  
Always stop the engine before refilling fuel.

#### **⚠ WARNING**

- Start the engine only when the operator is sitting on the operator's seat.
- Do not start the engine by short-circuiting the starter circuit. Doing so may cause serious physical injury or fire.
- Before starting the engine, make sure no personnel or impediments are close to the machine and honk the horn.
- Exhaust gas is toxic. When starting the engine in a narrow, enclosed place, pay due attention to ventilation.

#### **CAUTION**

- If it is difficult to start the engine because the temperature is low, perform the cold climate engine starting operation.
- Do not start the engine by turning the fuel adjustment dial to near the full rotation position (MAX). Engine parts may be damaged.
- Do not keep the starter turned for more than 20 seconds. Doing so will accelerate the battery discharge.  
If the engine fail to start, wait for 2 minute before retrying.

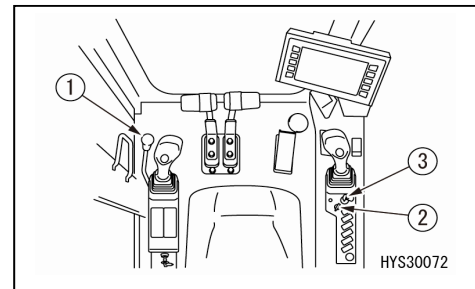

1. Check that the lock lever (1) is in the lock position (L). The engine does not start if the lock lever (1) is in the free position (F).

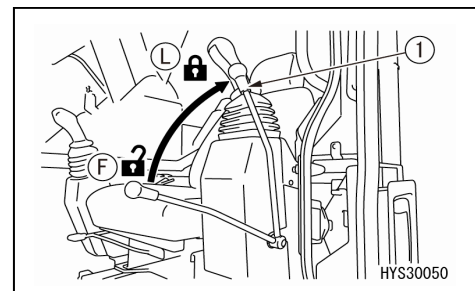

#### **NORMAL ENGINE START**

1. Turn the fuel adjustment dial (2) to the low idling position (MIN).

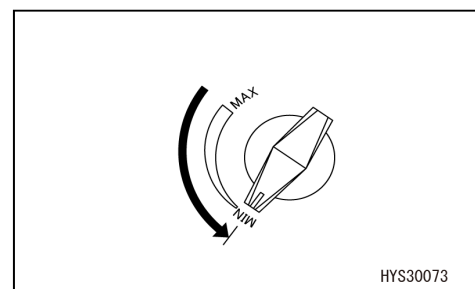



2. Insert the key into the starter switch (3) and turn the key to the "START" position. The engine starts.

3. When the engine has started, release your hand from the key.

The key automatically returns to the "ON" position.

4. Continue the idling operation for 15 seconds immediately after engine start. Do not operate the operation levers and fuel adjustment dial during this period.

**ENGINE START IN COLD CLIMATE**

1. Check, before starting the engine that the fuel adjustment dial (2) is in the low idling position (MIN).

2. Turn the fuel adjustment dial (2) to position between the low idling position (MIN) and full rotation position (MAX).

3. Insert the key into the starter switch (3), turn the key to the "ON" position and check that the auto glow lamp turns on. When preheating is completed, the auto glow lamp goes on.

4. When the auto glow lamp goes out, turn the starter switch key to the "START" position. The engine starts.

5. When the engine has started, release your hand from the key.

The key automatically returns to the "ON" position.

6. Continue the idling operation for 15 seconds immediately after engine start. Do not operate the operation levers and fuel adjustment dial during this period.

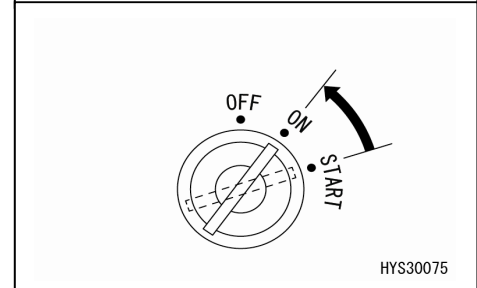
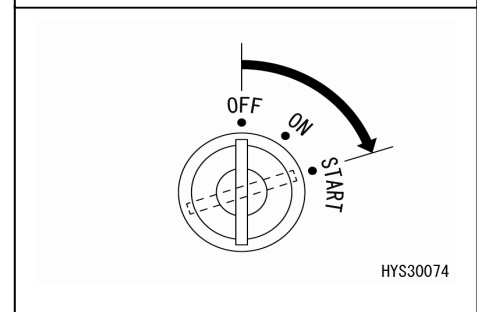
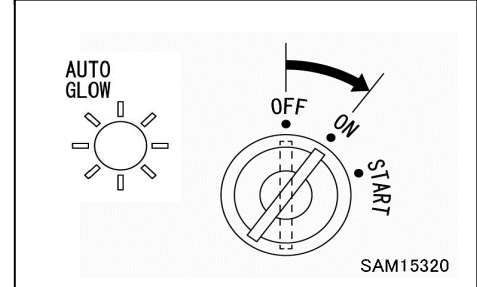
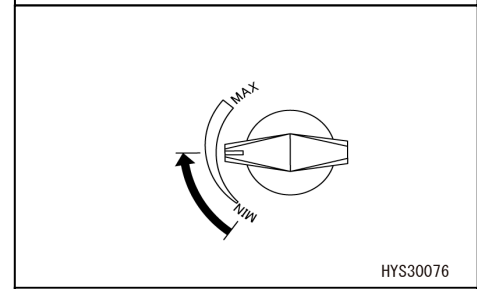
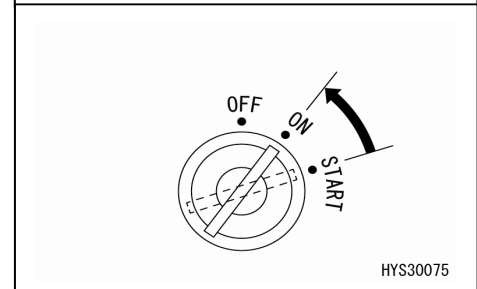
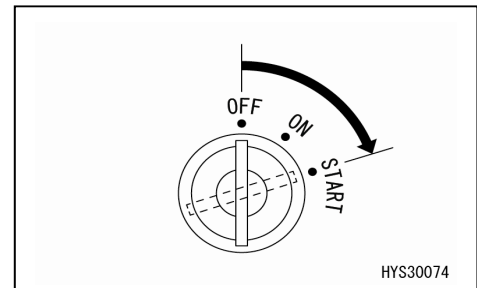



### 3.4 OPERATIONS AND CHECKS AFTER STARTING ENGINE

#### **⚠ DANGER**

**Never refuel (diesel fuel) while the engine is in operation.  
Always stop the engine before refilling fuel.**

#### **⚠ WARNING**

- **When trouble such as emergency stop and abnormal action occurs, promptly turn the starter switch to the "OFF" position and stop the engine.**
- **Do not perform work, sudden lever and pedal operations while the hydraulic oil temperature is low.  
Perform the warm-up operations of hydraulic equipment.**
- **If the machine is moved without sufficient warm-up operations of hydraulic equipment, the reaction of the machine to the operation levers and operation pedals is slow and the machine may exhibit unintended behavior to the driver.  
Be sure to perform the warm-up operations of hydraulic equipment. The hydraulic equipment needs adequate warm-up operations especially in cold climates.**

There are two types of warm-up operations: One for the engine and the other for hydraulic equipment. The method of warming-up operations differs depending on the environmental condition. Perform warm-up operations according to the respective descriptions.

The warm-up operations for the engine alone do not warm up hydraulic equipment. Perform the warm-up operations for hydraulic equipment separately from those for the engine. Performing the warm-up operations for hydraulic equipment warms up hydraulic oil, enabling warm hydraulic oil to be circulated through all the operation circuits. Be sure to perform the above.

#### 3.4.1 WARM-UP OPERATIONS FOR ENGINE

#### **CAUTION**

- **Do not accelerate the engine suddenly until the warm-up operations are done.**
- **Do not perform low idling or high idling under no load for 20 minutes or longer. Doing so adversely affects not only the environment but also the engine internal mechanism.  
When performing idling for 20 minutes or longer, apply a load sometimes or run the engine at middle speed.**

After engine start, turn the fuel adjustment dial to the idling position (MIN) and perform warm-up operations for approximately 10 minutes.

### 3.4.2 WARM-UP OPERATIONS FOR HYDRAULIC EQUIPMENT

#### ⚠ WARNING

- Before performing warm-up operations for hydraulic equipment, make sure no personnel or impediments are close to the hydraulic equipment and honk the horn.
- The warm-up operations for hydraulic equipment are necessary not only for the pump - cylinder circuits and pump-motor circuits but also for the operation circuits. Perform the cylinder and motor of not only one system and in one direction but also in all operating directions for respective operations of the crane, slewing and travelling.

1. Perform the warm-up operations for the engine.

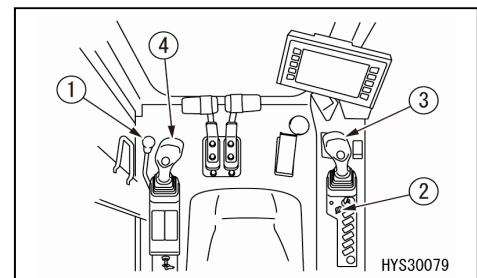

2. Place the lock lever (1) slowly in the free position (F).

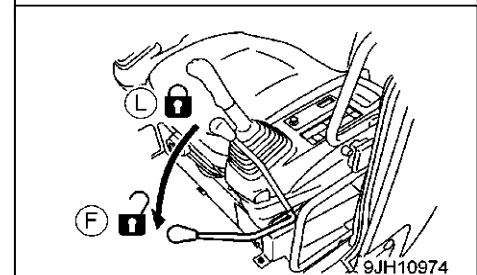

3. See "Operation 3.15 Operations Before Crane Work" and "Operation 3.16 Crane Operation Position" and prepare for crane operation.

4. Turn the fuel adjustment dial (2) to position between the low idling position (MIN) and full rotation position (MAX).

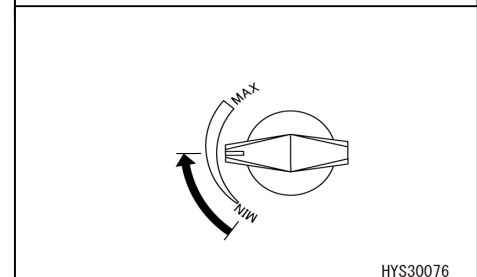

5. Slowly operate the right work equipment operation lever (3) to the stroke end on the "Lower" side (push outside) and after the boom completely lowers, hold the lever at that position for 30 seconds.

At this time, operate the right work equipment operation lever (3) to the "Wind up" side (pull backward) as necessary so that the hook does not contact the ground.

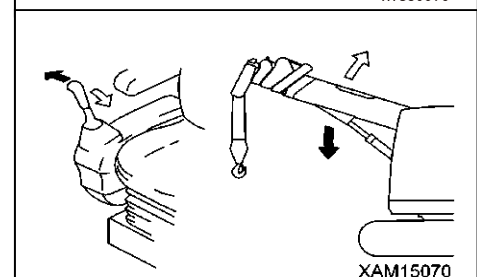

6. Slowly operate the right work equipment operation lever (3) to the stroke end on the "Raise" side (pull inside) and after the boom completely rises, hold the lever at that position for 30 seconds.

At this time, operate the right work equipment operation lever (3) to the "Wind down" side (push forward) as necessary so that the hook is not overwound.

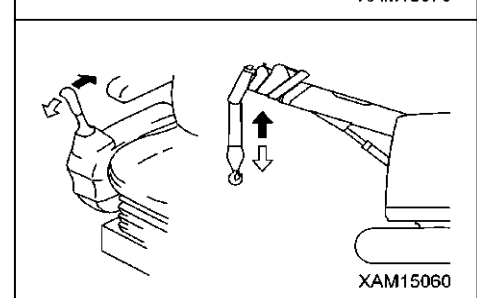



7. Slowly operate the left work equipment operation lever (4) to the stroke end on the "Extend" side (push forward) and after the boom completely extends, hold the lever at that position for 30 seconds.

At this time, operate the right work equipment operation lever (3) to the "Wind down" side (push forward) as necessary so that the hook is not overwound.

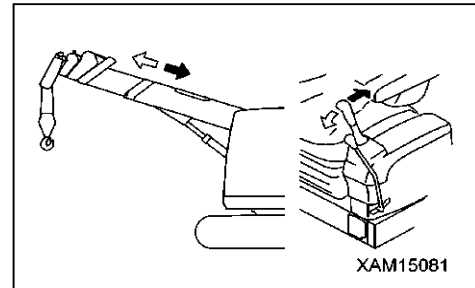

8. Slowly operate the left work equipment operation lever (4) to the stroke end on the "Retract" side (pull backward) and after the boom completely retracts, hold the lever at that position for 30 seconds.

At this time, operate the right work equipment operation lever (3) to the "Wind up" side (pull backward) as necessary so that the hook does not contact the ground.

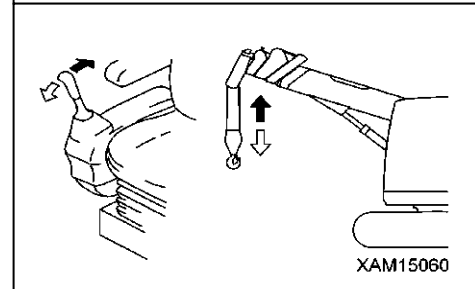

9. Repeat the operation from the procedure 7 to the procedure 10 for 5 minutes.

10. In cold climate, further repeat the operation from the procedure 7 to the procedure 10 as necessary.

### 3.5 STOPPING ENGINE

#### CAUTION

- Stopping the engine before it sufficiently cools down may shorten the life of engine units. Do not stop the engine suddenly except for an emergency.
- When the engine is overheated, do not stop the engine suddenly. Change the engine speed to low, and gradually cool down the engine before stopping.

1. Turn the fuel adjustment dial (2) to the low idling position (MIN) and continue operation under no load for approximately 5 minutes.

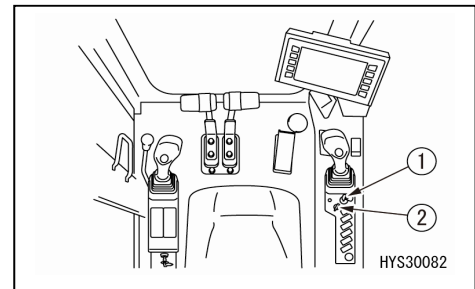

2. Turn the starter switch key (1) to the "OFF" position.  
The engine stops.

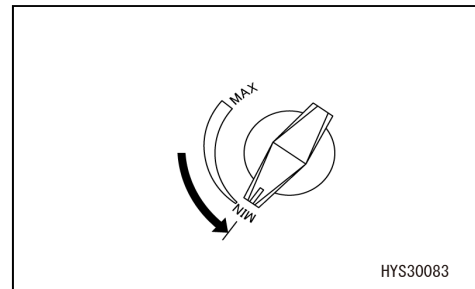

3. Remove the starter switch key (1).

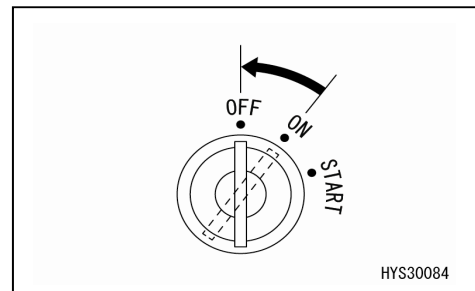

### 3.6 BREAK-IN OPERATION

#### **⚠ CAUTION**

Perform break-in period for approximately the first "100 hours" (hours displayed on the service meter).

The performance and life of the machine are adversely affected if overloaded operation or task is performed before the various sections of the machine are used to the operation.

While this machine is shipped after thorough adjustment and inspection, immediate difficult tasks will quickly degrade the functions and shorten the life of the engine and crane.

Perform break-in period for approximately the first "100 hours" (time displayed on the service meter).

Pay attention particularly to the following during the break-in period.

- Be sure to perform the warm-up operation for the engine and hydraulic equipment after the engine has started. See "Operation 3.4 Operations and Checks after Starting Engine".
- Perform the warm-up operation for 5 minutes after the engine has started.
- Avoid overloaded operation or tasks with high-speed operation.
- Avoid sudden starting, sudden acceleration, unnecessary sudden stop or sudden steering.

### 3.7 MACHINE TRAVELLING POSTURE

#### **⚠ WARNING**

- When moving this machine self-propelled, take the "travelling posture" with which the boom and hook block are stowed.
- Never travel with the boom extended or with a lifted load. Doing so may cause the machine to tip over, resulting in serious physical injury.
- Driving this machine on a public road is prohibited by the Road Traffic Law.

Take the following travelling posture when moving the machine.

#### **[1] WHEN MOVING BEFORE AND AFTER WORK/DURING TRANSPORTATION**

Take the travelling posture shown on the figure on the right when moving to the worksite or going to and from the transportation place.

- Make sure the boom is fully retracted.
- Make sure the boom is fully lowered.
- Stow the hook block in the designated stowage position (normal stowage position).
- Place the sprocket (A) to the rear.

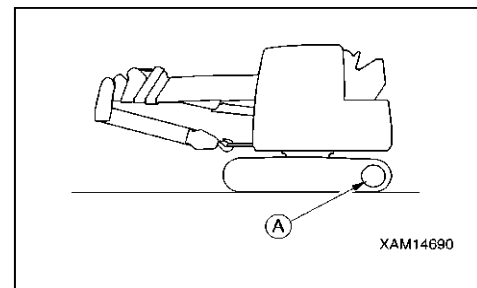

#### **[2] WHEN MOVING DURING WORK**

Take the travelling posture shown on the figure on the right when moving inside the worksite during crane operation.

- Make sure the boom is fully retracted.
- Make sure the boom is fully lowered.
- Stow the hook block in the simple stowage position at the boom tip.
- Place the sprocket (A) to the rear.

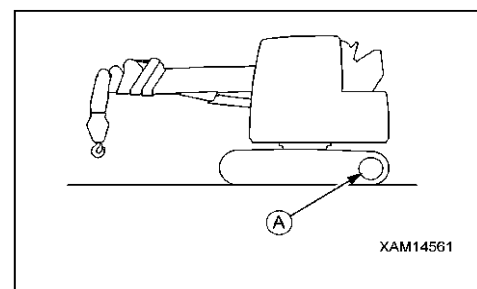

### NOTES

For details of stowage operation of the hook block, see "OPERATION 3.22 CRANE STOWAGE OPERATION".

## 3.8 STARTING (FORWARD AND BACKWARD)/STOPPING THE MACHINE

### ⚠ WARNING

- Check the direction of the track frame before operating the travelling lever. When the track frame faces backward (when the sprocket is in the front), the direction of the travelling lever operation is opposite to the direction of the machine movement.
- Do not allow anyone around the machine.
- Clear away all the obstacles on the travelling path.
- Check the safety in the vicinity of the machine and honk the horn before starting to move the machine.
- The rear of the machine body is a blind spot. Be sure to check the rear of the machine body with a rear view camera before performing backward travel operation.
- Be careful that when the travelling lever is operated during auto decel operation, engine speed suddenly increases.
- Use the accelerator pedal only when the machine stops and you operate the crane. Never use this pedal during travel operation. An operation mistake may be made, resulting in serious physical injury. Use the fuel adjustment dial to adjust engine speed during travel operation.
- Check that the travelling alarm operates properly during travelling.
- The slewing operation and boom retraction operation are possible during travelling but do not perform any crane operation. Stop the machine before performing crane operations such as slewing.

#### [Preparation for starting]

1. Turn the fuel adjustment dial (3) to the full rotation position (MAX) to increase the engine speed.

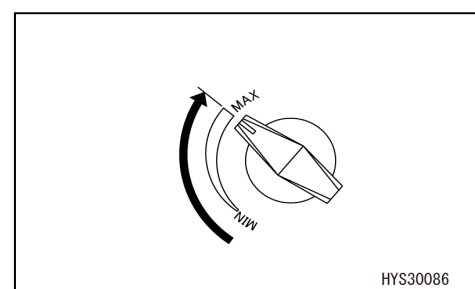
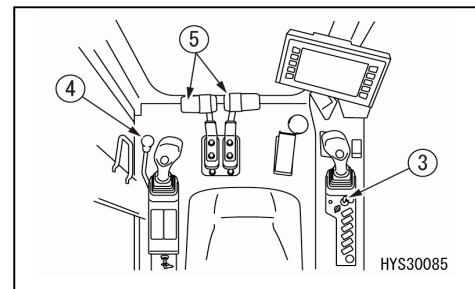

## [1] MOVING FORWARD

1. Place the lock lever (4) at the "Free" position.

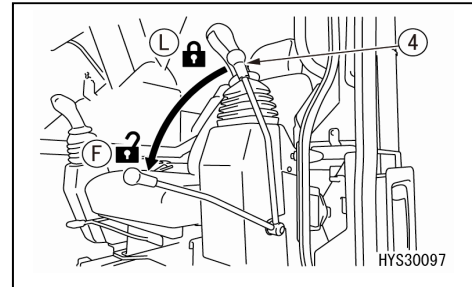

2. Operate the right and left travelling levers (5) as follows.

- When the sprocket (A) is rearward of the machine body  
Push the travelling levers (5) slowly forward to start moving.

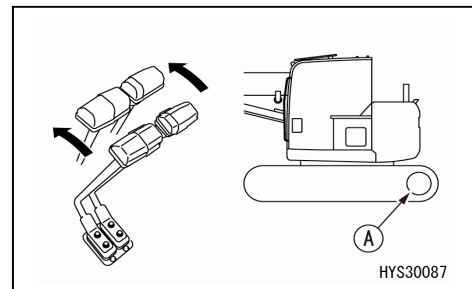

- When the sprocket (A) is forward of the machine body  
Pull the travelling levers (5) slowly toward you to start moving.

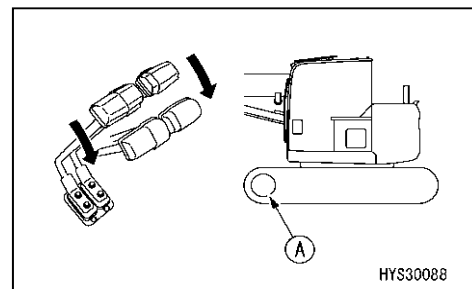

## NOTES

- Check that the travelling alarm sounds properly during travelling.  
If the travelling alarm does not sound, contact us or our sales service agency for repair.
- When the machine does not travel at proper speed at low temperature, perform sufficient warm-up operation. When the machine does not travel at proper speed because the undercarriage is clogged with sand and mud, remove sand and mud.
- When the hook block is in the simple stowage position, it may be loosened by vibration during travelling. In such a case, perform the hook block simple stowage operation again.

## [2] MOVING BACKWARD

1. Place the lock lever (4) at the "Free" position.

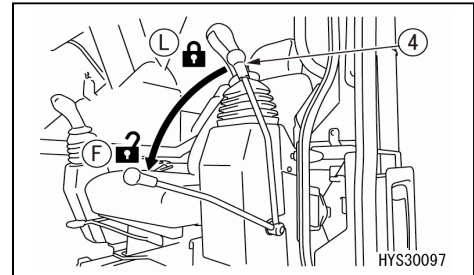

2. Operate the right and left travelling levers (5) as follows.

- When the sprocket (A) is rearward of the machine body  
Pull the travelling levers (5) slowly toward you to start moving.

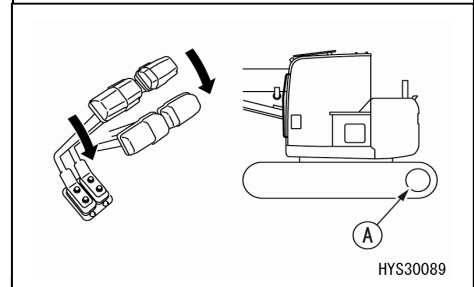

- When the sprocket (A) is forward of the machine body  
Push the travelling levers (5) slowly forward to start moving.

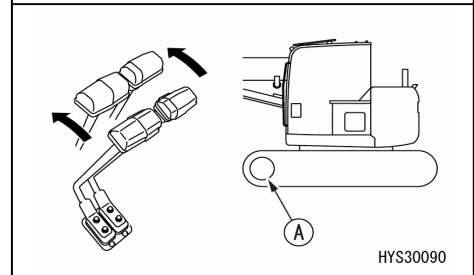

## NOTES

- Check that the travelling alarm sounds properly during travelling.  
If the travelling alarm does not sound, contact us or our sales service agency for repair.
- When the machine does not travel at proper speed at low temperature, perform sufficient warm-up operation. When the machine does not travel at proper speed because the undercarriage is clogged with sand and mud, remove sand and mud.
- When the hook block is in the simple stowage position, it may be loosened by vibration during travelling. In such a case, perform the hook block simple stowage operation again.

## [3] STOPPING

Avoid sudden stops and try to stop with a safety margin whenever possible.

- Place the right and left travelling levers (5) at the neutral position (N).  
The machine stops.

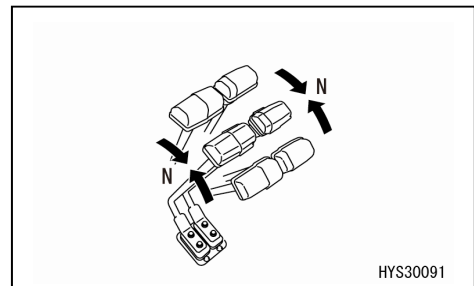

### 3.9 CHANGING DIRECTION OF THE MACHINE

#### **⚠ WARNING**

Check the direction of the track frame (position of the sprocket) before operating the travelling lever.

When the sprocket is in the front, the direction of the travelling lever operation is opposite to the direction of the machine movement.

Operate the travelling lever (1) to change the direction.  
Avoid a sudden direction change whenever possible.  
In particular, stop the machine before making a pivot turn (spin turn).  
Operate with two travelling levers (1) in the following manner.

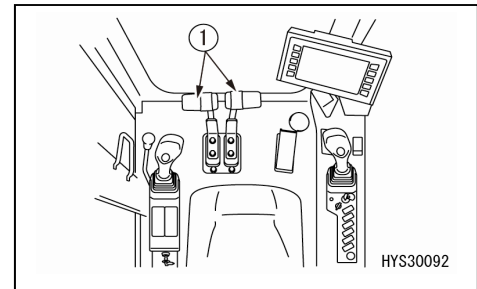

#### **[1] CHANGING MACHINE DIRECTION WHEN STOPPED**

When turning to the left, push the right travelling lever forward to turn to the left in forward movement. When pulling the lever toward you, the machine turns to the left in the backward movement.

- (A): Left turn in forward movement
- (B): Left turn in backward movement

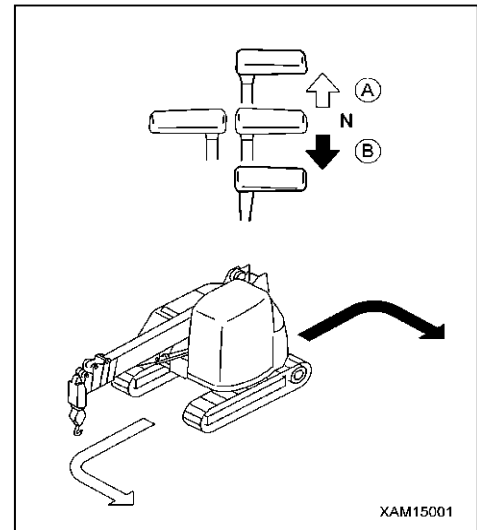

#### **NOTES**

When turning to the right, push the left travelling lever forward to turn to the right in forward movement. When pulling the lever toward you, the machine turns to the right in the backward movement.

#### **[2] CHANGING DIRECTION TO THE RIGHT OR LEFT DURING STRAIGHT FORWARD MOVEMENT**

To turn to the left, return the left travelling lever to the neutral position (N).

- (A): Left turn in forward movement
- (B): Left turn in backward movement

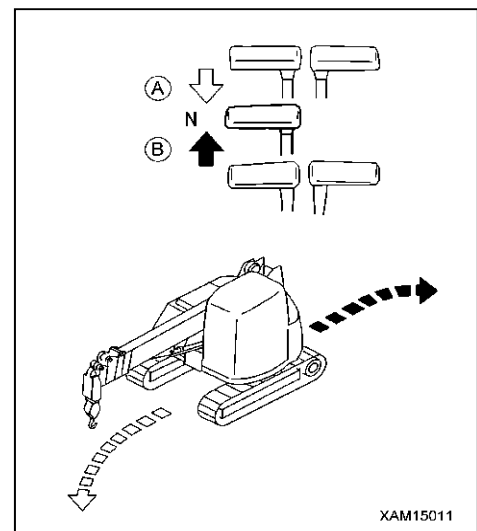

#### **NOTES**

To turn to the right, return the right travelling lever to the neutral position (N).

### [3] MAKING PIVOT TURN (SPIN TURN) ON THE SPOT

To make a pivot turn to the left, pull the left travelling lever toward you and push the right travelling lever forward.

#### NOTES

To make a pivot turn to the right, pull the right travelling lever toward you and push the left travelling lever forward.

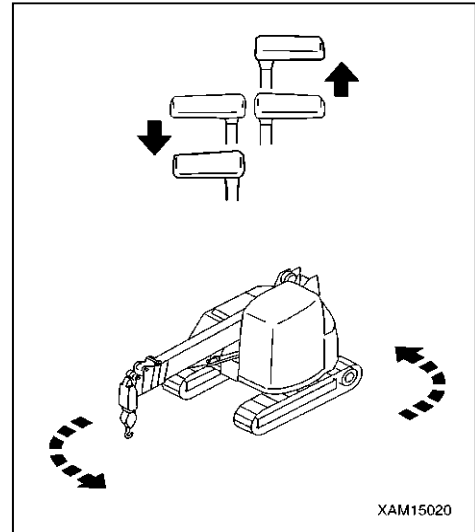

XAM15020

## 3.10 SLEWING THE MACHINE

### ⚠ WARNING

- The rear end of the machine protrudes from the crawler width. Check for safety in the vicinity with the rear view camera, mirrors and visual inspection before slewing.
- Check for safety in the vicinity of the machine and honk the horn before starting to slew the machine.
- When the lever is operated with engine speed decreased due to auto decel operation, the engine speed increases suddenly. Pay due attention when operating the lever.

1. Operate the left work equipment operation lever (1) to slew.

(A): Left slewing

(B): Right slewing

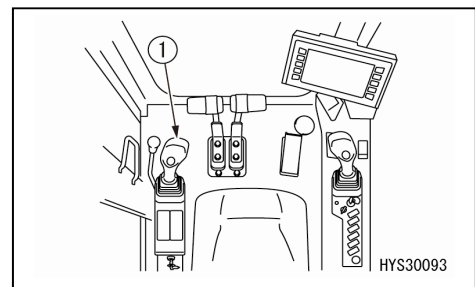

HYS30093

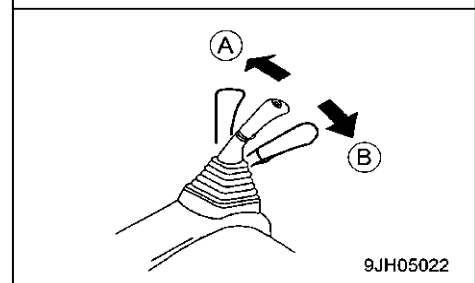

9JH05022



### 3.11 PARKING THE MACHINE

#### **⚠ WARNING**

- Choose a level and solid location for parking the machine. If it is necessary to park on a slope, provide some blocks so that the machine will not move.
  - Careless contact with the travelling lever(s) may result in sudden movement of the machine, leading to serious physical injury.
- Be sure to place the lock lever securely at the lock position before leaving the driver seat.**

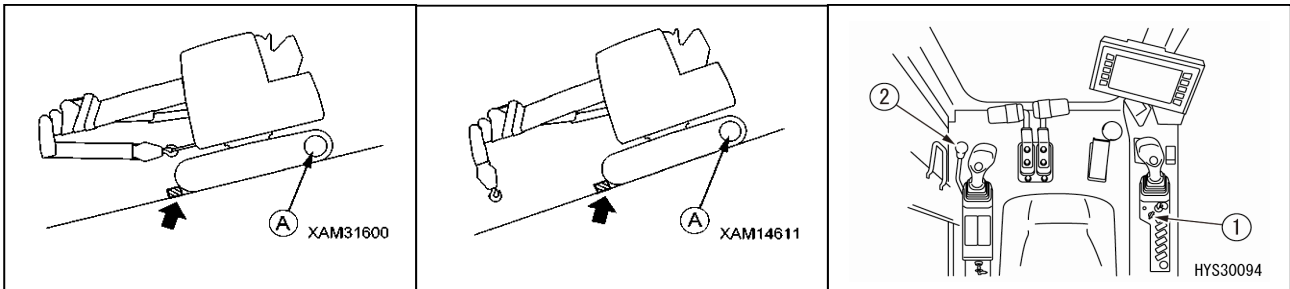

1. Stop the machine.

See "OPERATION 3.8 STARTING (FORWARD AND BACKWARD)/STOPPING THE MACHINE" for the method of stopping the machine.

2. Turn the fuel adjustment dial (1) to the low idling position (MIN) to decrease the engine speed.

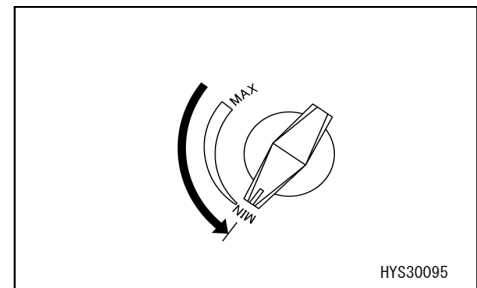

3. Turn the lock lever (2) to the lock position (L) to stop the engine.

See "OPERATION 3.5 STOPPING ENGINE" for the method of stopping the engine.

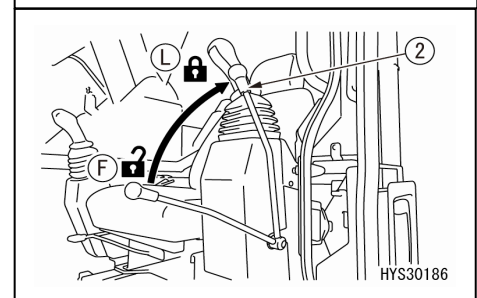



## **3.12 INSPECTION AND CHECK AFTER COMPLETING WORK**

### **3.12.1 AFTER STOPPING ENGINE**

1. Check for oil and water leaks and conduct a walk-around check of the crane, exterior and undercarriage.  
If you find any leakage or abnormality, fix the problem.
2. Fill up the fuel tank to full.
3. Remove paper and dead leaves in the engine compartment and around the battery because they may cause a fire.
4. Remove mud adhered to the undercarriage.

### **3.12.2 LOCKING**

Be sure to lock the caps and covers with lock. (2. 14 See caps and covers with lock.)

### 3.13 PRECAUTIONS IN TRAVELLING

#### **⚠ WARNING**

Unless these precautions in travelling are observed, serious physical injury may be caused.

#### [1] PRECAUTIONS IN TRAVELLING

Travelling over boulder stones or a stump can give a big impact to the machine (especially undercarriage), causing breakage.

Avoid or remove the obstacles so as not to travel over it whenever possible.

If you cannot avoid travelling over obstacles, be sure to take the "travelling posture" to lower the centre of gravity, and reduce the travelling speed as much as possible so that the machine will go over the obstacles at the centre of the crawlers.

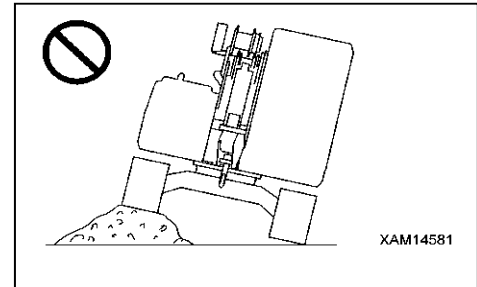

#### **NOTES**

See "OPERATION 3.7 MACHINE TRAVELLING POSTURE" for the travelling posture of the machine.

#### [2] PRECAUTIONS IN TRAVELLING AT HIGH SPEED

When travelling on a bumpy roadbed or a bumpy road with a lot of boulder stones, turn the travelling speed to the low speed "1st speed". When travelling at high speed "2nd speed" be sure to face the idler to the travelling direction.

To change the travelling speed, operate the travelling speed selector switch (1). The travelling speed (1st speed, 2nd speed) is displayed on the travelling speed monitor screen (2).

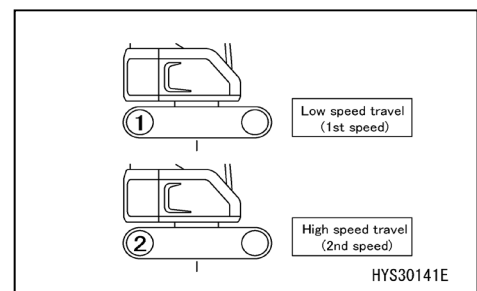

**[3] ALLOWABLE WATER DEPTH**

**⚠ CAUTION**

If the climbing posture of sharp angle of "15 degrees" or more is taken, when the machine comes out of water, the revolving super structure may be submerged in water and the engine fan may stir up water, resulting in breakage of the fan. Pay due attention when letting the machine come out of water.

Use this machine in water, only to the depth of under the center of the upper carrier roller (1).

Securely grease the lubrication points which are submerged in water for a long time until the old grease squeezes out.

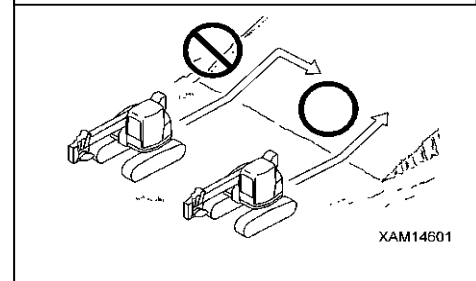
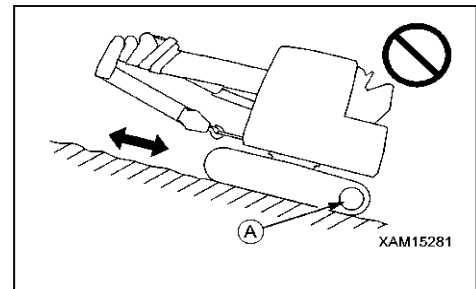
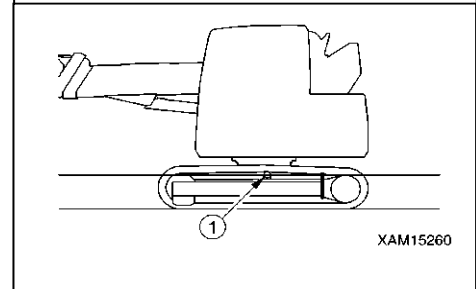
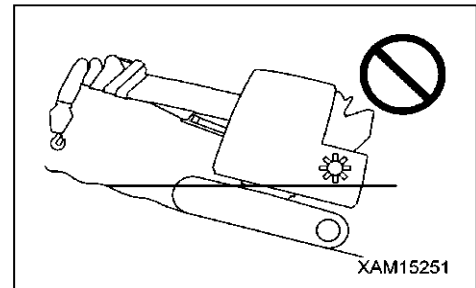

**[4] PRECAUTIONS IN TRAVELLING ON SLOPE**

**⚠ WARNING**

- Be careful of tripping and skidding when travelling over a slope.
- When the machine is inclined at 15 degrees or more by a slope, the inclination alarm operates and the buzzer sounds. When the buzzer sounds, do not travel any further and stop. Then, move to a safe place and change the direction.
- When travelling on a hill, be sure to take the travelling posture in which the hook block is stowed in the normal stowage position in the front of the revolving super structure. The hook block which is stowed in the simple stowage position at the boom tip may be loosened during travelling. See "OPERATION 3.7 MACHINE TRAVELLING POSTURE" for the travelling posture of the machine.
- On a hill the inclination of which is 10 degrees or more, travel uphill in a backward movement and travel downhill in forward movement. Always travel so that the front of the machine faces the valley side. If the machine travels uphill in forward movement and downhill in backward movement, the machine becomes unstable, resulting in danger of tipping over or side slipping.
- When travelling on a slope, face the machine perpendicular to the slant face and never change the direction or travel transversely. Practice safe travelling by for instance travelling down to the level ground and diverting.
- Always keep these conditions during running so that the Machine can stop any time when it slips or becomes unstable.

- When travelling on a steep downhill, keep down the speed using the travelling lever and fuel adjustment dial. When travelling downhill the inclination of which is 10 degrees or more, place the sprocket (A) at the downhill side and travel by decreasing the engine speed in the posture as shown in the right figure.

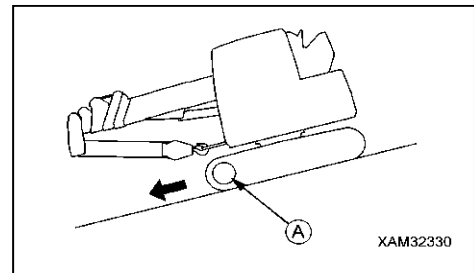

<b>NOTES</b>
Travel downhill with the sprocket (A) placed on the downhill side. If the machine travels downhill with the sprocket (A) placed on the uphill side, the crawler belt tends to be loosened, causing pitching and jumping.

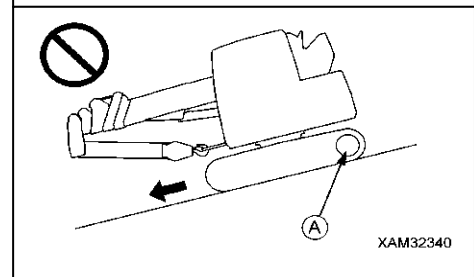

#### **[BRAKING DURING DOWNHILL TRAVELLING]**

When the travelling lever is placed at the neutral position, the brake becomes effective automatically.

#### **[WHEN ENGINE STOPS]**

When the engine stops during uphill travelling, place the travelling lever at the neutral position and stop the machine. Then, start the engine.

#### **[PRECAUTIONS ON SLOPE]**

- On a slope, when the slewing operation is performed with the left work equipment operation lever, slewing may be performed under its own weight even if the engine stops. Never perform slewing operation.
- Do not perform the opening/closing operation of the slide door during travelling on a slope. Operating force may change suddenly. Be sure to keep the slide door in a locked state.
- Pay due attention when performing the opening/closing operation of the slide door with the machine in a stopped state. The door suddenly opens/closes by the door weight, which is dangerous.

### 3.14 PRECAUTIONS BEFORE CRANE OPERATION

#### **⚠ WARNING**

**Unless these precautions before work are observed, serious physical injury may be caused.**

- Be sure to select a level place and stop the machine there before performing work.  
After stopping the machine, check the level with a spirit level.  
In the moment limiter, the moment is calculated on the assumption that the machine is placed horizontally. If work is performed without the machine being placed horizontally, no forecast or warning is issued even when the dangerous range is approached.

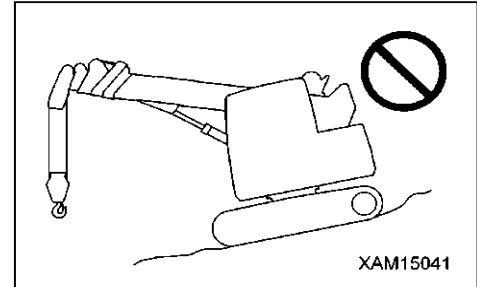

- Precisely set the moment limiter in line with the crane work. The moment limiter calculates the moment based on the set switch. If settings are different from actual work, the wire rope may be cut or the boom may be damaged, leading to serious physical injury.

**Example of erroneous settings:**

- Number of wire rope falls in actual work: Two falls
- Number of wire rope falls in set switch: Four falls

If the setting is made as shown above, the moment limiter calculated a load as a state of "wire rope four falls". Therefore, even if overload is approached, the moment limiter issues no forecast or warning.

As a result, the wire rope is in danger of being cut when the actual gross total load exceeds the range of "two falls".

- When the hook block is overhoisted, the overwinding prevention device is activated, the warning buzzer sounds and the operation stops.  
When the warning buzzer sounds, release your hand immediately from the right work equipment operation lever and place it at the neutral position to stop raising the hook.  
After that, operate the right work equipment operation lever to the "Lower" side (push forward) and lower the hook block.

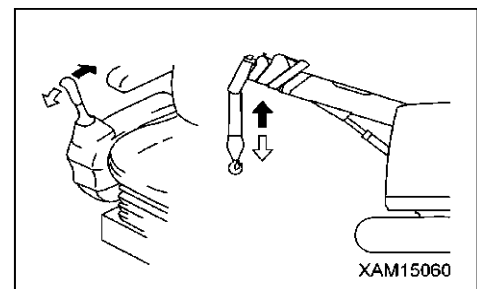



- When boom is excessively extended, the hook block is hoisted, the overwinding prevention device is activated, the warning buzzer sounds and the operation stops.  
When the warning buzzer sounds, release your hand immediately from the left work equipment operation lever and place it at the neutral position to stop the boom extension operation.  
After that, operate the left work equipment operation lever to the "Retract" side (pull toward you) to retract the boom.
- Use the horn switch to honk the horn to notify the people around of the danger during the crane operation.

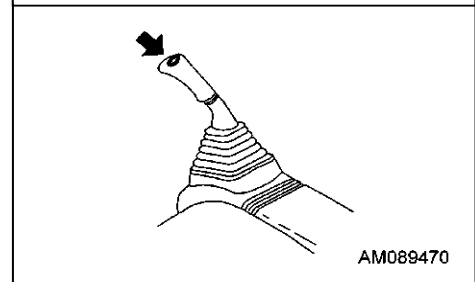
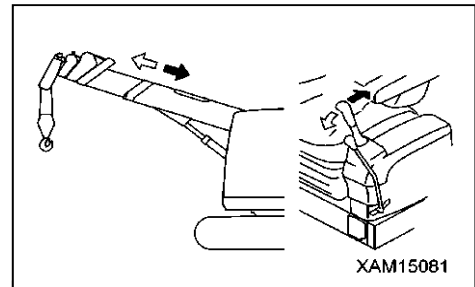

### 3.15 OPERATION BEFORE CRANE WORK

#### **⚠ CAUTION**

If the boom extending and raising operations are performed with the hook block hung on the wire rope for stowage, the wire rope for stowage is broken and the vicinity of the normal stowage device in the front of the revolving super structure is damaged. Be sure to perform the hook lowering operation so that the wire rope for stowage is not tightened.

#### **CAUTION**

- Be careful not to lower the hook block excessively so that the hook block does not fall sideways on the ground. Doing so results in irregular winding of the winch drum.
- When the hook block is loosened from the normal stowage position, the hook block may sway, interfering with and damaging the peripheral equipment. Pay due attention to the vicinity of the hook block.

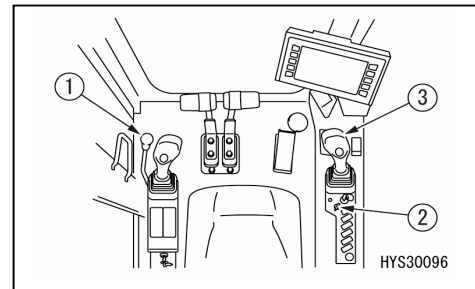

Perform the following operations before crane work.

1. Place the lock lever (1) at the "Free" position (F).

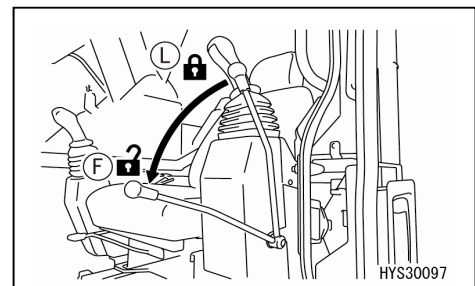

2. Turn the fuel adjustment dial (2) to the low idling position (MIN).

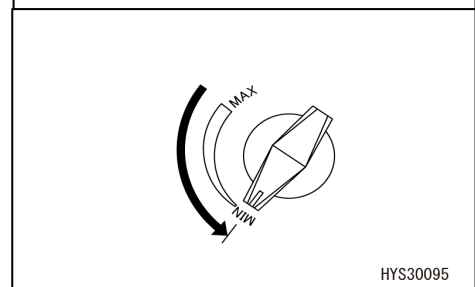

3. Operate the right work equipment operation lever (3) to the "LOWER" side (push forward) to lower the hook block (4) and loosen the rope for stowage (5) (normal stowage position).

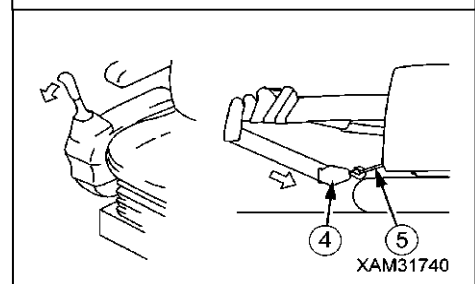

#### **NOTES**

At this time, do not lower the hook block (4) excessively. If it is excessively lowered, the loosened hook block (4) may damage the peripheral equipment.



4. Operate the right work equipment operation lever (3) to "RAISE" side (pull toward you) to raise the boom.

**NOTES**

At this time, be careful not to allow the hook block (4) and rope for stowage (5) to be overtightened. If the rope for stowage (5) is overtightened, lower the hook block (4).

5. Repeat the operation in Section 3 and 4 and slowly raise the boom until the hook block (4) is placed at the position where it is perpendicular to the stowage section in the front of the revolving super structure.

**⚠ WARNING**

If the hook block (4) is removed from the rope for stowage (5) without the boom being raised to near the stowage position, the hook block (4) sways considerably, which may not only damage to the peripheral equipment but also cause serious physical injury.

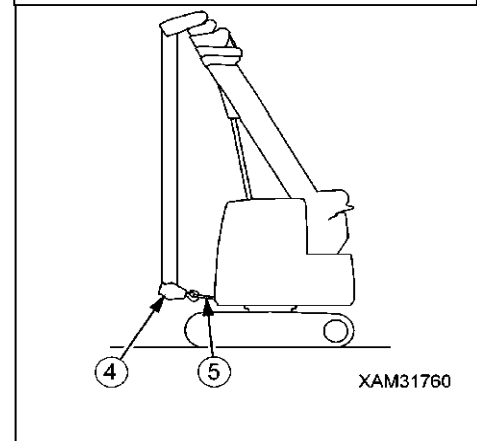
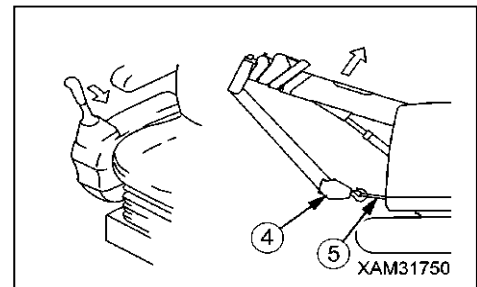

6. Remove the hook block (4) from the rope for stowage (5).

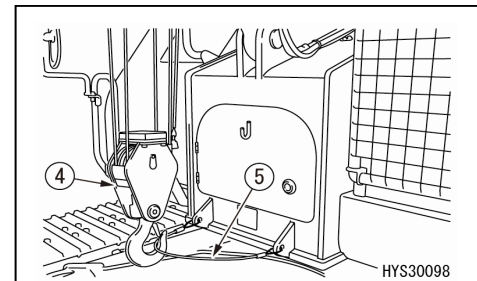

7. Securely hitch the rope for stowage (5) on the rope hook (6).

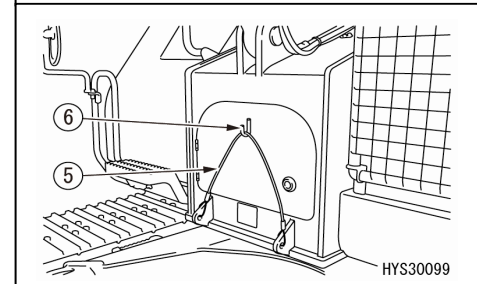

### 3.16 CRANE WORK POSTURE

When moving to the crane work from the state of "Operation 3.15 Operation Before Crane Work", put the crane into the crane work posture in the following manner.

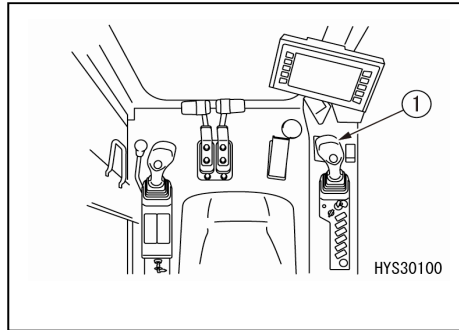

1. Operate the right work equipment operation lever (1) to the "HOIST" side (pull toward you) to hoist the hook block. At this time, do not overhoist the hook block. If overhoisted, the hook block is in a state of being overwound.

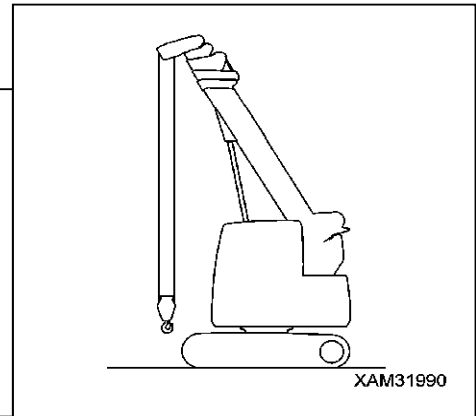

2. Operate the right work equipment operation lever (1) to "LOWER" side (push to the right side) to lower the boom. At this time, be careful not to allow the hook block to fall sideways on the ground.

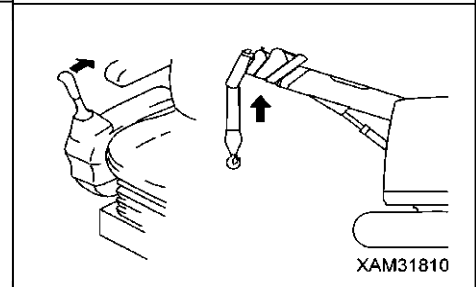

3. Repeat the operation in Section 1 and 2 and put the machine into the work posture shown in the right figure.

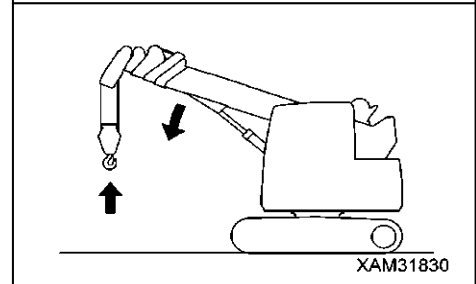
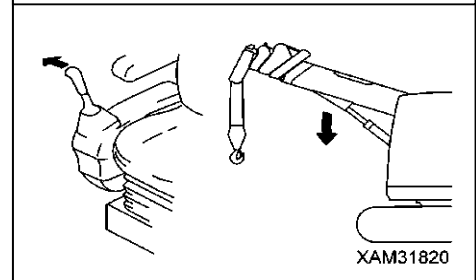

### 3.17 HOISTING AND LOWERING OPERATION

#### **⚠ WARNING**

- With the boom deflection, the hoisted load slightly shifts forward. Notify the workers around such as slinging operators.
- If the hook block is overhoisted, the overwinding prevention device detects overwinding and the warning buzzer sounds intermittently. When the buzzer sounds, immediately operate the right work equipment operation lever to the neutral position to stop the hoisting operation.
- When lowering the hook for long distance for underground works, be sure to leave more than 3 turns of the wire rope on the winch drum.

#### **CAUTION**

- Be careful not to lower the hook block excessively so that the hook block does not fall sideways on the ground. Doing so results in irregular winding of the winch drum.
- When stopping the winch operation, do not suddenly return the lever to the neutral position. Doing so may loosen the wire rope, resulting in irregular winding of the winch drum.

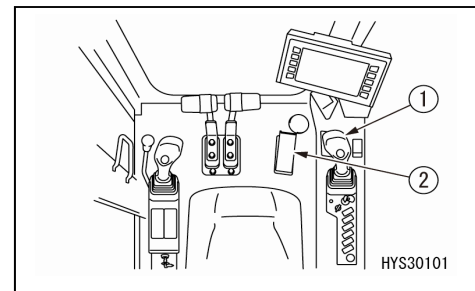

#### 3.17.1 NORMAL HOISTING AND LOWERING OPERATION

Operate the right work equipment operation lever (1) as follows.

- Lowering: Push the lever forward.
- Neutral: Release your hand from the lever.  
The lever will return to the neutral position and the raising/lowering of the hook block stops.
- Hoisting: Pull the lever toward you.

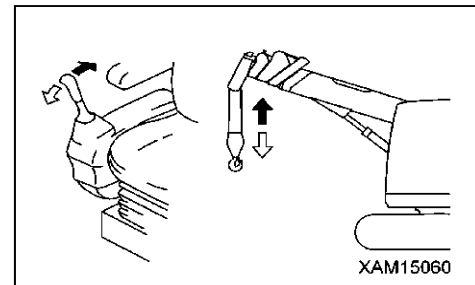

#### **NOTES**

Adjust the winch raising and lowering speed by the stroke of the right work equipment operation lever (1) and the depression amount of the accelerator pedal (2).

### 3.17.2 HOISTING AND LOWERING OPERATION AT HIGH SPEED

#### ⚠ WARNING

- Perform high-speed winch operation only in a state of no load without lifting a load. The winch operation of a hoisted load at high speed may cause serious physical injury due to machine tipping and breakage or dropping of a load.
- If a load of hoisted load is "0.5t" or more, the speed does not become high even when the winch 2 speed selector switch is turned to the "High speed". If a load of hoisted load is "0.2t" or less, it is possible to perform the winch operation at high, but such operation may cause serious physical injury due to machine tipping and breakage or dropping of a load. Therefore, avoid such operation as much as possible.

#### NOTES

- When the boom is raised or lowered, the numerical value of an actual load of the moment limiter changes slightly due to a change of pressure of the derrick cylinder. If the numerical value of an actual load of the moment limiter is "0.5t" or more, the speed does not become high even when the winch 2 speed selector switch is turned to the "High speed".
- When "One fall" is selected for the number of wire falls of the moment limiter, the speed does not become high even when the winch 2 speed selector switch is turned to the "High speed" (the lamp of the switch part turns on). The speed is fixed to low speed.

Operate the winch 2 speed selector switch of the left work equipment operation lever.

- High speed: Press the switch. (2) is displayed on the winch speed display of the monitor. Raising and lowering speed is increased.
- Low speed: Press the switch again. (1) is displayed on the winch speed display of the monitor. The speed returns to the normal raising and lowering speed.

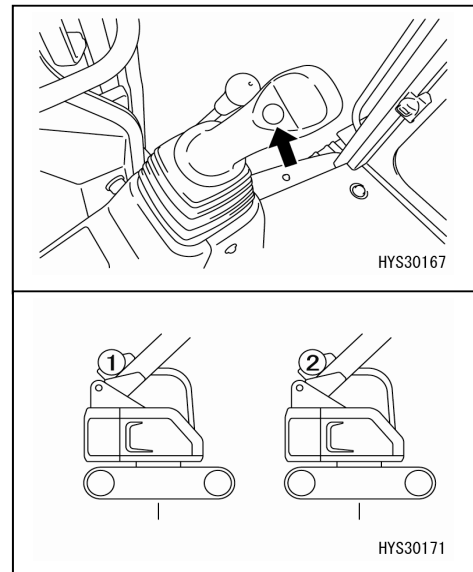

### 3.17.3 HOISTING OPERATION WITH HOOK STORAGE SWITCH

#### **⚠ WARNING**

- The hook storage switch cancels the automatic stop function of the overwinding prevention device.  
When storing the hook block, carefully operate the right work equipment operation lever and pay due attention not to allow the hook block to crash against the boom.
- Use the hook storage switch only when performing simple storage of the hook block in the boom tip.

While performing the normal hoisting operation, operate the hook storage switch of the monitor as follows.

- **Cancel :** While continuing to press the switch, operate the right work equipment operation lever to the "Hoisting" side (pull toward you). The hook block is hoisted and is stored in the storage section of the boom tip.  
At this time, the lamp of the switch part turns on.
- **Automatic:** Release your finger from the switch. The switch returns to the original position, and the automatic stop function of the overwinding prevention device turns into an operating state.

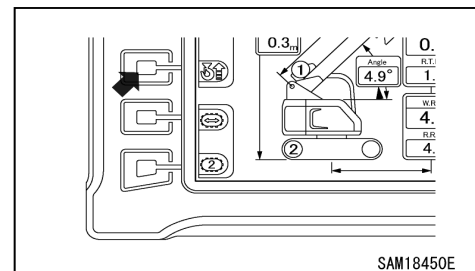

SAM18450E

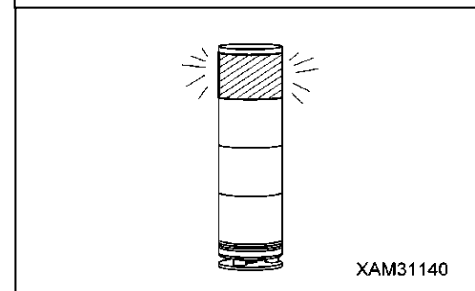

XAM31140

#### **NOTES**

- When this hook storage switch is placed at the "Cancel" position, the red lamp of the rotating warning lamp turns on.
- When the winch is hoisted while the hook storage switch is pressed, the hoisting speed becomes slow, which is not a fault.

### [MIRROR FOR CHECKING WINCH DRUM IRREGULAR WINDING]

#### **CAUTION**

The irregular winding check mirror (1) is installed in the lower part of the winch drum so that if irregular winding of the wire rope happens at the winch drum, it can be easily checked from the driver seat.

When performing the wire rope hoisting operation, check the presence/absence of irregular winding by taking a close look.

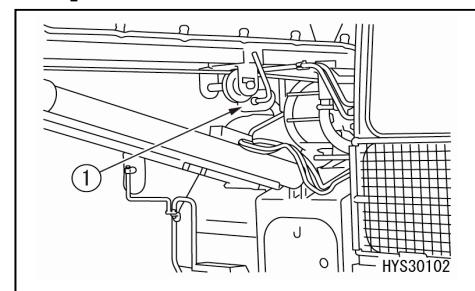

HYS30102

### 3.18 BOOM DERRICKING OPERATION

#### **⚠ WARNING**

- Perform the right work equipment operation lever operation as slowly as possible. Especially avoid sudden lever operations when the load is hoisted, which may cause the load to waggle and give a large impact to the machine, and thus may damage the crane or tip the machine.
- Pulling-in and raising work of a load by derricking the boom is prohibited. Be sure to perform the hook hoisting operation to lift a load.
- When the boom is lowered, the working radius increases, and the rated total load that can be hoisted decreases. When operating by derricking the boom, pay extra attention so that the mass (weight) of the load at the time the boom is most lowered does not cause overloading.

Operate the right work equipment operation lever (1) as follows.

- Lowering: Push the lever outside (right side).
- Neutral: Release your hand from the lever.  
The lever returns to the neutral position and the boom derricking stops.
- Raising: Pull the lever inside (left side).

#### **NOTES**

- Adjust the boom derricking speed by the stroke of the right work equipment operation lever (1) and depression amount of the accelerator pedal (2).
- When the boom length display of the moment limiter display is "5.3m" or longer, the lowering action stops automatically so that the boom angle does not fall below the level.

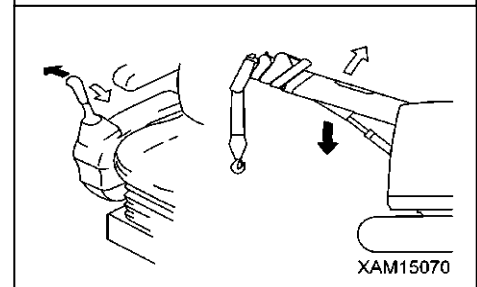
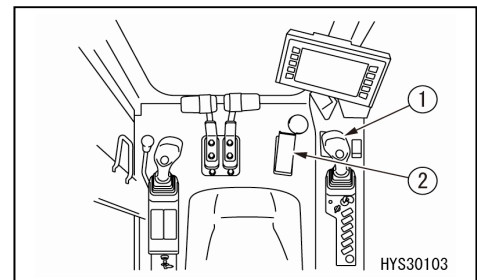

### 3.19 BOOM TELESCOPING OPERATION

#### ⚠ WARNING

- Perform the left work equipment operation lever operation as slowly as possible. Especially avoid sudden lever operations when the load is hoisted, which may cause the load to waggle and give a large impact to the Machine, and thus may damage the crane or tip the Machine.
- Pulling of the load laterally by extending/retracting the boom is prohibited. Be sure to perform the hook hoisting operation to lift a load.
- When the boom is extended, the working radius increases, and the rated total load that can be hoisted decreases. When working while extending/retracting the boom, pay extra attention so that the mass (weight) of the load at the time the boom is most extended does not cause overloading.
- When the boom is extended, the hook block is raised. If the warning buzzer of the overwinding detector sounds during the boom extending operation, return the boom telescoping lever immediately to the neutral position and stop the boom extending operation.

#### CAUTION

- When the boom is extended/ retracted, the hook block is in a raised or lowered state. Always perform the winch operation simultaneously to adjust the hook block height.
- When the boom is extended for a long time, the boom slightly retracts due to the temperature change in the hydraulic oil. In this case, extend the boom as needed.

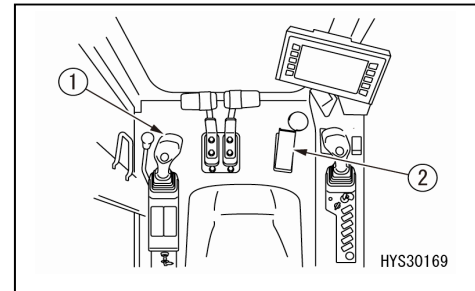

Operate the left work equipment operation lever (1) as follows.

- Extend: Push the lever forward.  
The lever returns to the neutral position and the boom extension/retraction stops.
- Neutral: Release your hand from the lever.
- Retract: Pull the lever toward you.

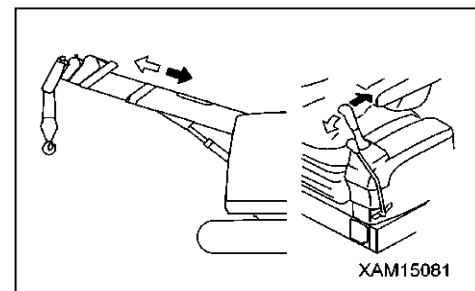

#### NOTES

- Adjust the boom extending/retracting speed by the stroke of the left work equipment operation lever (1) and depression amount of the accelerator pedal (2).
- When the boom extends, the second stage extends first, then the third stage and finally the fourth and fifth stages extend simultaneously. When the boom retracts, it retracts in the reverse order of extension.



### CAUTION

When the boom extends and the hook block (3) pushes up the weight (5) of the overwinding detector (4), the boom extension stops. In this state, the boom does not extend when the boom extending operation is performed.

In such a case, lower the hook block by performing the retracting operation or the lowering operation of the boom.

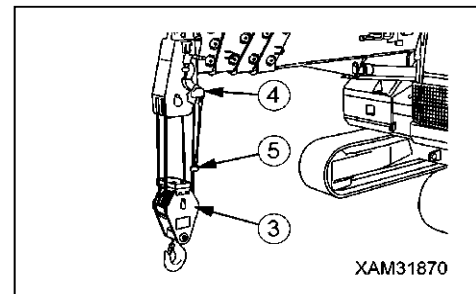



### 3.20 SLEWING OPERATION

#### **⚠ WARNING**

- Check for safety in the vicinity and honk the horn before slewing.
- Perform the slewing operation as slowly as possible. Make sure to start smoothly, slew at low speed, and stop quietly. Especially avoid sudden lever operations when the load is hoisted, which may cause the load to waggle and cause the machine to lose balance, and thus may damage the crane or tip the machine.
- Pulling-in and raising work of a load by performing the slewing operation is prohibited. Be sure to perform the hook hoisting operation to lift a load.

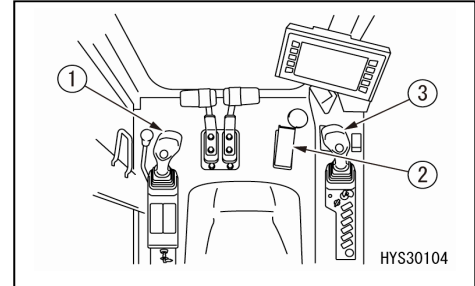

Operate the left work equipment operation lever (1) as follows.

- Left slewing: Push the lever outside (left side).
- Neutral: Release your hand from the lever.

The lever returns to the neutral position and the slewing stops.

- Right slewing: Pull the lever inside (right side).

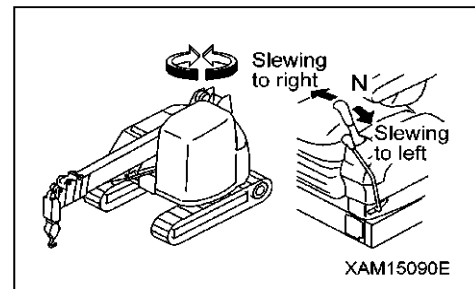

#### **NOTES**

- Adjust the crane slewing speed by the stroke of the left work equipment operation lever (1) and depression amount of the accelerator pedal (2).
- There is a horn switch (3) in the center of the knob of the right work equipment operation lever. Use the switch to give a signal when performing the slewing operation.

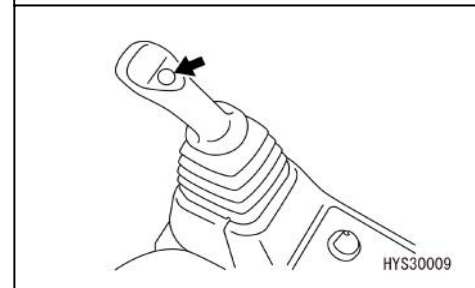

#### **CAUTION**

The gross rated load is the same in all directions regardless of the slewing stop position.

### 3.21 ACCELERATOR OPERATION

#### ⚠ WARNING

- Accelerating the operation speed of the crane units more than necessary is dangerous. Adjust the speed to the proper working speed suitable to the work.
- Use the accelerator pedal only when the machine stops and you operate the crane. Never use this pedal during travelling with a lifted load. An operation mistake may be made, resulting in serious physical injury.

#### CAUTION

- Decrease the speed at the beginning and near the end of an operation. Change the speed to low or high according to the load.
- As a priority is given to the engine speed of the fuel adjustment dial, the engine speed does not fall below the set speed of the fuel adjustment dial even if you release your foot from the accelerator pedal. When performing work using the accelerator pedal, operate the fuel adjustment dial in advance to set the necessary minimum engine speed.

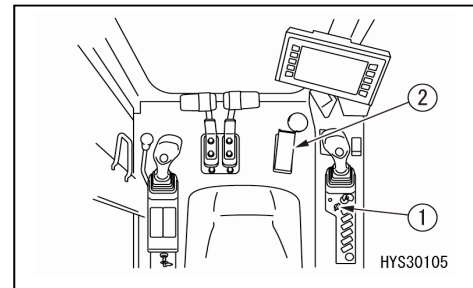

Use both the fuel adjustment dial (1) and the accelerator pedal (2) to adjust the working speed.

#### [1] WHEN WORKING AT CONSTANT WORKING SPEED

Adjust the fuel adjustment dial (1) to the working speed suitable to the work.

- (a) Low idling (MIN): Position where the dial is fully turned counterclockwise (left direction)
- (b) Full revolution (MAX): Position where the dial is turned clockwise (right direction)

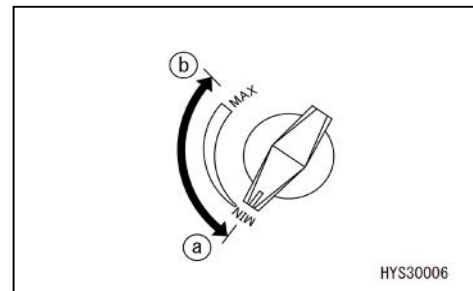

#### [2] WHEN WORKING AT FLUCTUATING WORKING SPEED

1. Adjust the fuel adjustment dial (1) to the minimum working speed suitable to the work.
2. Increase or decrease the depression amount of the accelerator pedal (2) to the working speed according to the load.

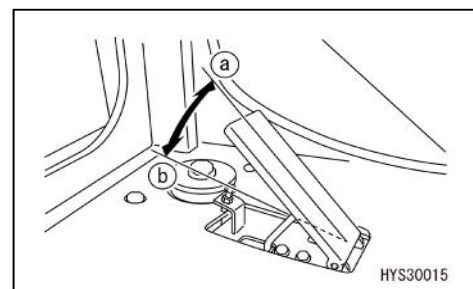



- (a) Low idling: Release your foot from the pedal.  
The engine speed decreases and the working speed of the crane parts becomes slow. At this time, the speed turns to the minimum working speed adjusted by the fuel adjustment dial (1).
- (b) Full revolution: Depress the pedal.  
The engine speed increases and the working speed of the crane parts become fast.

<b>NOTES</b>
Perform work by depressing the pedal to the engine speed position necessary for the work.

## 3.22 CRANE STOWAGE OPERATION

### 3.22.1 CRANE STOWAGE OPERATION AT THE TIME OF SIMPLE STOWAGE OF HOOK BLOCK

#### **⚠ CAUTION**

- The hook storage switch cancels the automatic stop function of the overwinding prevention device.  
When storing the hook block, carefully operate the right work equipment operation lever and pay due attention not to allow the hook block to crash against the stowage position at the boom tip.
- Move by storing the hook block in the simple stowage position only when moving inside the worksite a short distance between crane operations. When moving a long distance such as when moving to the worksite or going to and from the transportation place, store the hook block in the normal stowage position in the front of the revolving super structure.
- When storing the hook, be sure to make the boom is level before performing the stowage operation. If the hook is stored with the boom raised up, the rubber on the upper part of the hook block can be broken.
- Do not raise or lower the boom with the hook stored. The rubber on the upper part of the hook block can be broken.
- Do not turn the override switch to the "ON" position when performing the hook stowage operation. Doing so does not bring the mode into the hook stowage mode, and the rubber, boom and wire rope on the upper part of the hook block may be broken.

#### **CAUTION**

- Stop the sway of the hook block before storing the hook block in the simple stowage position.
- Be careful not to lower the hook block excessively so that the hook block does not fall sideways on the ground. Doing so results in irregular winding of the winch drum.
- The boom "Retracting" operation will lower the hook block. The hook block also lowers with the boom "Lowering" operation. Perform the hoisting operation simultaneously so that the hook block does not fall sideways on the ground.
- Perform the hoisting operation slowly and do not perform the hook block stowage operation with high-speed hoisting of the winch.

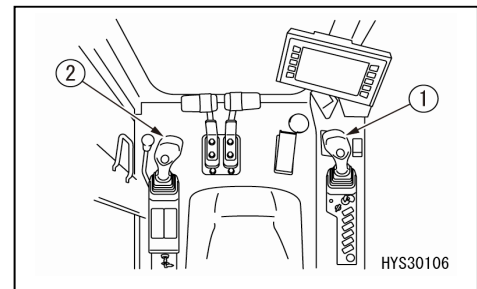



1. Operate the left work equipment operation lever (2) to the "Retract" side (pull toward you) to retract the boom fully.

<b>NOTES</b>
The hook block lowers with the boom retracting operation. Perform the hoisting operation as appropriate and hoist the hook block.

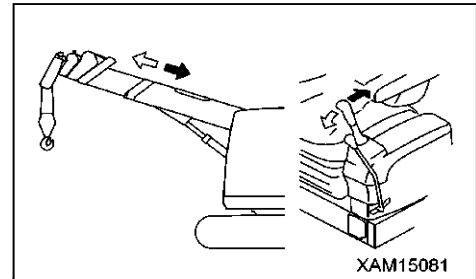

2. Operate the right work equipment operation lever (1) to "Lower" side (push it outside) to lower the boom until it stops.

<b>NOTES</b>
The hook block lowers with the boom lowering operation. Perform the hoisting operation as appropriate and hoist the hook block.

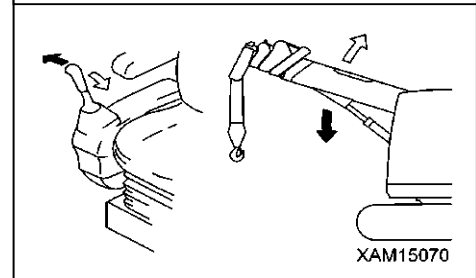

3. Each time the hook block lowers and nears the ground with the operation in Sections 1 and 2, operate the right work equipment operation lever (1) to the "Hoisting" side (pull toward you) and hoist the hook block to the extent that it is not overwound.

<b>NOTES</b>
If the hook block is overhoisted, overwinding is detected, the warning buzzer sounds, and the hoisting operation stops automatically.

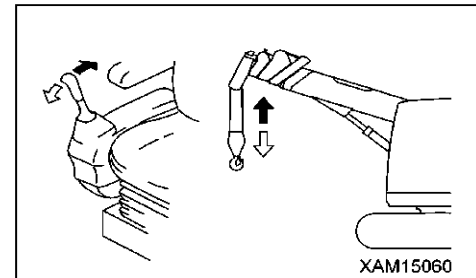

4. Operate the left work equipment operation lever (2) to the "Left slewing" side (push outside) or to the "Right slewing" side (pull inside) and slew so that the boom is positioned in the center of the machine body.

<b>NOTES</b>
The boom stowage is completed with the operation of Section 1 to Section 4. Store the hook block (3) in the simple stowage position with the operation described in the following sections.

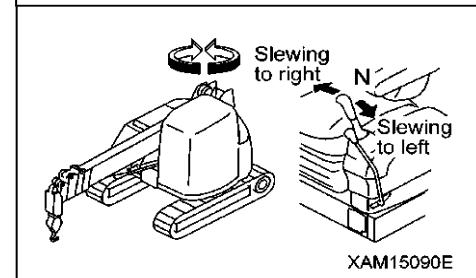

5. Operate the right work equipment operation lever (1) to the "Hoisting" side (pull toward you) and hoist the hook block (3) until it pushes up the weight (4) and stops automatically (a state of overwinding).

<b>NOTES</b>
When the hook block (3) is overhoisted, the warning buzzer sounds and the hoisting operation stops automatically.

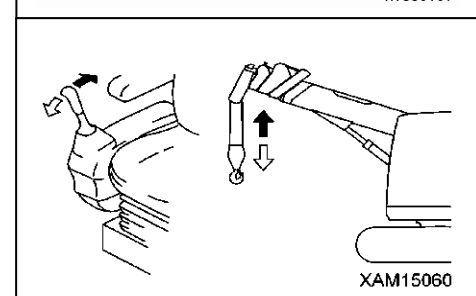
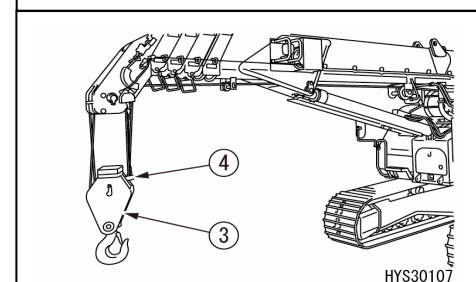



6. While pressing the hook stowage switch, operate the right work equipment operation lever (1) to the "Hoisting" side (pull toward you) again and slowly and carefully hoist the hook block (3) to store it in the lower part of the boom tip.

**NOTES**

- When the hook stowage switch is pressed, the red lamp of the rotating warning lamp turns on.
- When the winch is hoisted while the hook stowage switch is pressed, the hoisting speed becomes slow, which is not a fault.

**NOTES**

The right figure shows a state in which the hook block (3) is stored in the lower part of the boom tip.

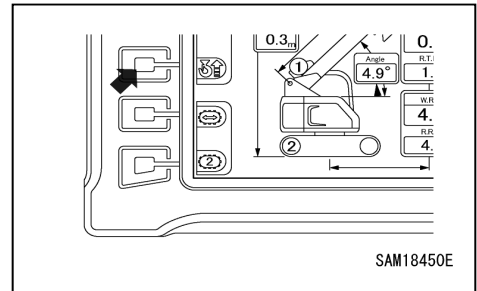

SAM18450E

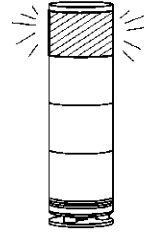

XAM31140

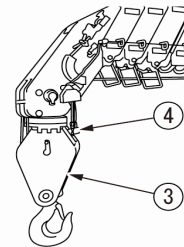

HYS30108

### 3.22.2 CRANE STORAGE OPERATION AT THE TIME OF NORMAL STORAGE OF HOOK BLOCK

#### ⚠ WARNING

- When storing the hook block, carefully operate the right and left work equipment operation levers. Otherwise, the hook block may sway considerably, not only damaging the peripheral equipment but also causing serious physical injury.
- Raise the boom to near the hook block stowage position. If the hook block is away from the stowage position, the hook block may come off, not only damaging the peripheral equipment but also causing serious physical injury, when the hook block is going to be hung on the rope for stowage.

#### CAUTION

- Stop the sway of the hook block before storing the hook block in the simple stowage position.
- Be careful not to lower the hook block excessively so that the hook block does not fall sideways on the ground. Doing so results in irregular winding of the winch drum.
- The boom "Retracting" operation will lower the hook block. The hook block also lowers with the boom "Lowering" operation. Perform the hoisting operation simultaneously so that the hook block does not fall sideways on the ground.

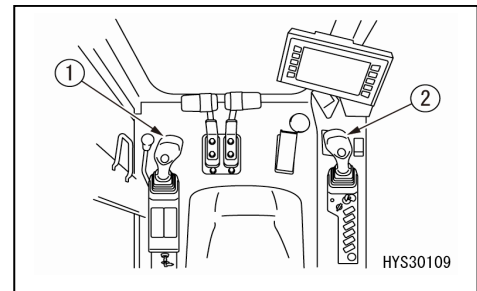

1. Operate the left work equipment operation lever (1) to the "Retract" side (pull toward you) to retract the boom fully.

#### NOTES

The hook block lowers with the boom retracting operation. Perform the hoisting operation as appropriate and hoist the hook block.

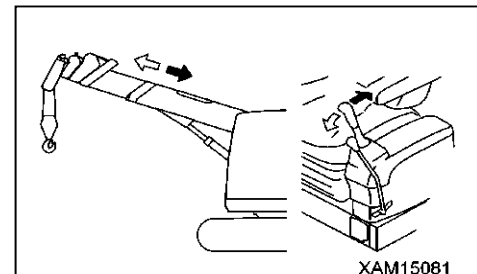

2. Operate the right work equipment operation lever (2) to the "Raise" side (pull inside) and raise the boom up to the position where the hook block nears the normal stowage position.

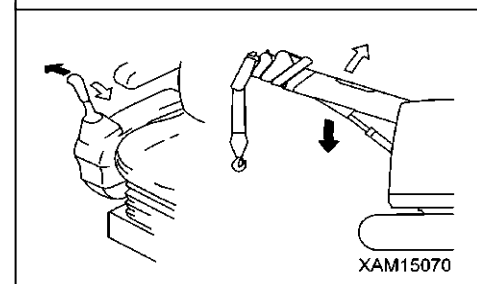

3. Operate the right work equipment operation lever (2) to the "Lower" side (push forward) and lower the hook block to near the normal stowage position.

**NOTES**

At this time, do not lower the hook block (3) excessively. If it is excessively lowered, the loosened hook block (3) may damage the peripheral equipment.

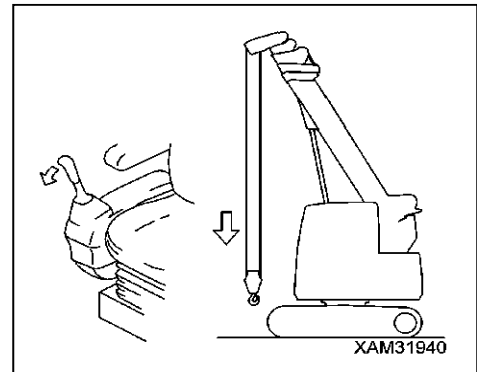

4. Remove the rope for stowage (4) from the rope hook (5).

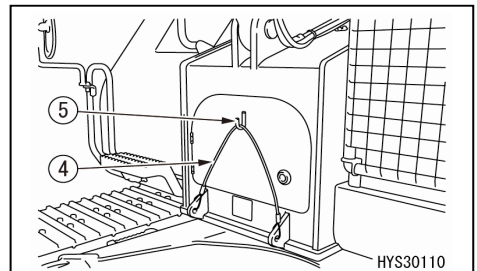

5. Hang the rope for stowage (4) on the hook block (3).

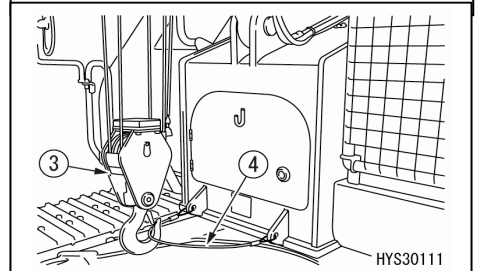

6. Operate the right work equipment operation lever (2) to "Lower" side (push outside) to lower the boom to the end.

**NOTES**

At this time, hoist the hook block (3) occasionally to reduce slack in the wire rope. At this time, be careful not to allow the hook block (3) and rope for stowage (4) to be overtightened.

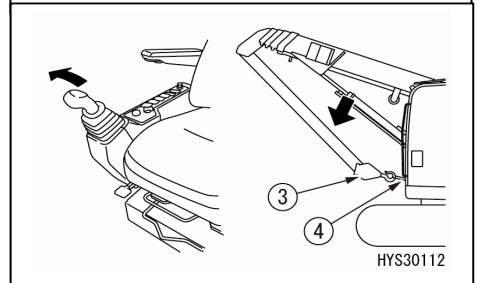

7. Operate the right work equipment operation lever (2) to the "Hoist" side (pull toward you) to hoist the hook block and tighten the rope for stowage (5).

**NOTES**

At this time, do not overhoist the hook block (3). If it is overhoisted, the rope for stowage (4) may cause damage the vicinity of the normal stowage position at the front of the revolving super structure.

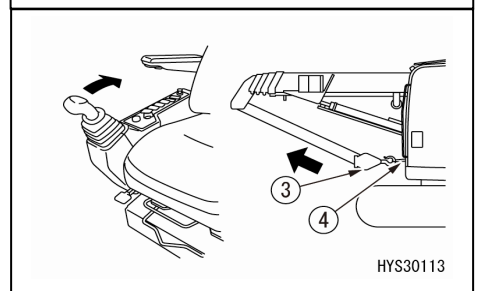



### 3.23 PROHIBITED OPERATIONS DURING CRANE WORK

#### **⚠ WARNING**

- Always set the machine on level, solid ground when performing the crane operations. Check the level state using a levelling instrument.
- Even when the crane must be unavoidably operated during travelling, be sure to stop the machine once before operating it. Even if the right and left work equipment operation levers are operated during travelling, this machine performs no operation other than the slewing operation and boom retracting operation.
- See the cautions given in the "Safety" besides the do's and don'ts in this section.

#### **[1] DON'T OPERATE USING SLEWING FORCE**

Drawing in or lifting the load with slewing operation is prohibited.

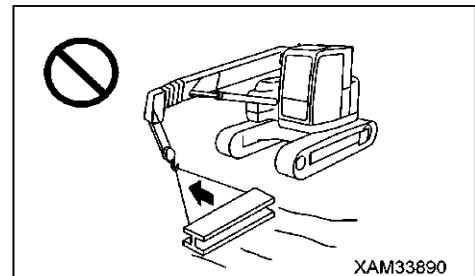

#### **[2] DON'T OPERATE USING DERRICKING FORCE**

Drawing in or lifting the load with boom derricking operation is prohibited.

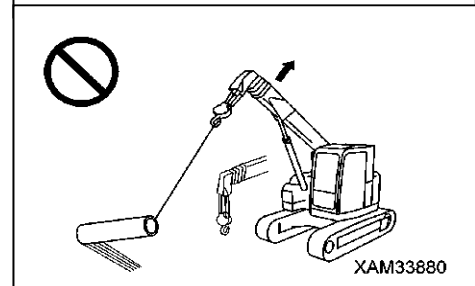

#### **[3] DON'T PULL SIDEWARD, DRAW IN OR HOIST DIAGONALLY**

Pulling the load sideways, drawing it in, or hoisting diagonally applies unreasonable force on the machine. It not only damages the machine body, but also is dangerous. Never operate in this way.

The hook must lift right above the centre of gravity of the load hoisted.

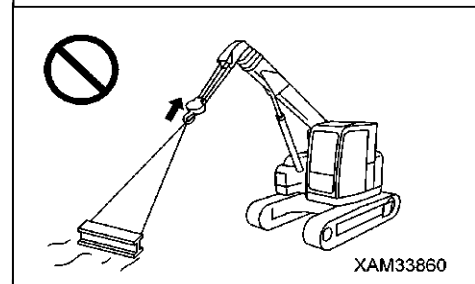

#### **[4] DON'T OPERATE VIOLENTLY DURING WORK**

Do not operate the levers suddenly.

Especially, "slewing", "boom lowering", and "hook lowering" must be operated at low speeds.

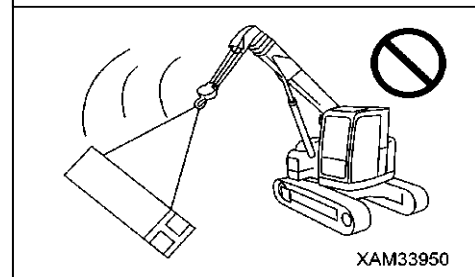



**[5] DON'T ALLOW ACCESS INTO WORKING RADIUS**

Do not allow personnel to approach the working radius such as letting operators enter under a hoisted load.

**[6] DON'T USE FOR OTHER THAN MAIN APPLICATIONS**

Do not move people up/down with the crane.

**[7] DON'T PERFORM UNREASONABLE OPERATIONS**

Operations requiring more than the machine performance can cause accidents.

Crane operations must always be carried out according to the rated total load chart.

**[8] DON'T WIND WIRE BY FORCE**

Be careful not to hook the wire rope over a tree or steel beam while working.

If it gets stuck, do not force it. Untangle the rope and then wind it.

**[9] DON'T OPERATE DURING TRAVELLING A LOAD**

Operation during travelling a hoisted load may result in the swing of load and tipping over. This is in principle is dangerous. When the operation during travelling a hoisted load is unavoidably, see "OPERATION 3.24 OPERATION DURING TRAVELLING A LOAD " and follow its content and instruction.

**[10] DON'T OPERATE CRANE WORK ON SLOPE**

The crane work on a slope may cause the machine to tip over. This is in principle prohibited.

If work is unavoidably performed on a slope, lay earth (B) on the slope and establish a level, solid foothold to prevent a tipping -over accident before setting the machine.

Be sure to check the level of the machine with the spirit level on the left side of the driver seat.

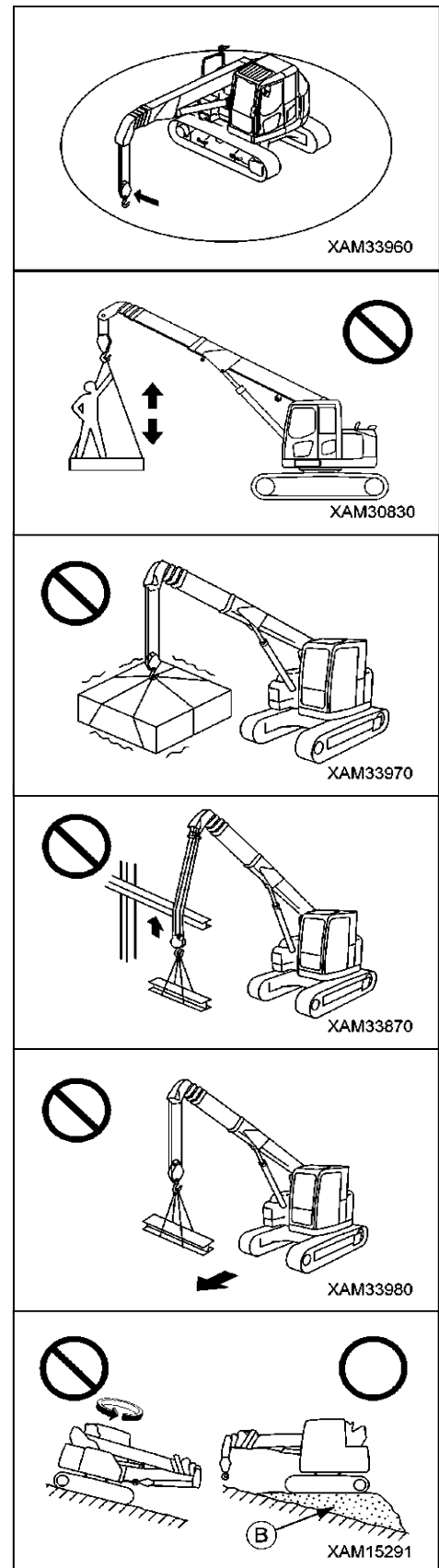



## 3.24 OPERATION DURING TRAVELLING A HOISTED LOAD

### 3.24.1 PRECAUTIONS IN OPERATION DURING TRAVELLING A HOISTED LOAD

#### **⚠ DANGER**

Travel with a lifted load is in principle dangerous because it is very unstable.

If travelling a hoisted load is unavoidably performed, strictly observe the range described in "List of gross rated load for travelling hoist" and travelling hoist posture. "List of gross rated load for travelling hoist" shows values of load the machine can hoist during travelling on the level, solid ground.

Unless these precautions in traveling a hoisted load are observed, serious physical injury may be caused.

#### [1] GROSS RATED LOAD FOR TRAVELLING A HOISTED LOAD AND PRECAUTIONS IN WORKING RANGE

When performing travelling a hoisted load, be sure to observe strictly the gross rated load shown in the table below.

Item	Remarks
Boom length	10.5m (three stage boom) or less
Rated total load	See the list of gross rated load for travelling a hoisted load.

#### [2] PRECAUTIONS IN WORK PLACE

As there is danger of the machine tipping over on the following grounds and places, do not approach them or perform travelling a hoisted load.

Check the condition of the road surface and ground. Arrange a traffic guide for a dangerous place or a place of poor visibility.

- Soft ground such as a slope and marsh, ground with many obstacles, bumpy ground such as a riverbed, ground with difference in level
- Near deep grooves and road shoulder
- In water and shallows, snowy area, frozen road surface

#### [3] PRECAUTIONS IN OPERATION

Never perform the following travelling operation because doing so may cause the machine to tip over.

When operating, be sure to sit on the driver seat and carefully perform the operation during travelling a hoisted load.

- Never perform the crane operation during travelling. Keep the travelling hoist posture.
- Do not raise the load to a high position. Hold it near the ground so that the load does not sway.
- Do not start and stop suddenly, and do not make a sudden direction change. Doing so is dangerous because the load sways.

Be sure to set the travelling speed to "Low speed (1st speed)" to keep the engine speed low and slowly travel.

- Do not travel over an obstacle. The machine is likely to tip over. Be sure to travel on a course clear of obstacles.



### 3.24.2 OPERATION POSTURE DURING TRAVELLING A HOISTED LOAD

#### **⚠ DANGER**

- When having this machine travel with a hoisted load, take the following "Travelling hoist posture".
    - Retract the boom to "10.5m" (three stage boom) or less.
    - Slew the boom to the front center position.
  - Do not perform any operation which changes the above posture during the travelling a hoisted load operation.
- Doing so may cause the machine to tip over, resulting in serious physical injury.**

When having this machine travel with a hoisted load, take the travelling hoist posture shown in the right figure.

1. See "OPERATION 3.19 BOOM TELESCOPING OPERATION" and retract the boom length to "10.5m" (three stage boom) or less.
2. See "OPERATION 3.17 HOISTING AND LOWERING OPERATION " and lower the hoisted load as near to the ground as possible.
3. Press and hold the travelling mode selector switch on the monitor.  
The mode is set to the travelling mode and the travelling mark is displayed on the monitor.

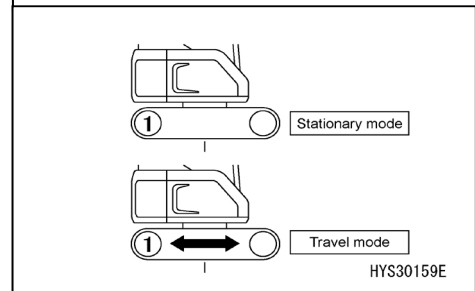
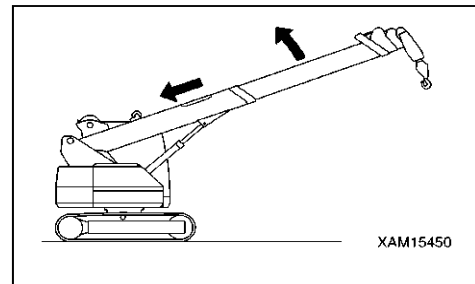

- #### NOTES
- When the boom length is "10.6m" or longer, travel is prohibited and the mode cannot be set to the travel mode. When setting the mode to the traveling mode, set the boom length to "10.5m" (three stage boom) or less.
  - The travelling operation cannot be performed for safety while prohibition of travelling is displayed.
  - When the travelling lever is operated forward or backward, the mode is automatically changed to the travelling mode. However, a priority is given to the setting of the rest/travelling mode selector switch.

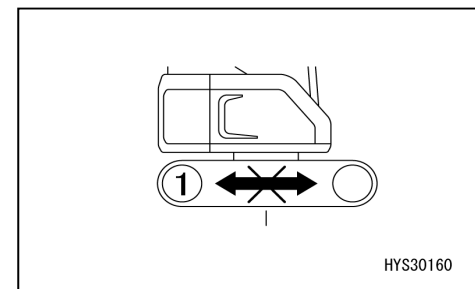

### 3.24.3 OPERATION OF TRAVELLING A HOISTED LOAD WORK

#### **⚠ DANGER**

- When performing travelling hoist work, see "OPERATION 3.24.1 PRECAUTIONS IN OPERATION DURING TRAVELLING A HOISTED LOAD " and try to perform safety work.
- Do not perform any crane operation when travelling with a hoisted load. The machine may overturn.
- When performing travelling hoist work, be sure to sit on the driver seat and carefully perform the travelling a hoisted load operation.
- Check the safety in the vicinity of the machine and honk the horn before starting to move the machine.
- When changing the forward/backward movement of the machine or the direction, check the safety in the vicinity of the machine and honk the horn before making a change.
- Keep the engine speed low during travelling and slowly and carefully travel.  
Keep an extra distance so that the hoisted load or machine does not crash against another machine or structure.

1. When travelling the machine, see "OPERATION 3.8 STARTING (FORWARD AND BACKWARD)/STOPPING THE MACHINE " and "OPERATION 3.9 CHANGING DIRECTION OF THE MACHINE".
2. See "OPERATION 3.17 HOISTING AND LOWERING OPERATION " and "OPERATION 3.18 BOOM DERRICKING OPERATION" and perform the crane operation. At this time, keep the hoisted load height near the ground so that the load does not sway.

#### **NOTES**

When the overload stop function of the moment limiter is activated, see "OPERATIONS 2.4.3 [2] RECOVERY OPERATION FROM AUTOMATIC STOP".

### 3.24.4 CANCEL OPERATION OF TRAVELLING HOIST OPERATION POSTURE

1. See "OPERATION 3.8 STARTING (FORWARD AND BACKWARD)/STOPPING THE MACHINE" and "OPERATION 3.11 MACHINE PARKING "and park the machine.
2. Press and hold the travelling mode selector switch on the monitor.  
The mode is set to the rest mode and the monitor display changes.
3. See "OPERATION 3.7 MACHINE TRAVELLING POSTURE" and put the machine in the "Travelling posture".

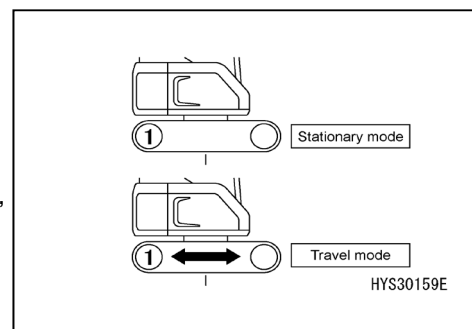



## 4. HANDLING OF WIRE ROPE

### 4.1 CRITERIA FOR WIRE ROPE REPLACEMENT

#### CAUTION

- The criteria for replacing wire ropes is common to all the wire ropes for winching, telescoping the boom, and slinging.
- The diameter of the wire rope is measured at points where the wire repeatedly runs through the sheave. A mean value needs to be determined through 3 way measurement.
- Do not use old wire rope regardless of the frequency of use.
- See "MAINTENANCE 10.3 [1] REPLACEMENT OF WINCH WIRE ROPES" for details.
- Contact us or our sales service agency for replacing/repairing the wire ropes.

#### [1] WIRE ROPE NOMINAL DIMENSION

- Wire rope for winch: IWRC 6 x Fi (29) 0/0  $\phi$ 10 x 115m
- No.5 rope for pulling out boom: IWRC 6 x Fi (29) 0/0  $\phi$ 10
- No.5 rope for pulling in boom: IWRC 6 x Fi (29) 0/0  $\phi$ 8

#### [2] CRITERIA FOR WIRE ROPE REPLACEMENT

A wire rope undergoes wear and tear over time.

Prompt replacement is required if any of the following appears in the wire rope.

1. With respect to the total number of elemental wires in the outermost strand (excluding filler wires), when the number of broken wires is equal to or greater than the following ratio.
  - (1) 10% or more of a single twist of rope. Nevertheless, when breakage occurs in a single strand only, the ratio should be 5% or more.
  - (2) 20% or more of 5 twists of rope.
2. A rope of which reduction in diameter due to abrasion exceeds 7% of nominal diameter of the nominal diameter.

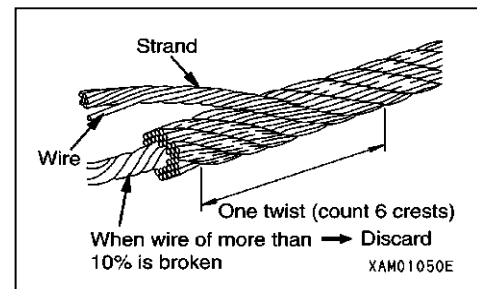

<b>NOTES</b>
Replace the 10mm diameter wire rope when it is reduced to 9.4 mm.

3. When either of the following is observed due to corrosion:
  - (1) Pitching occurred on the wire surface, that has turned pockmarked.
  - (2) Wires that have lost tension due to internal corrosion.

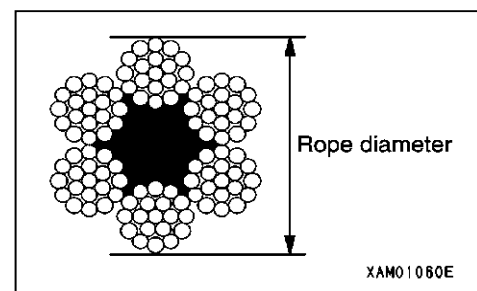



4. As a result of form collapsing, the following are observed:
- (1) A strand that is kinked.
  - (2) When the width of an undulation exceeds  $\frac{4}{3}d$  within a section that is 25 times of nominal diameter  $d$ .
  - (3) When a wire rope is flattened by local crushing and the minimum diameter is  $\frac{2}{3}$  of the maximum diameter or less
  - (4) A rope of which core wires or rope core is exposed.
  - (5) A rope extremely bent
  - (6) A rope appearing like a cage
  - (7) A strand that has been intruded.
  - (8) One or more strand is loosened.
  - (9) Wires that are noticeably sticking out.
5. An end socket that is found faulty.

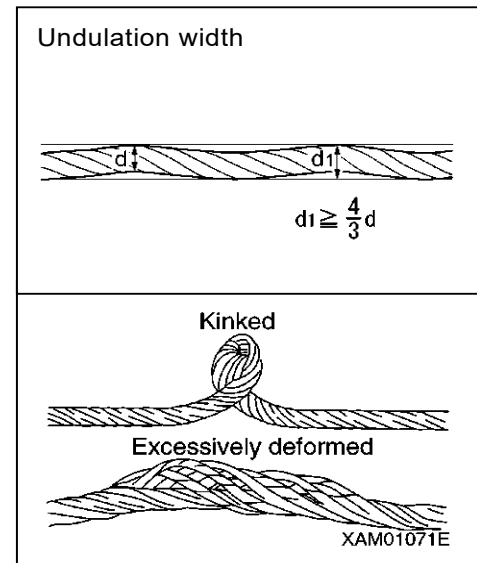

## 4.2 WINCH WIRE ROPE REEVING SYSTEM AND GROSS RATED LOAD

Use a wire rope so that the load per wire rope is "1500 kg" or more.

The table below shows the type of a hook block, number of falls of a wire rope and the maximum gross rated load at that time.

Hook type	Hook used for both 2 falls and 4 falls	Hook used for both 2 falls and 4 falls	Hook exclusive for single fall
Number of falls	4 fall	2 fall	Single fall
Reeving system	<p>XAM32110</p>	<p>XAM32130</p>	<p>XAM32140</p>
Maximum gross rated load	6000 kg	3000 kg	1500 kg
Mass of hook	90 kg	90 kg	20 kg



### 4.3 MEASURE TO TAKE WHEN WINCH WIRE ROPE IS TWISTED

#### ⚠ WARNING

Always put on thick leather work gloves when handling the wire rope.

#### CAUTION

Rewind the wire rope from time to time so that the hook block side and the winch drum side are opposite to each other.

Doing so lengthens the wire rope life.

When the wire rope is twisted, correct the twist in the following steps.

1. Check the twisting direction from the normal state of the hook and the number of times of twist.
2. Operate the left work equipment operation lever to the "Retract" side (pull toward you) to retract the boom fully.
3. Operate the right work equipment operation lever to the "Lower" side (push outside) to lower the boom angle to approximately 20 degrees.
4. Operate the right work equipment operation lever to the "Lower" (push forward) side and lower the hook block to the verge of touching the ground. Then, operate the right work equipment operation lever to the "Lower" (push outside) side and lower the hook block to the ground and lower the boom to the maximum.
5. Operate the starter switch to the "OFF" position to stop the engine. After that, place the lock lever at the lock position.
6. Remove the fixing bolt (1) to pull out the wedge socket pin (2) and remove the wedge socket pin (3).
7. Install the wire rope end by forcibly twisting "n" (number of falls of wire rope) times the number of twisting of the hook block in the opposite direction (the opposite direction to which the wedge socket tries to return naturally when you release your hand from it) to the hook block twisting checked in Section 1.
8. Start the engine and operate the boom derricking lever to "Raise" side (pull inside) to set the boom derricking angle to the maximum.
9. Operate the left work equipment operation lever to the "Extend" position (push forward) to set the boom length to the longest.
10. Operate the right work equipment operation lever to the "Raise" or "Lower" side and repeat the raising and lowering of the hook block several times.
11. Roll in the winch drum in good order with tension applied to the wire rope.

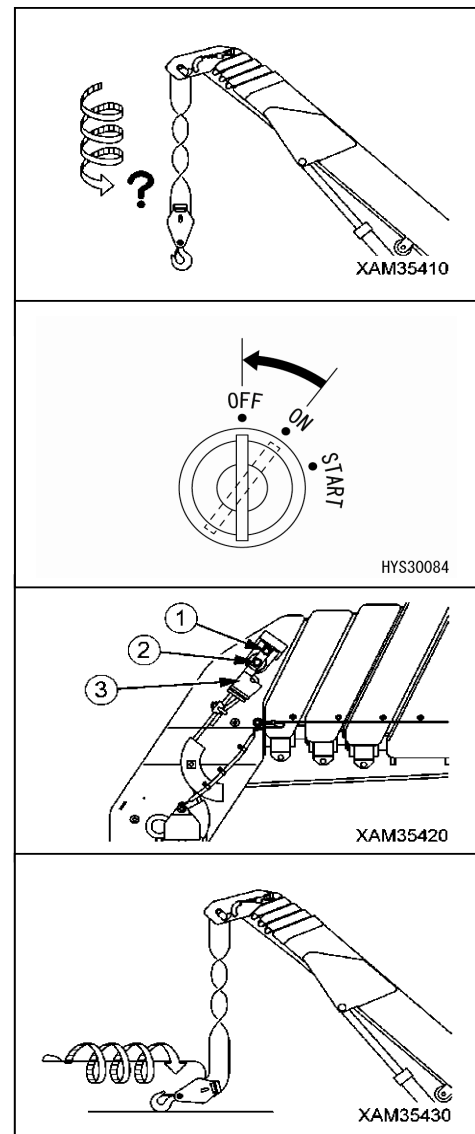



12. Repeat the above steps until the twist of the hook is eliminated.

Replace the wire rope with a new one if the twist is not corrected by the above steps.

## 5. TRANSPORTATION

Observe the related regulations and exercise safety during transport.

### 5.1 LOADING/UNLOADING

#### **⚠ WARNING**

- See "SPECIFICATION 1. MAIN SPECIFICATION TABLE" for the dimensions and mass of this machine.
- Select ramp boards to be used which satisfies the following conditions.
  - Length must be such that the setting angle onto a trailer is 15 degrees or less.
  - The width must be such that the crawler does not protrude from the ramp boards.
  - The thickness and strength must be such that can fully stand the mass of this machine.
- Set the ramp boards at right angles to the trailer bed.  
Align the center of the right and left crawlers with the center of the respective ramp boards. If the ramp boards are bent or the center of the crawler is off, the machine may fall from the ramp boards, causing serious physical injury.
- Always put the machine in the "travelling posture" when loading/unloading the machine. See "OPERATION 3.7 TRAVELLING POSTURE OF MACHINE" for details.
- Be sure to turn the auto deceleration switch to "OFF" (Cancel). If the machine is operated with the auto deceleration switch turn "ON" (Operation), the machine may make a sudden start.
- Be sure to set the travelling speed to the low speed range (LO) and load and unload the machine with engine speed set to low speed.
- Always move backward when loading the Machine. Moving forward may cause the machine to fall.
- Always move forward when unloading the Machine. Moving backward may cause the machine to fall.
- Be especially careful when loading or unloading the Machine because the risks intervene.
- Select a location that is level and has firm road surface when loading or unloading the Machine.  
In addition, keep enough distance from the roadside.
- Remove the mud and other substances from the footing to prevent the Machine from skidding over the ramps.
- Remove the substances stuck on the ramp boards such as grease, oil, snow or ice, and keep clean.
- Never change direction over the ramp boards. Temporarily leave the ramp boards before correcting the direction.
- As the center of gravity position of the machine suddenly shifts at a boundary between the ramp and trailer, balance is lost, causing danger. Pass the ramp slowly.
- Check that the cab slide door is securely locked when it is closed and opened. Avoid opening/closing the door on the ramp boards or forwarding blocks because the operating force may change suddenly.

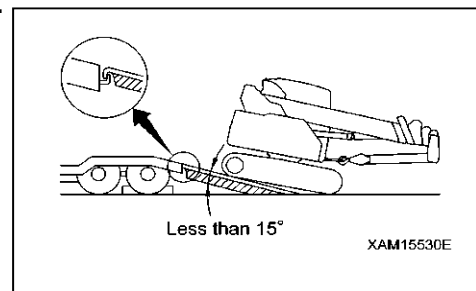



Put the machine in the “travelling posture” and always use ramp boards or forwarding blocks when loading/unloading the machine. Follow the procedure below.

### 5.1.1 LOADING

1. Select a level and firm road surface for loading the machine.  
In addition, keep enough distance from the roadside.
2. Brake the trailer securely. Place wheel blocks next to the wheels of the trailer to secure the trailer.
3. Ramp boards must be suitably aligned so that the machine rests in the centre of the trailer.

<b>NOTES</b>
<ul style="list-style-type: none"> <li>• Set the right and left ramp boards in paralell at the same distance for the right and left with respect to the center of the trailer.</li> <li>• The installation angle of the ramp boards must be 15 degrees or less.</li> <li>• Securely hang the hooks of the ramp boards on the hooks of the trailer.</li> <li>• If the ramp boards are bent by the machine weight, place a block such as lumber under the ramp boards to prevent bending.</li> </ul>

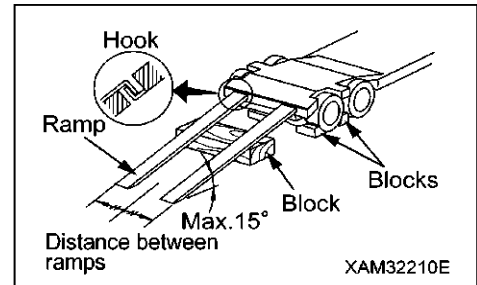

4. Start the engine.  
Warm up the engine enough in cold climate.
5. Place the lock lever at the free position (F).

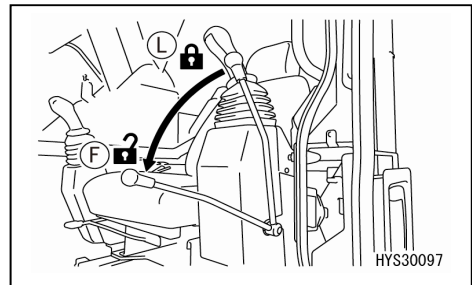

6. Turn the travelling speed range to low speed travelling (1st speed).  
To change the travelling speed range, press the travelling 1st speed/2nd speed selector switch.
7. Set the engine speed to low speed with the fuel adjustment dial.

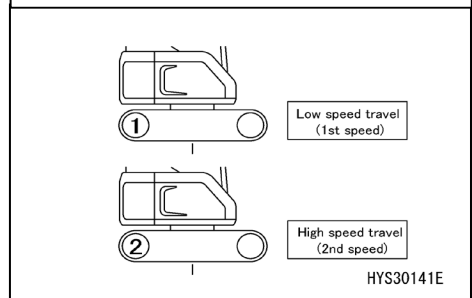



8. Before getting on the ramp boards, check that the machine is positioned in a straight line to the ramp boards and that the center of the machine is aligned with the center of the trailer.
9. Fix the direction toward the ramp boards and slowly travel for loading. At this time, do not operate any other lever than travelling levers on the ramp boards.
10. The machine becomes unstable when it gets over rear wheels of the trailer. Therefore, travel slowly and carefully. The direction change is strictly prohibited.
11. The machine inclines backward when it has got over the rear wheels. Move backward to the specified position with care and stop.

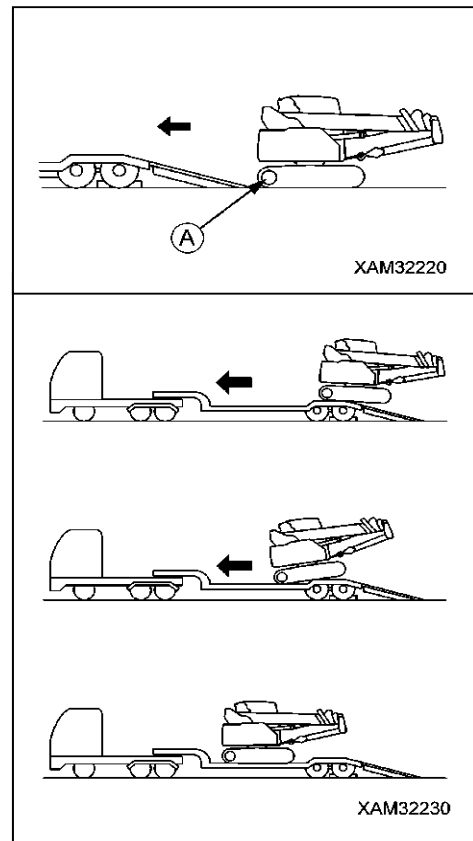

### 5.1.2 FIXING THE MACHINE

#### CAUTION

Store the radio antenna. Re-assemble mirrors so that they are within the machine body width.

After loading the machine to the specified position of the trailer, fix the machine in the following steps.

1. Place the lock lever (1) securely in the lock position (L).

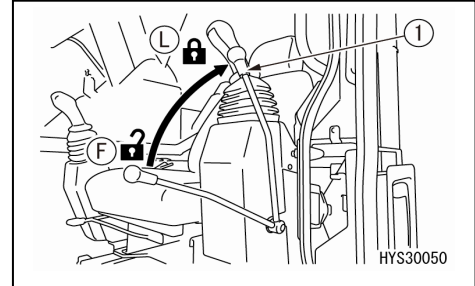

2. Stop the engine and remove the starter switch key.

3. Close all the doors, windows and covers.

Lock the door, covers and caps with lock.

4. Put blocks of wood in front and back of the crawler to prevent the machine from moving during transportation and use chains or wire ropes of appropriate strength for secure fixing.

Especially, at this time, properly fix it so it will not move from side to side.

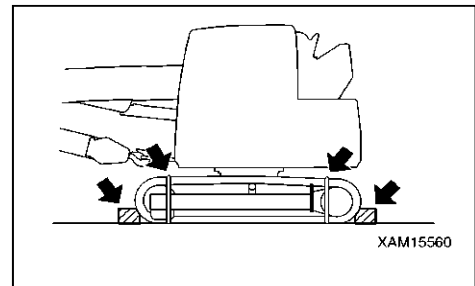

#### NOTES

At this time, put nailing strips between the wire rope and machine so that the wire rope and machine are not damaged.

### 5.1.3 UNLOADING

1. Select a level and firm road surface for unloading the machine. In addition, keep enough distance from the roadside.
2. Brake the trailer securely. Place wheel blocks next to the wheels of the trailer to secure the trailer.
3. Ramp boards must be suitably aligned so that the machine rests in the centre of the trailer.

#### NOTES

- Set the right and left ramp boards in parallel at the same distance for the right and left with respect to the center of the trailer.
- The installation angle of the ramp boards must be 15 degrees or less.
- Securely hang the hooks of the ramp boards on the hooks of the trailer.
- If the ramp boards are bent by the machine weight, place a block such as lumber under the ramp boards to prevent bending.

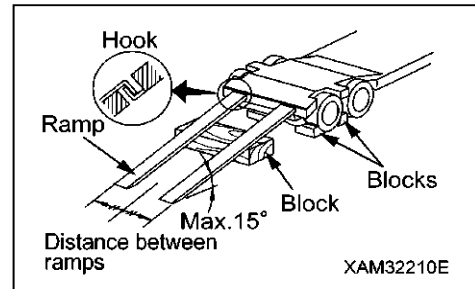

4. Remove the chain or wire rope which fixes the machine.
5. Start the engine.  
Warm up the engine enough in cold climate.
6. Place the lock lever at the free position (F).

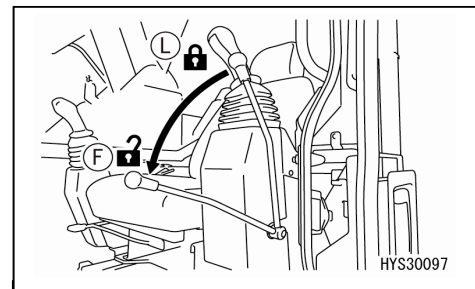

7. Turn the travelling speed range to low speed travelling (1st speed).

To change the travelling speed range, press the travelling speed 1st speed/2nd speed selector switch.

8. Set the engine speed to low speed with the fuel adjustment dial.

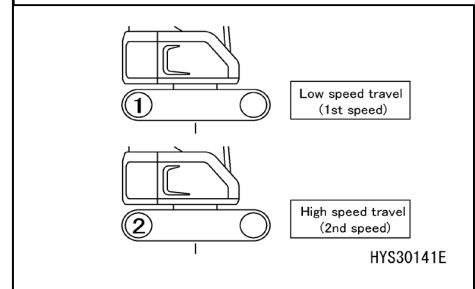

9. Fix the direction toward the ramp boards and slowly travel for unloading. At this time, do not operate any other lever than travelling levers on the ramp boards.

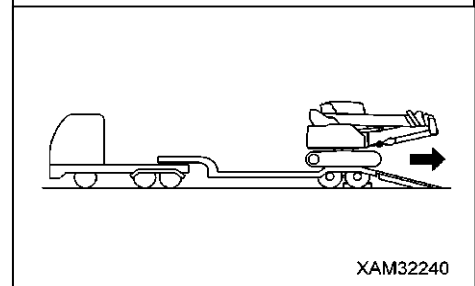

## 5.2 HOISTING MACHINE

### 5.2.1 HOISTING MACHINE WITH BOOM LOWERED

#### **⚠ DANGER**

- See "SPECIFICATION 1. MAIN SPECIFICATION TABLE" for the dimensions and mass of this machine.
- A person who uses the crane to perform hoisting operation must have the crane operation qualifications.
- Do not perform hoisting operation with a worker placed on the machine.
- Only use a sling (e.g. wire rope and shackles) which is approved and capable of lifting the mass of the machine.
- Put the machine into a level state when lifting.
- When performing lifting work, place the lock lever at the lock position to prevent the machine from moving unexpectedly.
- Never get under or around the lifted machine.
- Be sure to lift the machine only in the following procedure and at the sling installation position (pass the wire rope for slinging through between the 1st and 2nd of the track crawler from the front of the machine and between the 1st and 2nd from the rear). If the machine necessarily needs to be lifted in other manner, consult us or our sales service agency.

#### **CAUTION**

- When lifting the machine, use the exclusive sling and two wire ropes of the same standard. When lifting the machine, be careful not to allow the wire ropes for slinging to contact the main body of the machine.
  - Wire rope: Breaking load 24.5 tons
  - Shackle: Working load 14.0 tons
- When lifting the machine with the boom lowered, be sure to store the hook block in the simple stowage position (boom tip). See "OPERATION 3.7 MACHINE TRAVELLING POSTURE" for details.

When lifting the machine, perform the following on a firm, level ground.

1. Set the Machine to the "Travelling posture" in the right figure.

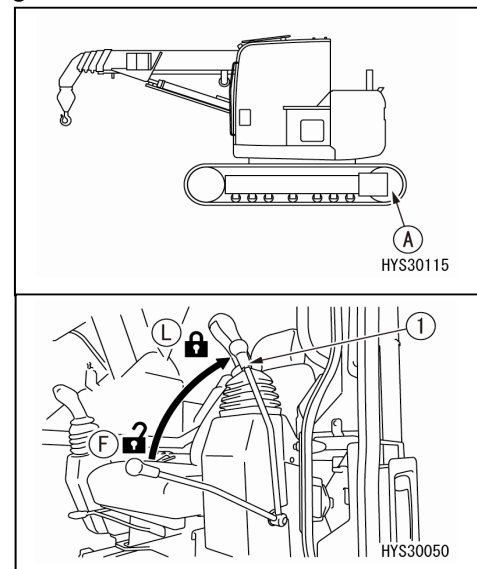

2. Place the lock lever (1) securely in the lock position (L).

3. Stop the engine and remove the starter switch key. Check that there is nothing around the driver seat and get off the machine.

4. Close all the doors, windows and covers.  
Lock the door, covers and caps with lock.





5. Pass the wire rope for slinging through between the 1st and 2nd of the track crawler from the front of the machine and between the 1st and 2nd from the rear.
6. Put nailing strips between the wire rope and machine so that the wire rope and machine are not damaged.
7. Set the slinging angle of the wire rope for slinging to 20 - 30 degrees and slowly lift the machine.

**NOTES**

Immediately after lifting (dynamic lift off), stop once to check the sling state and sling posture.

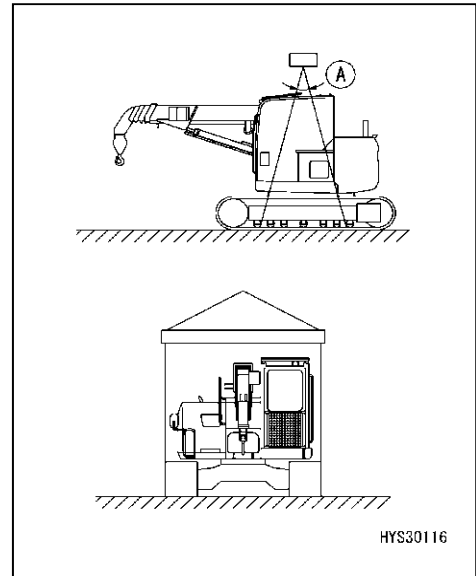

HYS30116

### 5.2.2 HOISTING MACHINE WITH BOOM

#### **⚠ DANGER**

- See "SPECIFICATION 1. MAIN SPECIFICATION TABLE" for the dimensions and mass of this machine.
- A person who uses the crane to perform hoisting operation must have the crane operation qualifications.
- Do not perform hoisting operation with a worker placed on the machine.
- Only use a sling (e.g. wire rope and shackles) which is approved and capable of lifting the mass of the machine.
- Put the machine into a level state when lifting.
- When performing lifting work, place the lock lever at the lock position to prevent the machine from moving unexpectedly.
- Never get under or around the lifted machine.
- Be sure to lift the machine only in the following procedure and at the sling installation position (right and left bracket hole position of the boom at two locations). If the machine necessarily needs to be lifted in other manner, consult us or our sales service agency.

#### **CAUTION**

- When lifting the machine, use two wire ropes for slinging of the same standard and two shackles.
  - Wire rope: Breaking load 78.9 tons
  - Shackle: Working load 14.0 tons
- When lifting the machine with the boom raised, be sure to hang the hook block on the rope for stowage. Be careful not to overtighten the rope.

When lifting the machine, perform the following on a firm, level ground.

1. Retract the boom fully, raise it to 65 - 70 degrees and hand the hook block on the rope for stowage for simple stowage.
2. Slew the revolving super structure so that the sprocket (A) is in the front of the machine.

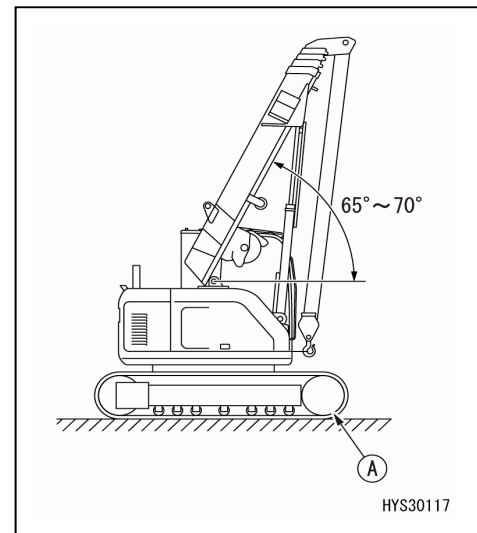

3. Place the lock lever (1) securely in the lock position (L).
4. Stop the engine and remove the starter switch key. Check that there is nothing around the driver seat and get off the machine.
5. Close all the doors, windows and covers.  
Lock the door, covers and caps with lock.
6. Attach a shackle to two locations of the right and left of the boom, then attach the slinging wire ropes.
7. Lift the machine slowly.

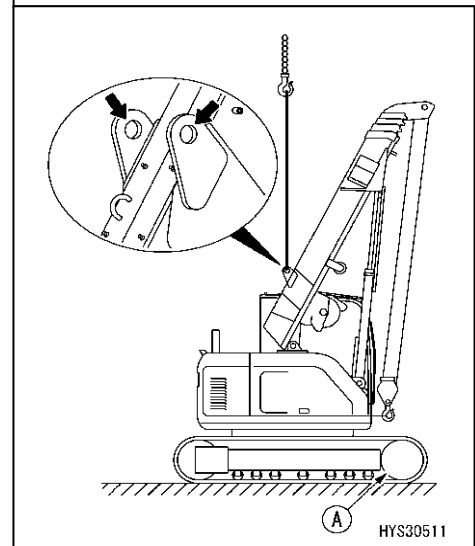
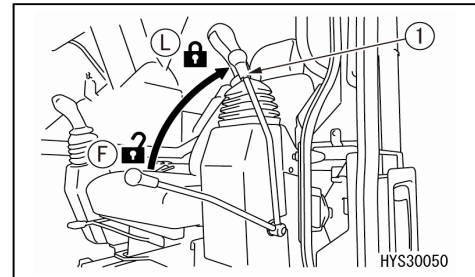

### NOTES

- Immediately after lifting (dynamic lift off), stop once to check the sling state and sling posture.
- Check if the posture changes due to leaks of the hydraulic circuit on the derricking cylinder head side.
- When the machine body is lifted, it inclines backward by approximately 2 degrees and toward the driver seat by approximately 3 degrees. The inclination angle changes slightly depending on the boom angle and remaining quantity of fuel.

## 5.3 CAUTIONS DURING TRANSPORTATION

### **⚠ WARNING**

**Take road width, height, and weight into consideration in determining the transportation route.**

- If there are any applicable local laws or regulations, observe them for safe transportation.
  - Road Traffic Law, Road Law (Vehicle Restriction Ordinance), Road Transport Vehicle Act (Safety Standard), Municipal Bylaws
- Investigate the road width, bridge girders, and height of aerial lines, weight limitations and traffic regulations in advance. Thoroughly study if there is any problem when the machine is transported by a trailer.
- In some cases, it is necessary to obtain an approval from the authorities concerned or take measures of disassembling the machine for transportation.  
Transport the machine upon consulting the carrier.
- Contact us or our sales service agency for disassembly and transportation.



## 6. HANDLING WHEN COLD

### 6.1 PREPARING FOR LOW TEMPERATURE

In cold conditions, the machine starts to have some difficulty in starting. Take the following actions.

#### [1] LUBRICATION

Change the lubricating oil to one with a lower viscosity.

See "MAINTENANCE 7.1 USE OF FUEL AND LUBRICATING OIL ACCORDING TO TEMPERATURE" for the specified viscosity.

#### [2] COOLANT

##### **⚠ WARNING**

- **Keep antifreeze away from flames. Antifreeze is a flammable solution. Do not smoke when handling antifreeze.**
- **Antifreeze is toxic. Keep it away from your eyes and skin. Should it come into contact with eyes or skin, wash the affected area with plenty of water and consult a physician immediately.**
- **Instruct a vendor to treat the antifreeze added coolant discharged at the time of coolant replacement and repair, or contact us or our sales service agency. As antifreeze is toxic, do not drain it into a ditch or spray it on the ground.**

##### **CAUTION**

Never use antifreezing fluid with methanol, ethanol, and propanol.

See "Maintenance 10.3 Irregular Maintenance [4] Cleaning Engine Cooling System" for the coolant replacement period and mixing rate of antifreezing fluid.

#### [3] BATTERY

##### **⚠ WARNING**

- **The battery produces combustible gas and can be explosive. Do not put fire close to the battery.**
- **The battery fluid is a hazardous substance. Keep it away from your eyes and skin. Should it come into the contact with eyes or skin, wash the affected area with plenty of water and consult a physician immediately.**
- **If the battery fluid is frozen, do not charge battery or start the engine using other power source. Doing so may cause explosion.**
- **As battery fluid is toxic, do not drain it into a ditch or spray it on the ground.**

The battery capacity drops when the temperature decreases.

In this condition, the battery fluid can freeze with low battery charging rate. Keep the charging rate as close to as 100 %. Keep the battery warm in order to start the engine next morning.



**NOTES**

Measure the specific gravity of the battery fluid and convert it into the charging rate using the chart below.

		Fluid Temperature (°C)			
		20	0	-10	-20
Charging Rate (%)	100	1.28	1.29	1.30	1.31
	90	1.26	1.27	1.28	1.29
	80	1.24	1.25	1.26	1.27
	75	1.23	1.24	1.25	1.26

**[4] CAUTIONS AFTER COMPLETING THE OPERATION**

Observe the following to prevent the machine from not being able to function the next morning because of deposits such as dirt and water and materials around the frozen tracks.

- Remove dirt and water on the machine.  
Keep the hydraulic cylinder rod surfaces especially clean to prevent seals from being damaged with dirt entering into the seals together with the water drops.
- Park the machine on solid and dry ground.  
If there is no such location to park, place a board on the ground to park the machine on. This prevents the ground and around the tracks of the machine from freezing and allows the machine to start moving quickly next morning.
- Open the drain valve of the fuel tank to drain the water in the fuel system to prevent the water from freezing.
- Fill up the fuel tank to full. Doing so prevents waterdrops from being formed inside the tank due to a change in temperature.
- The battery ability noticeably drops at low temperature.  
Cover the battery or remove the battery from the machine and keep it in a warm place to be installed next morning.
- If the electrolyte level is low, refill with distilled water next morning before starting the operation.  
Do not refill after the operation in order to prevent the water from freezing during the night.

**[5] AFTER COLD WEATHER HAS PASSED**

When the season changes and starts to get warm, take the following action.

- See "MAINTENANCE 7.1 USE OF FUEL AND LUBRICATING OIL ACCORDING TO TEMPERATURE" to change the oil in the system to the one with specified viscosity.

## 7. LONG-TERM STORAGE

### 7.1 BEFORE STORING MACHINE

#### CAUTION

Keep the machine in the "Travelling posture" shown in the figure on the right during long-term storage to protect the cylinder rod. See "Operation 3.7 Travelling Posture of Machine" for details. (To prevent rust on the cylinder rod)

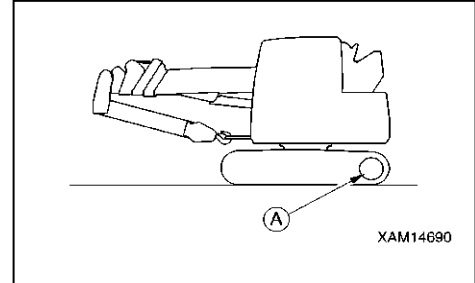

Store the machine as described below when storing it for one month or longer:

- Wash and clean each section of the machine and store indoor.  
If you have to leave it outdoors, select a flat location where the machine is not likely to be exposed to flood or other disasters and cover the machine.
- Fill up the fuel tank to full. Doing so prevent the accumulation of water.
- Refuel, grease, and change the oil without fail.
- Apply grease to the exposed section of the piston rod of the hydraulic cylinder.
- Disconnect the negative terminal of the battery and put on a cover, or dismount the battery from the machine for storage.
- If the temperature drops to 0 °C or below, add antifreezing solution. Contact us or our sales service agency for the mixing amount of antifreeze solution.

### 7.2 DURING STORAGE

#### WARNING

If you have to perform antirust operation indoors, open the window and entrance for better ventilation to prevent gas poisoning.

- Be sure to operate the machine once a month during the storage to maintain the oil film at lubricating section. Charge the battery at the same time.
- Before operating the crane, wipe off grease applied to the exposed section of the piston rod of the hydraulic cylinder.
- Operate the cooler at low idle for 3 - 5 minutes once a month to keep the oil in all parts of the A/C compressor. In addition, inspect the amount of refrigerant gas twice a year.



## 7.3 AFTER STORAGE

### CAUTION

If you did not perform antirust operation monthly during the long-term storage, contact us or our sales service agency before using the machine.

Perform the following before using the machine after the long-term storage.

- Remove the drain plug of the fuel tank, hydraulic oil tank, and engine oil pan to drain the water mixed in.
- Refuel, grease, and change the oil without fail.
- Wipe off grease applied to the exposed section of the piston rod of the hydraulic cylinder.
- Remove the cover over the battery (install the battery to the machine if dismantled for storage). Check the electrolyte level and specific gravity, and then connect the negative side of the battery cable.
- Carefully perform the check before starting operation and perform warm-up operation. Carefully check the various parts of the machine.

## 8. TROUBLESHOOTING

### 8.1 WHEN FUEL RUNS OUT

When starting the engine after fuel runs out, refill fuel and bleed air from the fuel system before starting the engine.

#### [PROCEDURE FOR AIR BLEEDING]

#### **WARNING**

**Start the engine and check if the fuel system leaks. A fuel leak causes a fire.**

- The entry of air into the fuel system causes engine starting difficulty and engine malfunction. Be sure to bleed air when the fuel tank is emptied, water is drained from the fuel and a filter element is replaced.
- Bleed air in the main filter (1).

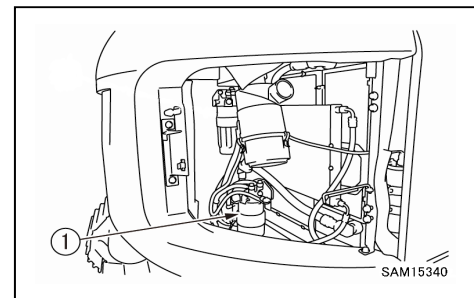

1. Place the starter switch at the "START" position and put the electromagnetic pump into an operating state.

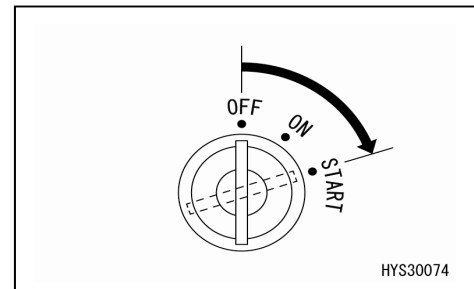

2. Sufficiently loosen the air vent plug (2) of the fuel filter and push the priming pump (4) with your hand to operate until the fuel comes out.
3. Loosen the air vent plug (2) and operate the priming pump (4) at least 10 times until the fuel filter is filled with fuel.
4. Wait for about 1 minute and loosen the air vent plug (2) to bleed air in the fuel filter.
5. Repeat the procedure from 2 to 4 at least 3 times until no air comes out from the air vent plug (2).
6. Firmly tighten the air vent plug (2) and wipe off the fuel in the surroundings.
7. Start the engine without operating the engine speed on the machine side. If the engine does not start at this time, perform the operation from the procedure 3 again.
8. Keep the engine at idle for 5 seconds after engine start.
9. Slowly increase the engine speed and hold that state for 3 minutes.
10. Increase the engine speed to the max. revolution and then return it to idling speed again.

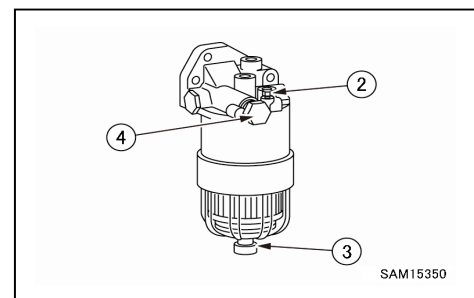





11. Repeat the operation of the procedure 8 to 10 several times.

## 8.2 PHENOMENONS THAT ARE NOT A FAULT

The following phenomena are not a fault.

- A sound is generated from around the valve when the boom is retracted to the end and the telescopic cylinder is relieved on the retraction side.
- A sound is generated from the brake valve at the beginning and end of slewing.
- A sound is generated from the travelling brake valve when the machine travels on a steep downhill at low speed.

## 8.3 WHEN BATTERY HAS DISCHARGED

### 8.3.1 BATTERY HANDLING PRECAUTIONS

#### **⚠ WARNING**

- It is dangerous to charge the battery in an installed condition. Be sure to remove it from the machine and charge it separately.
- Stop the engine and turn the starter switch to the “OFF” position when checking/handling the battery.
- Wipe off the dust accumulated on the top of the battery with a moistened cloth.
- The battery produces hydrogen gas, which may cause an explosion hazard. Do not put fire such as cigarettes close to the battery or take any actions that can cause sparks.
- The battery fluid is diluted sulfuric acid, which corrodes clothes and skin.  
Should the battery fluid come into contact with your clothes or skin, wash the affected area immediately with plenty of fresh water.  
Should it go into your eye, wash your eye immediately with clean water and consult a physician.
- Wear goggles and rubber gloves when handling the battery.
- Disconnect the ground side (normally (-) terminal) first to remove the battery cable, and conversely, connect the (+) terminal first to install the battery cable.  
Objects such as tools coming between (+) terminal and the machine body will cause sparks, which is dangerous.
- Slackened battery terminals can cause sparks with poor contact, causing an explosion hazard. Tighten securely when installing the terminals.
- Secure the battery when changing it to prevent it from being displaced. If it is not secured, the terminals will slacken, causing sparks.
- Verify the (+) terminal and (-) terminal when removing and installing the battery cable.

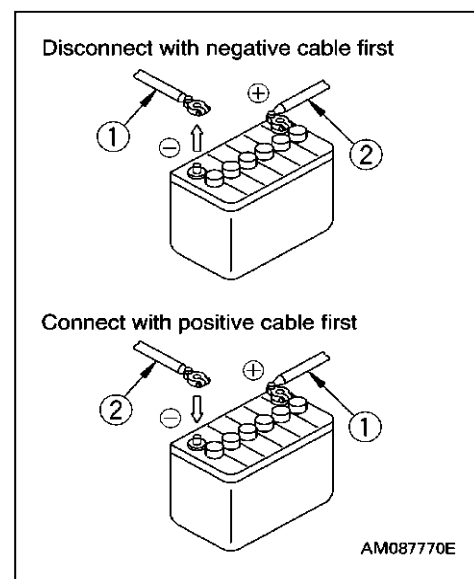

Observe the following when handling the battery.

- Always try to keep the battery charged.  
The battery should not be charged in a rush after being discharged. Measure the specific gravity of the battery fluid in advance and charge the battery as needed.  
Keeping the battery in the best condition lengthens the life of the battery.
- Check the electrolyte level earlier than regular check and maintenance schedule during the hot season.
- The battery ability drops significantly during the cold season. Keep the charging rate as close to as 100 % and try to keep it warm for starting the operation next morning.  
Distilled water should be refilled before starting the work next morning to avoid freezing.

### 8.3.2 REMOVING/INSTALLING BATTERY

#### CAUTION

Verify that the battery does not move after securing the battery. If it moves, secure it again.

#### [1] REMOVAL

1. Open the battery room door and turn up the vinyl cover installed on the battery.

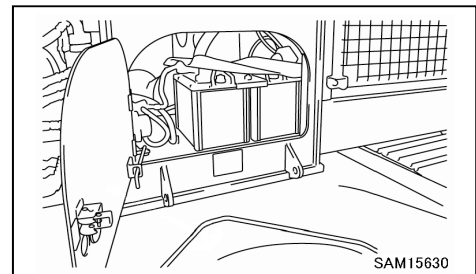

2. First, remove the cable (2) on the (-) terminal side (ground side) of the right-hand battery.

3. Remove the cable (3) on the (+) terminal side of the left-hand battery.

4. Remove the connection cable (4).

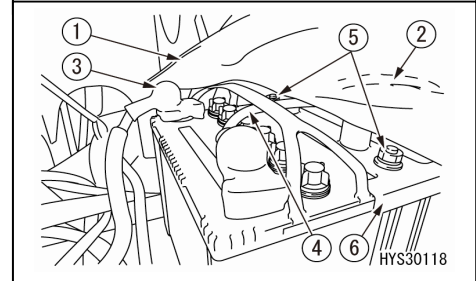

5. Remove the mounting bolt (5) at two locations and remove the mounting bracket (6) and vinyl cover (1).

6. Take the battery outside of the machine body.

#### [2] INSTALLATION

1. Set the battery in place.

2. Set the mounting bracket (6) and vinyl cover (1) on the battery and securely tighten the mounting bolt (5).

★Tightening torque of bolt (5): 9.8 - 19.6 N·m (1 - 2 kgf·m)

3. Install the cable (3) on the (+) terminal side of the left-hand battery.

4. Connect the connection cable (4) from the (+) terminal side.

5. Install the cable (2) on the (-) terminal side (ground side) of the right-hand battery.

### 8.3.3 CAUTIONS IN CHARGING BATTERY

If you make a handling mistake during battery charging, the battery may explode.

Strictly observe the following according to "Operation 8.3.1 Precautions in Handling Battery" and the instruction manual attached to the charger.

- Adjust the charger voltage to suit the voltage of the battery to charge. Mistake in setting the voltage may cause explosions due to overheat and ignition of the charger.
- Securely fix the (+) charge clip of the charger to the (+) terminal of the battery, then securely fix the (-) charge clip of the charger to the (-) terminal of the battery.
- Set the charge current to "1/10" or less of the battery rated capacity.

In the case of boost charge, set the charge current to the value of rated capacity or less. Excessive charge current may cause fire and explosions due to fluid leaks or fluid deficiency.

- If the battery fluid is frozen, do not charge the battery or start the engine using other power source. The battery fluid may catch fire, causing explosion.
- Do not use or charge the battery when the electrolyte level is at or below (LOW LEVEL). Doing so may cause an explosion.

Be sure to conduct regular inspection of the battery electrolyte level and refill purified water (example: commercial battery replenisher) to the maximum electrolyte level (UPPER LEVEL).

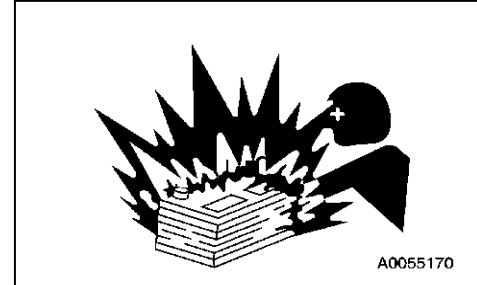

### 8.3.4 STARTING ENGINE WITH BOOSTER CABLE

Start the engine with booster cable as described below.

#### [1] CAUTIONS IN CONNECTING/DISCONNECTING BOOSTER CABLE

##### **⚠ WARNING**

- Never let the (+) terminal come into contact with the (-) terminal when connecting the cable.
- Wear goggles and rubber gloves when starting the engine with the booster cable.
- Do not let the donor machine and machine in failure come into contact with each other.  
Because the battery produces hydrogen gas, sparks around the battery can cause an explosion.
- Do not make mistakes in connecting the booster cable. Note that there will be some sparks when making the last connection. Make this connection at the location as far as possible from the battery.
- Do not let the booster cable clips contact each other or the machine when disconnecting the booster cable.

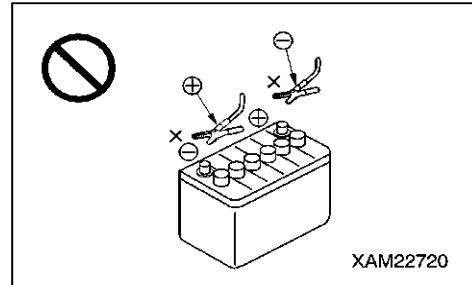

XAM22720

##### **CAUTION**

- Use booster cable and clips of appropriate size for the battery size.
- The battery in the donor machine and machine in failure should be of the same capacity.  
The starting system of this machine is 24V.
- Check that the cable and clips have no breakage or corrosion.
- Connect the clips securely.
- Verify that each operation lever is at the neutral position.

#### [2] CONNECTING BOOSTER CABLE

Set the starter switch of both the normal machine and the failed machine to the "OFF" position.

Connect the booster cables in the numerical order shown in the figure on the right.

1. Connect a clip of the booster cable (A) to the (+) terminal of the failed machine.
2. Connect the other clip of the booster cable (A) to the (+) terminal of the battery of the normal machine.
3. Connect a clip of the booster cable (B) to the (-) terminal of the battery of the normal machine.
4. Connect the other clip of the booster cable (B) to the revolving super structure frame of the failed machine.

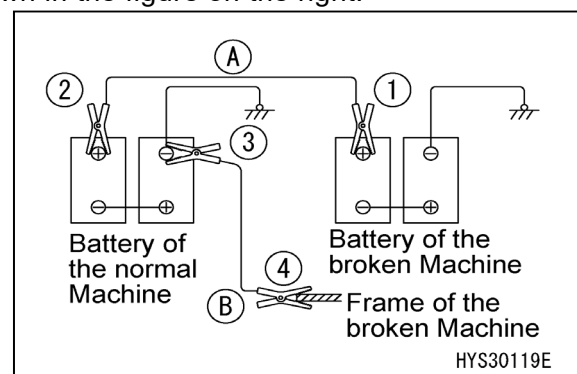

HYS30119E

### [3] STARTING ENGINE

#### ⚠ CAUTION

Verify that the lock lever of both the normal machine and failed machine is at the lock position. In addition, verify that each operation lever is at the neutral position.

1. Verify that the clips are securely connected to the battery terminals.
  2. Start the engine of the donor machine and increase the engine speed to full speed (highest speed).
  3. Set the starter switch of the failed machine to the "START" position and start the engine.
- If the engine does not start, wait for more than 2 minutes before next attempting to start.

#### NOTES

See "Operation 3.3 Starting Engine" for how to start the engine.

### [4] DISCONNECTING BOOSTER CABLE

When the engine has started, disconnect the booster cable in the reverse order of connecting the booster cable.

1. Disconnect the clip of the booster cable (B) connected to the revolving super structure frame of the failed machine.
2. Disconnect the clip of the booster cable (B) to the (-) terminal of the battery of the donor machine.
3. Disconnect the clip of the booster cable (A) connected to the (+) terminal of the battery of the donor machine.
4. Disconnect the clip of the booster cable (A) connected to the (+) terminal of the battery of the failed machine.

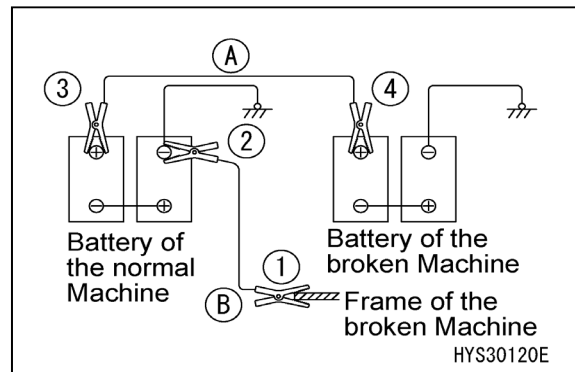



## 8.4 WHEN SUCH A PHENOMENON OCCURS

### 8.4.1 ELECTRICAL COMPONENTS

- Make sure that you contact us or our sales service agency for the actions marked with ★ in the table.
- Ask us or our sales service agency for repair if you suspect any other abnormalities or cause than those given below.

Abnormal Phenomenon	Major cause(s)	Remedy
Dark light even at highest engine speed	• Defective wiring, deterioration of battery	★Check and repair loosened terminals and open circuits, replace battery.
Light blinks during engine operation	• Looseness of fan belt	★Replace fan belt, check tension.
Battery charge monitor remains illuminated even after the engine starts	• Defective alternator • Defective wiring	★Replacement ★Inspection and repair
Abnormal noise from alternator	• Defective alternator	★Replacement
Starter not rotating even after the starter switch is turned	• Defective wiring • Defective starter • Insufficient battery charge	★Inspection and repair ★Replacement • Charge the battery
Starter pinion going out and in repeatedly (struggling)	• Insufficient battery charge • Defective safety relay	• Charge the battery ★Replacement
Starter motor turning slow	• Insufficient battery charge • Defective starter	• Charge the battery ★Replacement
Starter disengaged before the engine starts	• Defective wiring, defective ring gear and pinion • Insufficient battery charge	★Inspection and repair • Charge the battery
Engine does not start even after the starter key is turned	• Defective power circuit of engine controller • Defective relay • Defective connector on engine side	★Replacement ★Replacement ★Check and repair looseness and pullout of connector.
Preheating monitor does not turn on.	• Defective wiring • Defective heater relay • Defective monitor	★Inspection and repair ★Replacement ★Replacement
You do not feel warm when you touch the outside of the electric heater by hands.	• Defective wiring • Break in electric heater • Malfunction of heater relay	★Inspection and repair ★Replacement ★Replacement



Abnormal Phenomenon	Major cause(s)	Remedy
Travelling alarm does not sound when travelling lever is operated.	<ul style="list-style-type: none"> <li>• Defective wiring</li> <li>• Defective alarm</li> <li>• Defective PPC pressure sensor</li> </ul>	<ul style="list-style-type: none"> <li>★Check and repair looseness, pullout and break of connector</li> <li>★Replacement</li> <li>★Replacement</li> </ul>
Rear view camera shows nothing.	<ul style="list-style-type: none"> <li>• Defective wiring</li> <li>• Defective camera</li> <li>• Defective monitor</li> </ul>	<ul style="list-style-type: none"> <li>★Check and repair looseness, pullout and break of connector</li> <li>★Replacement</li> <li>★Replacement</li> </ul>





### 8.4.2 MACHINE BODY COMPONENTS

- Make sure that you contact us or our sales service agency for the actions marked with ★ in the table.
- Ask us or our sales service agency for repair if you suspect any other abnormalities or causes than those given below.

Abnormal Phenomenon	Major cause(s)	Remedy
Travelling speed, slewing speed, boom and hook block operation speed too slow	<ul style="list-style-type: none"> <li>• Insufficient hydraulic oil</li> </ul>	<ul style="list-style-type: none"> <li>• Refill with hydraulic oil to the specified oil level, referring to the section "Check before operation".</li> </ul>
Abnormal noise from pump (Air suction)	<ul style="list-style-type: none"> <li>• Clogging in the hydraulic oil tank strainer and element, lack of oil</li> </ul>	<ul style="list-style-type: none"> <li>• See "Periodic check" and clean.</li> </ul>
Hydraulic oil temperature too high	<ul style="list-style-type: none"> <li>• Looseness of fan belt</li> <li>• Contamination of oil cooler</li> <li>• Insufficient hydraulic oil</li> </ul>	<ul style="list-style-type: none"> <li>• See "Periodic check" to check tension and replace fan belt.</li> <li>• See "Periodic check" and clean.</li> <li>• Refill with hydraulic oil to the specified oil level, referring to the section "Check before operation".</li> </ul>
Tracks coming off	<ul style="list-style-type: none"> <li>• Tracks too loose</li> </ul>	<ul style="list-style-type: none"> <li>• See "Irregular maintenance" and adjust the tension.</li> </ul>
Abnormal wear on the sprockets		



### 8.4.3 ENGINE COMPONENTS

- Make sure that you contact us or our sales service agency for the actions marked with ★ in the table.
- Ask us or our sales service agency for repair if you suspect any other abnormalities or causes than those given below.

Abnormal Phenomenon	Major cause(s)	Remedy
Engine oil pressure error is displayed while the engine is in operation.	<ul style="list-style-type: none"> <li>• Lack of oil in oil pan (air suction)</li> <li>• Oil filter cartridge clogged</li> <li>• Defective fastening of oil pipe and joints, oil leaks due to breakage</li> <li>• Defective engine oil pressure sensor</li> <li>• Defective monitor</li> </ul>	<ul style="list-style-type: none"> <li>• See "Check before operation" and adjust oil level to appropriate one.</li> <li>• See "Periodical Maintenance" to check, or replace.</li> <li>★ Inspection and repair</li> <li>★ Replacement</li> <li>★ Replacement</li> </ul>
Steam spouts out from the upper part (pressure valve) of radiator.	<ul style="list-style-type: none"> <li>• Lack of coolant</li> <li>• Water leakage from the cooling line</li> <li>• Looseness of fan belt</li> </ul>	<ul style="list-style-type: none"> <li>• See "Check before operation" and refill coolant.</li> <li>★ Inspection and repair</li> <li>• See "Periodical Maintenance" to adjust, or change the belt.</li> </ul>
Engine coolant temperature error is displayed.	<ul style="list-style-type: none"> <li>• Accumulation of dust and fur in cooling system</li> <li>• Radiator fin clogged</li> <li>• Defective thermostat</li> <li>• Looseness of radiator cap (during work at elevation)</li> <li>• Defective monitor</li> </ul>	<ul style="list-style-type: none"> <li>• See "Irregular Maintenance" to change coolant and clean inside of cooling system.</li> <li>• See "Periodical Maintenance" to check, clean or repair.</li> <li>★ Replacement</li> <li>• Tighten cap or replace packing.</li> <li>★ Replacement</li> </ul>



Abnormal Phenomenon	Major cause(s)	Remedy
Engine does not start even after the starter key is turned	<ul style="list-style-type: none"> <li>• Insufficient fuel</li> <li>• Mixing of air in fuel system</li> <li>• Defective fuel pump and nozzle</li> <li>• Starter motor turning slow</li> <li>• Preheating monitor does not turn on.</li> <li>• Defective compression</li> </ul>	<ul style="list-style-type: none"> <li>• See "Check before operation" and refuel</li> <li>• See "Periodical Maintenance" to repair the area where air is mixed</li> <li>★Replace pump or nozzle</li> <li>• See "Electrical Components"</li> <li>• See "Electrical Components"</li> <li>★Adjustment of valve clearance</li> </ul>
Exhaust gas color turns into white or bluish	<ul style="list-style-type: none"> <li>• Excessive oil in oil pan</li> <li>• Defective fuel</li> </ul>	<ul style="list-style-type: none"> <li>• See "Check before operation" and adjust oil level to appropriate one</li> <li>• Change to specified fuel</li> </ul>
Exhaust gas color sometimes turns into black	<ul style="list-style-type: none"> <li>• Air cleaner element clogged</li> <li>• Defective nozzle</li> <li>• Defective compression</li> <li>• Defective turbocharger</li> </ul>	<ul style="list-style-type: none"> <li>• See "Irregular Maintenance" for cleaning or replacement of the parts</li> <li>★Replacement of nozzle</li> <li>★Adjustment of valve clearance</li> <li>★Cleaning and replacement</li> </ul>
Combustion sound sometimes breathes	<ul style="list-style-type: none"> <li>• Defective nozzle</li> </ul>	<ul style="list-style-type: none"> <li>★Replacement of nozzle</li> </ul>
Abnormal noise is generated (combustion or mechanical)	<ul style="list-style-type: none"> <li>• Use of low-grade fuel</li> <li>• Overheat</li> <li>• Breakage of inside of muffler</li> <li>• Valve clearance excessive</li> </ul>	<ul style="list-style-type: none"> <li>• Change to specified fuel</li> <li>• See aforementioned "Engine coolant temperature error is displayed"</li> <li>★ Replacement of muffler</li> <li>★Adjustment of valve clearance</li> </ul>
The engine stops during operation	<ul style="list-style-type: none"> <li>• Clogging of fuel pre-filter and main filter</li> <li>• Defective engine and fuel circuit</li> </ul>	<ul style="list-style-type: none"> <li>• Replacement of filter cartridge</li> <li>★Inspection and repair</li> </ul>



#### 8.4.4 MOMENT LIMITER COMPONENTS

- Make sure that you contact us or our sales service agency for the actions marked with ★ in the table.
- Ask us or our sales service agency for repair if you suspect any other abnormalities or causes than those given below.

#### NOTES

When an error code is displayed on the monitor, see "Operation 2.1.2 [2] List of Error Codes".

★When display of moment limiter monitor display is normal

Abnormal Phenomenon	Major cause(s)	Remedy
The crane operation does not stop even in an overload state.	Defective communication, defective controller	★Inspection of communication circuit, replacement of controller
	Defective cancel switch	★Inspection and replacement of cancel switch
	Defective solenoid valve spool	★Disassembly repair or replacement of solenoid valve
	Short circuit of emergency power supply circuit	★Inspection and replacement of solenoid valve
Extension, hoisting and lowering do not operate when not in an overload state	Defective wiring between controller and solenoid valve	★Inspection, repair or replacement of wiring between controller and solenoid valve
	Defective solenoid valve coil or spool	★Disassembly repair or replacement of solenoid valve



### 8.4.5 OVERWINDING PREVENTION DEVICE

- Make sure that you contact us or our sales service agency for the actions marked with ★ in the table.
- Ask us or our sales service agency for repair if you suspect any other abnormalities or causes than those given below.

★When no operation stops in an overwinding state

Abnormal Phenomenon	Major cause(s)	Remedy
When extending or hoisting operation is performed, the operation does not stop even in an overwinding state although the buzzer sounds.	Short circuit of emergency power supply circuit	★Inspection and replacement of solenoid valve
	Defective overwinding cancel switch	★Inspection and replacement of overwinding cancel switch
	Defective ground	★Replacement of ground
When extending or hoisting operation is performed, the buzzer does not sound and the operation does not stop either even in an overwinding state.	Defective overwinding detector	★Inspection and replacement of overwinding detector

★When extension or hoisting does not operate even when not in an overwinding state

Abnormal Phenomenon	Major cause(s)	Remedy
When extending or hoisting operation is performed, the buzzer sounds and the operation is not performed even when not in an overwinding state.	Defective overwinding detector	★Inspection and replacement of overwinding detector
	Damage or entanglement of overwinding detecting wire	★Inspection, repair and replacement of overwinding detecting wire
	Damage of overwinding detecting weight	★Inspection and replacement of overwinding detecting weight
	Defective wiring between controller and overwinding detector	★Inspection, repair or replacement of wiring between controller and overwinding detector
When extending or hoisting operation is performed, the operation is not performed even when not in an overwinding state. However, the buzzer does not sound.	Defective solenoid valve coil or spool	★Disassembly repair or replacement of solenoid valve
	Defective wiring between controller and solenoid valve	★Inspection, repair or replacement of wiring between controller and solenoid valve



**This Page Intentionally Left Blank.**



# INSPECTION AND MAINTENANCE

1. PRECAUTIONS FOR MAINTENANCE	226
2. BASIC MAINTENANCE	228
3. LEGAL INSPECTION	232
4. PERIODIC REPLACEMENT OF CRITICAL PARTS	233
5. CONSUMABLES	234
6. OTHER REPLACEMENT PARTS	235
7. USE OF FUEL AND LUBRICATING OIL	236
8. STANDARD TIGHTENING TORQUE	238
9. LIST OF ITEMS FOR INSPECTION AND MAINTENANCE	239
10. MAINTENANCE PROCEDURES	241
11. AIR BLEEDING OF HYDRAULIC CIRCUITS	284
12. RELIEVING INTERNAL PRESSURE OF HYDRAULIC CIRCUIT	288
13. ATTACHING/DETACHING SINGLE-FALL HOOK	289



## 1. PRECAUTIONS FOR MAINTENANCE

Thorough understanding of the inspection and maintenance items is required to perform efficient inspection and maintenance that contributes to safe use of this machine.

### **⚠ WARNING**

- **Do not perform any inspection or maintenance that is not described in this manual. Potential serious accident or machine failure may occur if it is performed at the discretion of the individual. If the severity of a failure or malfunction cannot be determined, contact us or our sales service agent to request repair.**
- **In the event that a failure or malfunction is encountered while the machine is in operation or found during an inspection, report it to your employer or supervisor immediately. Contact us or our sales service agency to request repair accordingly.**
- **Inspection and maintenance should be performed with the machine placed on a level and strong footing.**

#### **[1] CHECK THE SERVICE METERS**

Read the service meters every day to check for any maintenance item that has reached the obligatory maintenance period.

#### **[2] USE GENUINE PARTS FOR REPLACEMENT**

Always use Maeda genuine parts as specified in the parts catalog for part replacement.

#### **[3] USE PURE GREASE**

Always use Maeda pure grease. The viscosity of grease must conform to specifications according to ambient temperature.

#### **[4] USE CLEAN OIL AND GREASE**

Always use clean oil or grease, and keep in a secure container to reduce contact with impurities.

#### **[5] USING CLEAN WINDOW WASHER LIQUID**

Use the window washer liquid for automobiles and keep it free from any contamination such as dirt and dust.

#### **[6] KEEP THE MACHINE CLEAN**

Wash the machine clean to facilitate the detection of a malfunction. Especially keep the grease nipple, breather, and oil level gauge (oil access door) clean to prevent impurities from entering the machine.

#### **[7] PAYING ATTENTION TO WATER AND OIL TEMPERATURES**

Drainage, drain oil, and exhaust filter will be at elevated temperatures immediately after the machine is stopped. Replace drainage, drain oil, and filter only after their temperature has dropped.

On the contrary, if the oil is cold, raise the temperature of the oil to approx. 20 to 40°C).

#### **[8] INSPECTING DRAIN OIL AND FILTER**

For replacement of oil and filter, check the drained oil and used filter to ensure that no significant amount of metal powder or foreign objects are found.

#### **[9] CAUTIONS IN ADDING OIL**

Do not remove the strainer to lubricate if it is attached to the lubrication opening.

#### **[10] PROTECT OIL FROM IMPURITIES**

Avoid dust when inspecting and replacing the oil to keep impurities out of the oil.

#### **[11] ATTACHING A WARNING TAG**

When draining coolant and oil, always pull out the starter switch key to prevent accidental engine ignition. Also, attach a warning tag to the work machine operating lever.

#### **[12] OBSERVE SAFETY PRECAUTIONS**

Safety precautions provided on the machine should always be followed when using the machine.





**[13] CAUTIONS FOR WELDING REPAIR**

- Make sure the machine is turned off. (Turn the starter switch to the "OFF" position.)
- Do not continuously apply 200V or higher.
- Ground the machine within 1m from the welding point.
- Remove the negative (-) terminal of the battery.
- Make sure no sealing or bearing is present between the welding point and the grounding point. Potential damage to sealing may occur due to sparks if disregarded.
- Do not ground around the boom pin or the hydraulic cylinder. Potential damage to a plated section may occur due to sparks if disregarded.

**[14] WATCH FOR FLAME**

Always clean the parts with non-combustible cleaning agent or diesel fuel.

Keep the machine away from flame when using diesel fuel.

**[15] KEEP THE ATTACHMENT SURFACE CLEAN**

Be sure to clean the attachment surface after removing a part to which the O-ring and gasket sealing are attached.

Replace the part with a new one with the O-ring and gasket re-attached.

**[16] EMPTY YOUR POCKETS**

Always empty your pockets before performing inspection and maintenance of the machine in a downward direction with the cover opened.

**[17] ASSURE SAFE RUBBER TRACK**

When performing crane operation in a rocky location, make sure of no damage to the rubber track and no looseness, cracks or abrasion of bolts and nuts. Loosen the tension of the crawler tread more than usual.

**[18] CAUTIONS FOR MACHINE WASH**

- Do not direct a jet of steam to the electrical parts and connector.
- Keep the operation panel dry.
- Wash the machine with a clean cloth, rinsing off dirt and dust.

**[19] PRE- AND POST-WORK INSPECTION**

Before performing crane operation in muddy water, rain, snow or on the coast, always check for loose fitting plugs and valves. Post-operation inspection requires checks to all units for cracks and damage; looseness and falling of bolts and nuts, after the machine has been washed.

Carry out early greasing. Grease the operating pin that enters the muddy water on a daily basis.

**[20] CAUTIONS FOR WORKING ON A DUSTY SITE**

The following precautions should be observed when working on a dusty site.

- When inspecting and replacing the oil, move the machine to a clean place to avoid dust and keep impurities out of the oil.
- Frequently check the air cleaner for clogging.
- Clean the radiator core at an early stage to prevent it from being clogged.
- Clean and replace the fuel filter in a timely manner.
- Be sure to clean the electrical parts, especially the starter and alternator, to protect them from dust.

**[21] DO NOT MIX DIFFERENT BRANDS OF OIL**

Never mix oil of different brands and different types under any circumstance.

Replace the oil entirely when replenishing a different type of oil.

Always use Maeda genuine parts for part replacement.



## 2. BASIC MAINTENANCE

### [1] OIL HANDLING

- Oil is used under extremely harsh conditions (high temperature, high pressure) in the engine and working device, which causes the oil to undergo deterioration with operating time. Always use oil that meets requirements such as grade and operating temperature defined in the operation manual.

Be sure to perform periodic replacement of oil irrespective of contamination in the oil.

- Oil is equivalent to human blood. Exercise due caution when handling oil, keeping impurities (such as water, metal powder or dust) out of oil. Most of mechanical failures are attributed to intrusion of impurities.

Extra caution is required to prevent impurities entering during machine storage and lubrication.

- Do not mix oil with another oil of a different grade or brand.

- Oil lubrication must conform to the designated quantity of oil.

Failure to lubricate with an adequate quantity can lead to a machine failure.

- In the event that oil used in the working device turns cloudy, potential intrusion of moisture or air into the oil may be considered.

Contact us or our sales service agent.

- When replacing oil, always replace the relevant filter as well.

- Do not use any other hydraulic oil that is not recommended by us. Failure to follow the instruction may cause the filters to get clogged. A small amount of oil remaining in piping and cylinders does not cause problems even when mixed with other oil.

### [2] FUEL HANDLING

#### **CAUTION**

**For the fuel, be sure to use diesel fuel.**

**For the engine of this Machine, an electronically controlled high pressure injection unit is used to obtain good fuel consumption and exhaust gas characteristics. Since this unit is of high part precision and lubricating performance, the use of a low viscosity fuel having a low lubricating characteristic may markedly spoil the durability.**

- The fuel pump is a precision part that becomes inoperative if fuel containing moisture or impurities is used. Extra caution is required to prevent impurities from entering during machine storage and lubrication.

- Do not remove the strainer when replenishing fuel.

- Always use oil that meets requirements such as grade and operating temperature defined in the operation manual.

- Ensure that the fuel tank is filled up after finishing the days work to prevent condensation of the humid air inside the fuel tank that will result in intrusion of moisture.

- Drain deposits and water out of the fuel tank before starting the engine or approximately 10 minutes after fuel replenishment.

- The air should be released from the circuit when the machine runs out of fuel or when the fuel filter is replaced.

- Clean the tank and fuel system if any foreign substances enter the fuel tank.



### [3] STOCKING AND STORAGE OF OIL AND FUEL

- Store oil and fuel indoors to keep impurities such as moisture or dust out of them.
- When storing oil and fuel in drums for a long time, line the drums horizontally aligning the drum bungs below the liquid level (to store them away from moisture). Be sure to cover the drums with a waterproof sheet if unavoidably storing them outside.
- To prevent deterioration of oil and fuel resulting from long-term storage; employ the first-in first-out system for using oil and fuel.

### [4] GREASE HANDLING

- Grease is designed to prevent the joints from rattling and making noise.
- A nipple that is not described in the Periodic Maintenance chapter is used for overhauls, which requires no grease replenishment.  
Grease the nipple if long-term use hinders its smoothness.
- Thoroughly wipe off old grease squeezed out after greasing.  
Extra care is required to wipe a part that the adhesion of sands and dust accelerates the wearing away of the rotating part.

### [5] FILTER HANDLING

- A filter is an extremely important part that keeps major equipment free from impurities in oil, fuel, and the air circuit, which prevents an associated failure. Periodic replacement of the filter is required in accordance with the Operation Manual.  
The replacement period should be shortened if commensurate with harsh operating environments or the amount of oil and fuel (containing sulfur) used.
- Do not reuse any washed filters (cartridge-typed ones) under any circumstances.
- After replacing an oil filter, check the used filter for any metal powder.  
If metal powder is found on the used filter, contact us or our sales service agent.
- Always unpack the replacement filter prior to its use.
- Always use Maeda genuine filters.

### [6] COOLANT HANDLING

- The river water contains a large amount of calcium and impurities. Use of the river water results in accumulation of water stain in the engine and radiator, which causes heat exchange error leading to overheating.  
Do not use non-drinkable water.
- Always use antifreeze following precautions stated in the Operation Manual.
- Keep antifreeze from flame. Antifreeze is a flammable solution.
- The mixing proportion of antifreeze varies with outside air temperature.  
For the mixing proportion, refer to the descriptions under "Maintenance 10.3 IRREGULAR MAINTENANCE [4] CLEANING ENGINE COOLING SYSTEM".
- In the event of overheating, replenish coolant with the engine cold.
- Shortage of the coolant may cause overheating and corrosion of the radiator attributed to air in the system.



### **[7] ELECTRICAL PARTS HANDLING**

- A current leakage is developed if the electrical parts are wet or have a damaged coating, which causes the machine to become out of order and malfunction.
- Inspection and maintenance include the checking of belt tension, belt damage, and battery electrolyte level.
- Never remove and disassemble equipment (electrical parts) from the machine.
- Only optional electrical parts that accompany the machine can be installed.
- Keep the electrical parts away from water when the machine is washed or used in the rain.
- When using the machine in coastal areas, keep the electrical parts free of water and impurities to prevent corrosion.

### **[8] HYDRAULIC EQUIPMENT HANDLING**

- Hydraulic equipment will be at elevated temperatures during and immediately after operation. Hydraulic equipment operates under high pressure.

The following precautions should be observed when performing inspection and maintenance of hydraulic equipment.

- Place the machine in travel position on a level surface to inhibit the application of pressure to the cylinder circuit.
- Be sure to stop the engine.
- Hydraulic oil and lubricating oil will be at elevated temperatures and high pressure immediately after equipment comes to a stop. Perform inspection and maintenance only after the oil drops in temperature, for safety. An internal pressure may be exerted despite temperature drop. When removing the plugs, screws and hose joints, stand aside and provide gradual loosening to decompress.
- Be sure to release the pressure by removing the air from the hydraulic oil tank before performing inspection and maintenance of the hydraulic circuit.
- Inspection and maintenance include hydraulic oil level check and replacement of the filters and hydraulic oil.
- Check the O-ring for scratches when removing the high-pressure hose. If scratches are found, replace it.
- Bleeding the air from the hydraulic circuit is required after the following tasks are performed: replacement and cleaning of the hydraulic oil filter element and strainer, repair and replacement of hydraulic equipment, and hydraulic piping removal.

### **[9] HANDLING THE AIR-CONDITIONER**

- If the refrigerant of the air-conditioner get into the eyes, loss of sight may occur and if it comes into contact with skin, it gives rise to frostbite. Never loosen parts of the cooling circuit.
- Do not discharge refrigerant into the atmosphere. When recovering or filling a fluorocarbon refrigerant, consult with our sales service agency or consign the work to a Class 1 fluorocarbon refrigerants filling and recovering contractor registered by the competent authorities.
- When conducting the maintenance servicing of the air-conditioner, follow the Fluorocarbon Refrigerants Emission Regulating Act.
- Users (possessors) of the Machine are obligated to conduct periodic inspections by the Fluorocarbon Refrigerants Emission Regulating Act. Inspect once every three months. Even when the air-conditioner is not used during off season, the inspection is required.

**Check Item**

- Abnormal vibration and abnormal operation noise of the compressor
- Oil oozing out on and around the compressor
- Scratches, corrosion, rust and other blemishes on the compressor
- Frosting of air-conditioner heat-exchanger in the cabin

**Storage of inspection and maintenance servicing history**

Keep the records of administrator's name, location of the machine, initial amount of Freon filled, and dates of inspection, repair, refrigerant recovery, and refrigerant filling until the machine is disposed of.



### 3. LEGAL INSPECTION

If periodic inspection for machine safety assurance is stipulated by laws and regulations of your country, perform inspection complying with the inspection items listed below.

1. Make sure no abnormal event is present in the safety devices.
2. Check the hoisting accessories including a hook block for any abnormalities.
3. Check the winch wire rope end and wire clip for damage.
4. Replace the wire rope promptly if it is damaged.
5. Check the hydraulic hose for oil leaks and friction flaws on the surface. Replace the hose if a surface flaw is detected.
6. Check the structural part including the boom for cracks and deformations.
7. Check the mounting bolts and joints for looseness and falling off.
8. Check if the crane perform proper operation and stop during extending, retracting, raising, lowering, and slewing.

If check finds a malfunction, contact us or our sales service agency.



## 4. PERIODIC REPLACEMENT OF CRITICAL PARTS

To assure prolonged and safe use of the Machine, be sure to conduct the periodic replacement of parts listed on the table of critical parts especially related to safety and fire.

Since these parts are prone to degradation of material by aging and abrasion and the extent of the degradation and deterioration cannot be determined, it is required to replace them even if no abnormality is found in order to maintain their correct functions all the time.

If any abnormality is found in any of these parts, it is required to replace it even if it is before the predetermined time for replacement.

As to the hoses, if any sign of degradation such as deformation or cracking of the clamp is detected, replace the clamp at the same time.

Concurrently, conduct the periodic inspections indicated in the following table of the hydraulic hoses other than the parts of periodic replacements, and if any abnormality is found, execute retightening or replacement.

- In parallel to the replacement of hoses, replace the O-rings and gaskets as well.
- Contact us or our sales service agency for the replacement of critical parts.
- At a regular inspection indicated in the following table, conduct the inspection of hydraulic hoses and fuel hoses.

Classification of Inspection	Check Item
Daily Checkup (before starting work)	Oil leakage from the joint and caulking of fuel hoses and hydraulic hoses
Monthly Inspection	Oil leakage from the joint and caulking of fuel hoses and hydraulic hoses Damage of fuel hoses and hydraulic hoses (cracking, abrasion and tear)
Specific Voluntary Inspection (annual inspection)	Oil leakage from the joint and caulking of fuel hoses and hydraulic hoses Interference, collapse, aging, twist and damage (cracking, abrasion and tear) of fuel hoses and hydraulic hoses

### List of Critical Parts

No.	Periodically Replaced Parts	Q'ty	Replacement cycle
1	Fuel hose (fuel tank - prefilter - pump - filter - engine)	4	Every 2 years or every 4000 hours, whichever falls first
2	Fuel return hose (return - fuel tank)	1	
3	Hose for turbo lubrication	1	
4	Engine oil filter hose (engine - oil filter)	2	
5	Hydraulic hose (pump outlet - operation valve)	4	
6	Hydraulic hose (boom telescoping cylinder)	2	
7	Hydraulic hose (boom derricking cylinder)	4	
8	Hydraulic hose (winch motor)	2	
9	Hydraulic hose (slewing motor)	2	
10	Hydraulic hose (pump inlet)	1	
11	Air-conditioner heater hose	2	
12	Accumulator (for operation circuit)	1	
13	Seat belt	1	Replace every 3 years
14	Engine high pressure tubing clamp	1 set	Every 8000 hrs.
15	Fuel splash preventing cap	1 set	



## 5. CONSUMABLES

Replace consumables such as a filter element and wire rope upon periodic maintenance or prior to the wear limit.

Proper replacement of consumables delivers increased economy in machine use.

Always use Maeda genuine parts for part replacement.

See the parts catalogue for part numbers when ordering parts.

### [LIST OF CONSUMABLES]

Item	Replacement cycle
Engine oil filter	Every 500 hrs.
Fuel pre-filter	Every 500 hrs.
Hydraulic oil tank breather	Every 500 hrs.
Fuel feed pump filter	Every 500 hrs.
Main fuel filter	Every 500 hrs.
Hydraulic oil return filter	Every 1000 hrs.
Hydraulic oil line filter	Every 1000 hrs.
Air cleaner	As required
Cylinder packing	★ Every 3 yrs.
Boom slide plate	Every 3 yrs.
Wire rope for hoisting	As required or every 3 years
Wire rope for boom extension	As required or every 3 years
Wire rope for boom retraction	As required or every 3 years

★The cycles marked with a “★” in Replacement cycle include a halt (non-working) period.

★Contact us or our sales service agent located nearest to you for part replacement.





## 6. OTHER REPLACEMENT PARTS

Since part numbers may be changed as a consequence of product improvement, check with us or our sales agency for the latest part number by referring to the machine number.

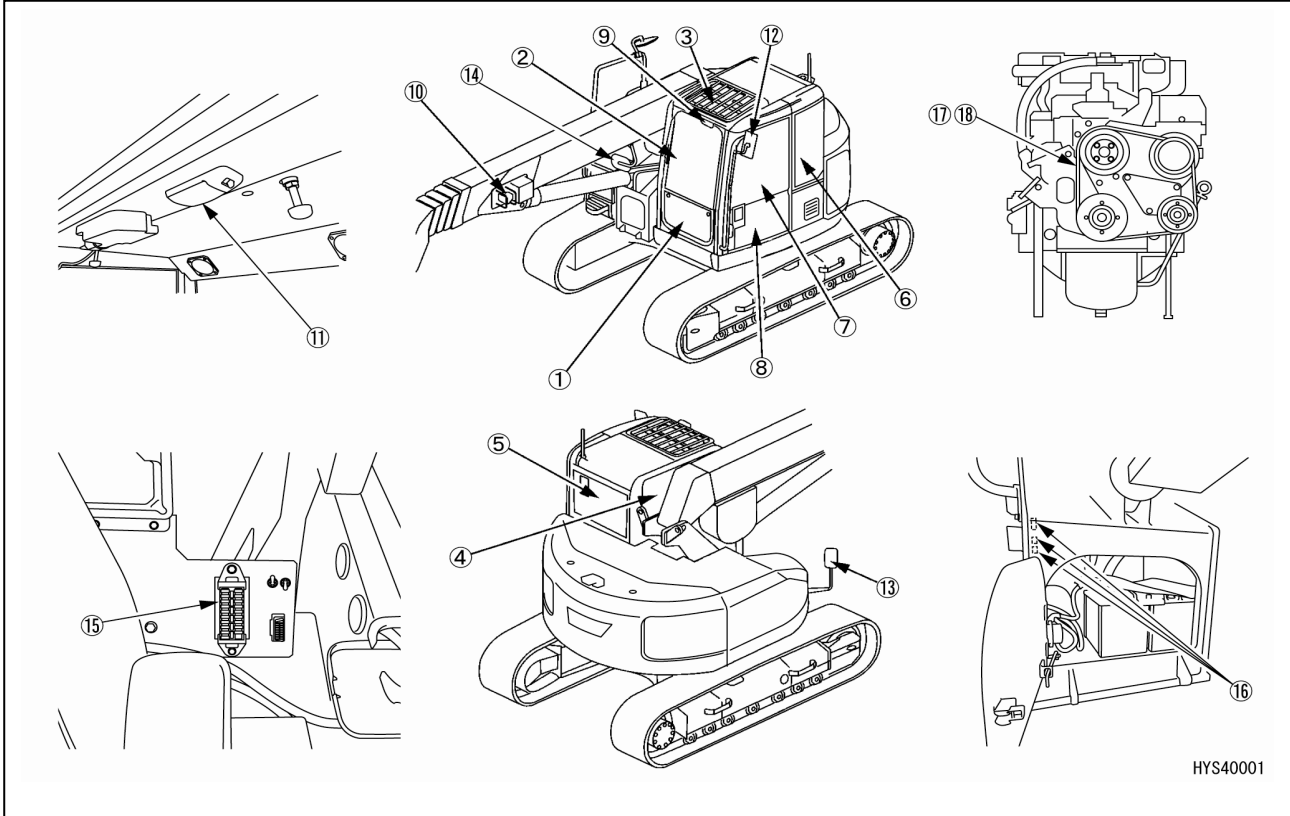

No.	Part Name	Q'ty
1	Glass	1
2	Glass	1
3	Glass	1
4	Glass	1
5	Glass	1
6	Glass	1
7	Glass	1
8	Glass assembly	1
	• Glass	1
9	Working lights assembly	1
	• Light bulb (70W)	1
10	Working lights assembly	1
	• Light bulb (70W)	1
11	Room lamp	1
	• Light bulb (10W)	1

No.	Part Name	Q'ty
12	Mirror	1
13	Mirror	1
14	Winch mirror	1
15	Fuse (30A)	1
	Fuse (20A)	2
	Fuse (15A)	1
	Fuse (10A)	7
16	Fuse (5A)	7
	Fusible link (120A)	1
	Fusible link (60A)	1
	Fusible link (45A)	2
17	Fan belt	1
	Fusible link (30A)	1
18	Air-conditioner belt	1



## 7. USE OF FUEL AND LUBRICATING OIL

- To keep the Machine in the best possible condition for a long period of time, we recommend the use of our specified oil, grease and coolant as given in this instruction manual.
- Using product other than those specified may give rise to the loss of service life or excessive abrasion of the engine, power train and cooling system.
- Some of the oil additives on the market may deteriorate the oil performance. We do not recommend any of the oil additives available on the market.
- Depending on the air temperature, select the best suited grades of oil to the respective temperatures as indicated in the following table.
- A specified oil quantity is defined as a total quantity of oil including that for unit piping, and a replacement oil quantity is defined as a quantity of oil to be replaced at inspection and maintenance.
- When starting the engine at temperatures of 0°C or lower, always use the recommended multigrade oil, even if daytime temperature raises.

### 7.1 USE OF FUEL AND LUBRICATING OIL ACCORDING TO TEMPERATURES

Depending on the air temperature, select the best suited ones given below:

Oiling Area	Oil Type	Temperature-dependent Mode of Use (°C)		Recommended Authentic Oil
		Minimum	Maximum	
Engine oil pan	Engine oil	-30	30	SAE 10W30DH-2
		-30	40	★ SAE 10W40DH-2
		-15	40	SAE 15W40DH-2
Hydraulic oil system	Hydraulic oil (synthetic lubrication oil)	-30	40	SAE 5W30
	Power line oil	-20	40	★ SAE 10W
	Hydraulic oil	-20	40	ISO VG46
Winch motor reducer casing	Gear oil	-30	40	★ SAE 90 GL4
Travelling motor reducer casing				
Cooling system	Coolant Diluting water (Note 2)	-30	40	★ LLC
Fuel tank	Diesel fuel			

★: Default on factory shipment



Oiling Area	Specified oil quantity (l)	Replacement oil quantity (l)
Engine oil	11.0	10.0
Travelling motor reducer casings (1 left and 1 right)	2.1	2.1
Hydraulic oil system	125	81
Winch motor reducer casing	1.8	1.8
Cooling system	12.0	---
Fuel tank	140	---

### CAUTION

**Always use diesel fuel.**

**For the engine of this Machine, an electronically controlled high pressure injection unit is used to obtain good fuel consumption and exhaust gas characteristics. Since this unit has high precision parts and needs good lubricating performance, the use of a low viscosity fuel having a low lubricating characteristic may markedly spoil the durability.**

Note 1: When preservation work of the environment is of importance, typically river construction work, marine and sea shore work, forestry work and the like, use of biological hydraulic oils and greases is recommended. For details of using them, contact us or our sales service agency.

Note 2: On the coolant

(1) The coolant is required to perform important functions such as an anticorrosion agent as well as an antifreezing agent for a cooling system.

Thus, use this coolant continuously even in areas where anti-freezing characteristic is not required.

Use of any other coolants than our authorized coolant (LLC) is in principle not recommended. Otherwise a serious failure may occur in the cooling system including the engine.

(2) For the mixing proportion of coolant and diluting water, refer to the descriptions under "Maintenance 10.3 [4] Cleaning the Inside of Engine Cooling System".

On factory shipment, the coolant is added with our genuine coolant (LLC) at a proportion of 30% or more, there is no need alter the concentration unless below a temperature of -10°C. If the temperature goes below -10°C, adjust the coolant concentration in accordance with the proportion table given under "MAINTENANCE 10.3 IRREGULAR MAINTENANCE [4] CLEANING ENGINE COOLING SYSTEM".

(3) To maintain the anticorrosion performance of the coolant, always keep the concentration at 30% or higher.



## 8. STANDARD TIGHTENING TORQUE

### 8.1 STANDARD TIGHTENING TORQUE LIST

#### CAUTION

**Tightening at a torque beyond the specified range will cause damage to tightened parts or loosening, resulting in failure and malfunction of the Machine. Pay adequate attention to the tightening operation.**

Torque the metric bolts and nuts that have no specific indication, to the values shown in this table.

Adequate tightening torque is determined with respect to a width across flat (b) of a bolt or nut.

Nominal size a (mm)	Width across flat b (mm)	Tightening torque {N·m (kgf·m)}	
		Target value	Tolerance
6	10	13.2 (1.35)	11.8 to 14.7 (1.2 to 1.5)
8	13	31.0 (3.20)	27.0 to 34.0 (2.8 to 3.5)
10	17	66.0 (6.70)	59.0 to 74.0 (6.0 to 7.5)
12	19	113 (11.5)	98.0 to 123 (10.0 to 12.5)
14	22	172 (17.5)	153 to 190 (15.5 to 19.5)
16	24	260 (26.5)	235 to 285 (23.5 to 29.5)
18	27	360 (37.0)	320 to 400 (33.0 to 41.0)
20	30	510 (52.3)	455 to 565 (46.5 to 58.0)
22	32	688 (70.3)	610 to 765 (62.5 to 78.0)
24	36	883 (90.0)	785 to 980 (80.0 to 100)
27	41	1295 (132.5)	1150 to 1440 (118 to 147)
30	46	1720 (175.0)	1520 to 1910 (155 to 195)
33	50	2210 (225.0)	1960 to 2450 (200 to 250)
36	55	2750 (280.0)	2450 to 3040 (250 to 310)
39	60	3280 (335.0)	2890 to 3630 (295 to 370)

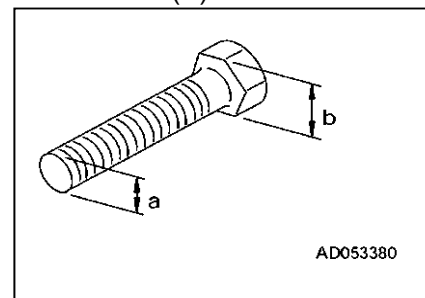

Tighten hoses with the respective values of torque specified in the table below:

Nominal size No.	Width across flat a (mm)	Tightening torque {N·m (kgf·m)}	
		Target value	Tolerance
02	19	44 (4.5)	35 to 4 (3.5 to 5.5)
03	22	74 (7.5)	54 to 93 (5.5 to 9.5)
	24	78 (8.0)	59 to 98 (6.0 to 10.0)
04	27	103 (10.5)	84 to 132 (8.5 to 13.5)
05	32	157 (16.0)	128 to 186 (13.0 to 19.0)
06	36	216 (22.0)	177 to 245 (18.0 to 25.0)

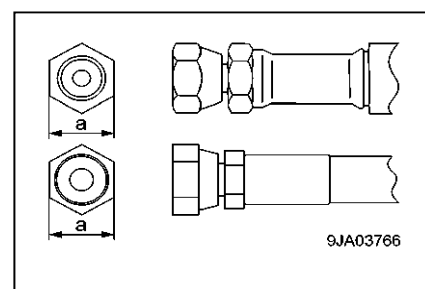



## 9. LIST OF ITEMS FOR INSPECTION AND MAINTENANCE

Inspection and maintenance items	Page
<b>10.1 INITIAL 500-HOUR MAINTENANCE (Only the 1st maintenance of a new machine)</b>	241
[1] OIL REPLACEMENT IN WINCH REDUCTION GEAR CASE	241
<b>10.2 PRE-OPERATION INSPECTION</b>	241
<b>10.2.1 Inspection before starting engine (visual inspection) (Refer to item "Operation 3.1.1".)</b>	130
[1] INSPECTION AROUND CRANE	131
[2] INSPECTION OF WIRE ROPE	131
[3] INSPECTION OF HOOK BLOCK	131
[4] INSPECTION AROUND UPPER SLEWING BODY	132
[5] INSPECTION OF CABIN	132
[6] INSPECTION AROUND CARRIER	132
<b>10.2.2 Inspection before starting engine (Refer to item "Operation 3.1.2".)</b>	133
[1] CHECKING/REFILLING ENGINE COOLANT	133
[2] CHECKING/REFILLING OIL LEVEL IN ENGINE OIL PAN	133
[3] CHECKING/REFUELING FUEL LEVEL IN FUEL TANK	135
[4] CHECKING/REFILLING OIL LEVEL IN HYDRAULIC OIL TANK	136
[5] INSPECTION OF DUST INDICATOR	137
[6] INSPECTING WATER SEPARATOR AND DRAINING CONTAMINANT WATER/DEPOSITS	138
[7] DRAINING CONTAMINANT WATER/DEPOSITS IN FUEL TANK	139
[8] INSPECTING ELECTRIC WIRING	140
[9] CHECKING WORKING LAMP	140
[10] CHECKING HORN FOR OPERATION	140
[11] ADJUSTING THE OPERATOR'S SEAT	141
[12] ADJUSTMENT OF MIRRORS	142
[13] ADJUSTING MIRROR FOR CHECKING IRREGULAR WINDING	143
[14] ANGLE ADJUSTMENT OF REAR VIEW CAMERA	144
[15] CHECKING BATTERY ELECTROLYTE LEVEL	145
<b>10.2.3 Inspection before starting engine (Refer to item "Operation 3.1.3".)</b>	147
[1] CHECKING EASE OF ENGINE CRANKING AND ABNORMAL NOISE	147
[2] CHECKING LOW SPEED AND ACCELERATION STATE OF ENGINE	147
[3] CHECKING ENGINE EXHAUST GAS COLOUR, ABNORMAL NOISE AND VIBRATION	147
[4] CHECKING CRANE OPERATIONS	148
[5] CHECKING OVER HOIST PREVENTION DEVICE	148
[6] INSPECTION OF MOMENT LIMITER	148
<b>10.3 IRREGULAR MAINTENANCE</b>	242
[1] REPLACEMENT OF WINCH WIRE ROPE	242
[2] CHECKING/ADJUSTING MAIN BOOM TELESCOPING WIRE ROPE	247
[3] CHECKING/CLEANING/REPLACING AIR CLEANER	248
[4] CLEANING ENGINE COOLING SYSTEM	250
[5] CHECKING AND RE-TIGHTENING RUBBER TRACK BOLTS	253
[6] CHECKING/ADJUSTING RUBBER TRACK TENSION	253
[7] CHECKING/REPLENISHING WINDOW WASHER SOLUTION	255
[8] CHECKING AND SERVICING AIR-CONDITONER	256
[9] CHECKING/CLEANING/GREASING DOOR RAILS AND ROLLERS	257



<b>Inspection and maintenance items</b>	<b>Page</b>
[10] LEVELLING INSTRUMENT	258
<b>10.4 MAINTENANCE EVERY 50 HOURS</b>	258
[1] GREASING MACHINE UNITS	258
<b>10.5 MAINTENANCE EVERY 250 HOURS</b>	260
[1] CHECKING/REFILLING OIL LEVEL IN TRAVELLING MOTOR REDUCTION GEAR CASE	260
[2] OIL LEVEL CHECK AND REFILLING IN WINCH REDUCTION GEAR CASE	261
[3] CHECKING/ADJUSTING FAN BELT TENSION	262
[4] CHECKING/ADJUSTING AIR-COMPRESSOR BELT TENSION	263
<b>10.6 MAINTENANCE EVERY 500 HOURS</b>	264
[1] REPLACING OIL IN ENGINE OIL PAN AND REPLACING ENGINE OIL FILTER CARTRIDGE	264
[2] CHECKING/REFILLING SWING PINION GREASE AMOUNT	266
[3] GREASING SWING CIRCLE	266
[4] CHECKING/CLEANING RADIATOR FINS, OIL COOLER FINS, AFTER COOLER FINS AND AIR-CONDENSER FINS	267
[5] CLEANING AIR-CONDITIONER OUTDOOR/INDOOR AIR CONDITIONER FILTERS	268
[6] REPLACEMENT OF HYDRAULIC OIL TANK BREATHER ELEMENT	269
[7] OIL REPLACEMENT IN WINCH REDUCTION GEAR CASE (FOR THE FIRST TIME ONLY)	270
[8] REPLACING THE FUEL PRE-FILTER CARTRIDGE	271
[9] REPLACING THE MAIN FUEL FILTER CARTRIDGE	272
[10] REPLACING THE FUEL FEED PUMP FILTER	273
<b>10.7 MAINTENANCE EVERY 1000 HOURS</b>	274
[1] OIL REPLACEMENT IN TRAVELLING MOTOR REDUCTION GEAR CASE	274
[2] OIL REPLACEMENT IN WINCH REDUCTION GEAR CASE	275
[3] REPLACEMENT OF HYDRAULIC OIL RETURN FILTER CARTRIDGE	276
[4] REPLACEMENT OF HYDRAULIC OIL LINE FILTER ELEMENT	278
[5] CHECKING ALTERNATOR AND STARTER	279
[6] INSPECTION/ADJUSTING ENGINE VALVE CLEARANCE	279
[7] MEASURING COMPRESSION PRESSURE	279
<b>10.8 MAINTENANCE EVERY 1500 HOURS</b>	279
[1] CLEANING EGR COOLER	279
<b>10.9 MAINTENANCE EVERY 3000 HOURS</b>	279
[1] CHECKING/CLEANING EGR VALVE	279
<b>10.10 MAINTENANCE EVERY 4000 HOURS</b>	280
[1] INSPECTION OF WATER PUMP	280
[2] REPLACEMENT OF ACCUMULATOR	280
<b>10.11 MAINTENANCE EVERY 5000 HOURS</b>	281
[1] REPLACING OIL IN HYDRAULIC OIL TANK AND CLEANING STRAINERS	281



## 10. MAINTENANCE PROCEDURE

### 10.1 INITIAL 500 HOUR MAINTENANCE

The following maintenance should be performed after 500hours of operation for the 1st maintenance servicing only, of a new machine.

#### **[1] OIL REPLACEMENT IN WINCH REDUCTION GEAR CASE**

See "10.7 MAINTENANCE EVERY 1000 HOURS " for maintenance places and procedure.

### 10.2 PRE-OPERATION INSPECTION

Inspections described in this section should be conducted before the first engine start-up of the day.

See "9. LIST OF ITEMS FOR INSPECTION AND MAINTENANCE" for the items of pre-operation inspection.

See "OPERATION 3.1 PRE-OPERATION INSPECTION" for maintenance places and procedure of pre-operation inspection.

## 10.3 IRREGULAR MAINTENANCE

### [1] REPLACEMENT OF WINCH WIRE ROPE

#### ⚠ WARNING

Always put on thick leather work gloves when replacing the wire rope.

#### CAUTION

- The diameter of the wire rope is measured at points where the wire repeatedly runs through the sheave. A mean value needs to be determined through 3 way measurement. (A measurement should be performed not only at 1 point but also at several points with a space between the points.)
- Do not use old wire rope regardless of the frequency of use.

### [CRITERIA FOR WIRE ROPE REPLACEMENT]

A wire rope undergoes wear and tear over time.

Prompt replacement is required if any of the following appears in the wire rope.

1. With respect to the total number of elemental wires in the outermost strand (excluding filler wires), when the number of broken wires is equal to or greater than the following ratio
  - (1) 10% or more of a single twist of rope. Nevertheless, when breakage occurs in a single strand only, the ratio should be 5% or more.
  - (2) 20% or more of 5 twists of rope.
2. A rope of which reduction in diameter due to abrasion exceeds 7% of the nominal diameter.

#### NOTES

Replace the 10mm diameter wire rope when it is reduced to 9.4mm.

3. When either of the following is observed due to corrosion:
  - (1) Pitching occurred on the wire surface, that has turned pockmarked.
  - (2) Wires that have lost tension due to internal corrosion.
4. As a result of form collapsing, the following are observed:
  - (1) A strand that is kinked.
  - (2) When the width of an undulation exceeds  $\frac{4}{3}d$  within a section that is 25 times of nominal diameter  $d$ .
  - (3) When a wire rope is flattened by local crushing and the minimum diameter is  $\frac{2}{3}$  of the maximum diameter or less
  - (4) A rope of which core wires or rope core is exposed.
  - (5) A rope extremely bent
  - (6) A rope appearing like a cage
  - (7) A strand that has been intruded.

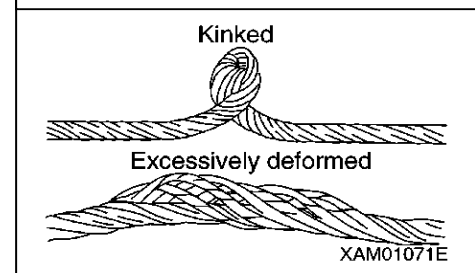
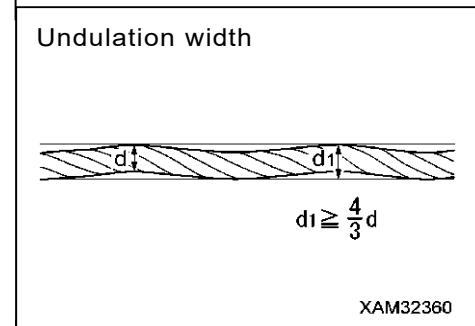
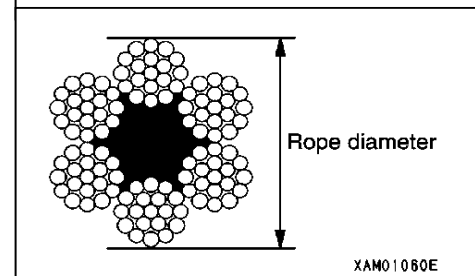
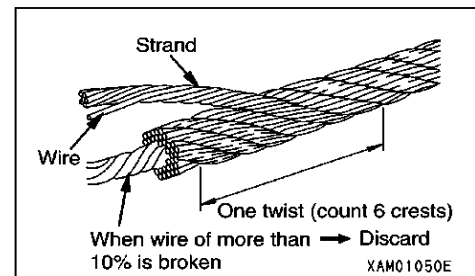



- (8) One or more strand is loosened.
  - (9) Wires that are noticeably sticking out.
5. An end socket that is found faulty.

**[REMOVAL OF WINCH WIRE ROPE]**

**⚠ WARNING**

Always put on thick leather work gloves when handling the wire rope.

**CAUTION**

After lowering the hook block on the ground, an attempt of further unwinding give rise to the irregular winding of wire rope on the winch drum. When the hook block has been lowered on the ground, never try to unwind the rope.

Use the following procedure to remove the wire rope.

1. Stop the Machine on solid ground, fully retract the boom and set the boom angle to approximately 20 degrees.
2. Unwind the winch from the state under item 1 above to unwind the hook block until it is almost touching the ground.
3. Bring down the hook block to the ground by performing the boom derricking down operation.

4. Remove the wire socket fixing bolt (1), pull off the wire socket pin (2) and remove the wire socket (3).
5. Remove the wire clip (4).

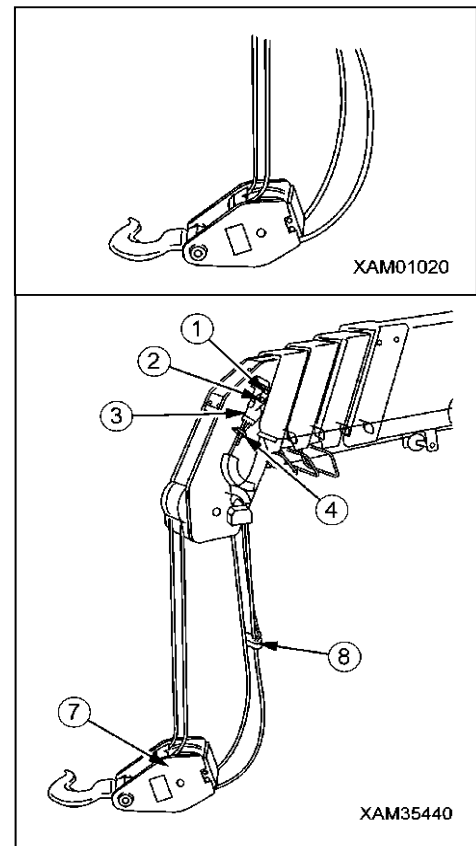

6. Pull the wire rope (5) out of the wire socket (3), following the procedure provided below.

(1) Bring a 6 to 10mm round bar (A) into contact with the rope wedge (6).

(2) Remove the rope wedge (6) by lightly tapping the round bar (A) with a hammer in the direction indicated by the arrow (a).

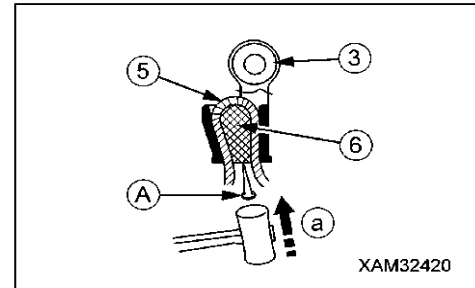

7. Pull out the wire rope (5) from the weight (8) of over winding alarm device and from hook block (7).

8. Operate the right machine operation lever to "DOWN" (push it forward) to wind up the wire rope (5) from the winch drum (9).

9. After winding up the wire rope (5) on winch drum (9), release the end of wire rope (5) that is fixed to the winch drum (9) as described below:

(1) Bring a 6 to 10mm round bar (A) into contact with the rope wedge (10).

(2) Remove the rope wedge (10) by lightly tapping the round bar (A) with a hammer in the direction indicated by the arrow (b).

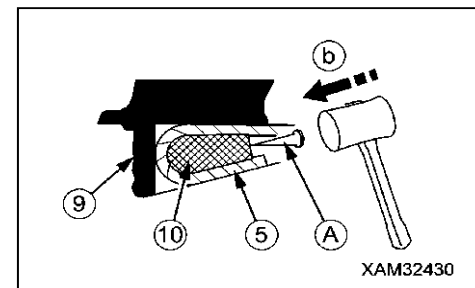

10. Wind up the remaining wire rope (5) completely.

Removal of the winch wire rope is completed.

**[INSTALLATION OF WINCH WIRE ROPE]**

**⚠ WARNING**

- Always put on thick leather work gloves when replacing the wire rope.
- Be sure to attach the rope wedge properly to secure the wire rope. Serious accidents may occur if the wire rope is detached during crane operations.

**CAUTION**

- Avoid irregular winding of the wire rope on the winch drum.
- Every time immediately after attaching a new rope, hoist a weight (approximately 0.98 kN [100 kg]) with the boom extended and raised fully, and repeat raising and lowering the hook several times to allow the new rope to be conformed.
- The wire rope is coiled. Exercise caution not to form a kink in the rope when winding it up. Be sure to unravel by rotating the rope to pull it out of the winch drum.

Use the following procedure to attach the wire rope.

1. Hold the wire rope and pass the wire rope (5) through the weight of over-winding prevention unit, load sheave (11) at the end of load sheave (11), wire guide (12) of boom Nos. 2, 3 and 4, roller sheave (13), sheave (14) inside the boom derricking cylinder mounting bracket, and slide sheave (15).

2. Draw the wire rope (5) through the rope attachment hole of the winch drum (9). Secure the wire rope (5) to the winch drum (9), following the procedure provided below.

(1) Draw the slackened wire rope (5) through the winch drum (9).

(2) The rope wedge (10) should be in position (a). Pass the wire rope (5) around the rope wedge and yank (pull) at the rope in the direction indicated by the arrow.

In this step, adjust the length of the wire rope (5) to keep the end of the wire rope from protruding from the narrow hole in the winch drum (9).

3. Operate the right machine operation lever to "RAISE" (pull toward the operator) to wind up slowly the wire rope (5) to the winch drum (9).

At this point, leave the wire rope for about 10 meters unwounded ahead of the boom edge.

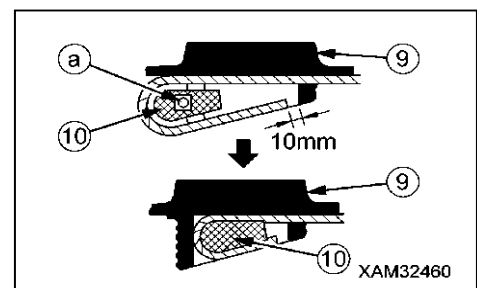
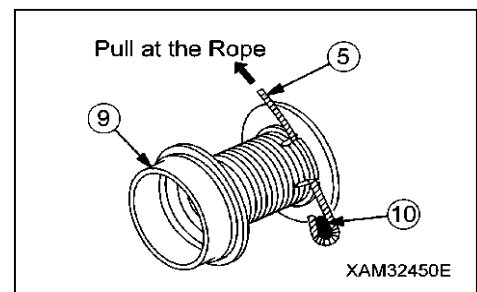
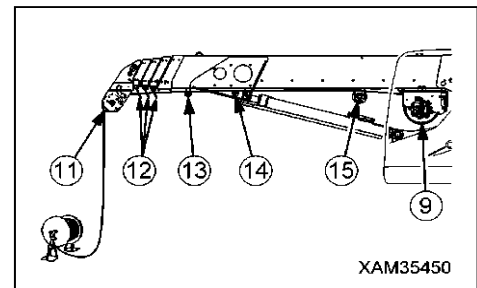

**CAUTION**

To prevent irregular winding, apply a tension force of approximately 1.47kN (150kg) particularly to the layers 1, 2 and 3 during the winding.

4. Depending on the number of falls of wire rope, pass the wire rope through the load sheave and hook block sheave as illustrated in the following sketches:

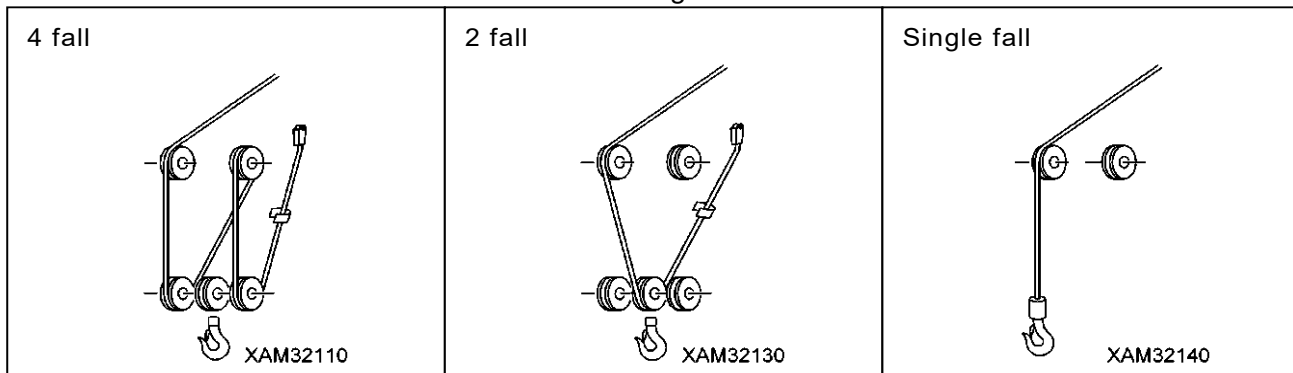

5. Pass the wire rope (5) through the weight of over-winding prevention unit.

6. Secure the end of the wire rope (5) to the wire socket (3), following the procedure provided below.

(1) Draw the wire rope (5) through the wire socket (3) as shown in the diagram at the right.

(2) The rope wedge (6) should be in position (a). Pass the wire rope (5) around the rope wedge and yank at the rope in the direction indicated by the arrow.

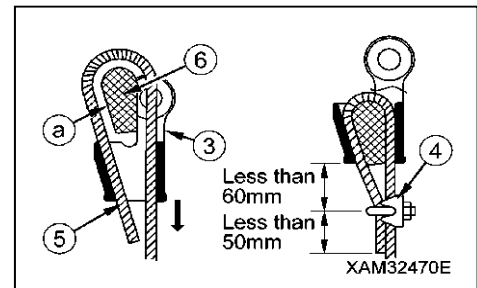

7. Fix a rope clip (4) to the wire rope (5) according to the dimensions specified in the sketch at right.

8. Apply a wire socket (3) to the boom by using a wire socket pin (2), and tighten the wire socket pin fixing bolt (1).

9. Operate the right machine operation lever to "RAISE" (pull inward), or operate the left machine operation lever to "EXTEND" (push forward) to raise the hook block.

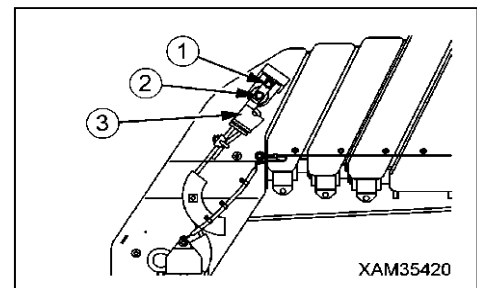

### NOTES

Winch operation is allowed only after the hook block is raised.

10. Allow the boom to be fully extended and fully raised. While applying tension to wire rope (5), operate the right machine operation lever to winding side (pull toward the operator) to wind up the wire rope (5) to the winch drum (9).

### NOTES

In this step, watch from the operator's seat the irregular winding check mirror (1) provided under the winch drum to see if any irregular winding takes place.

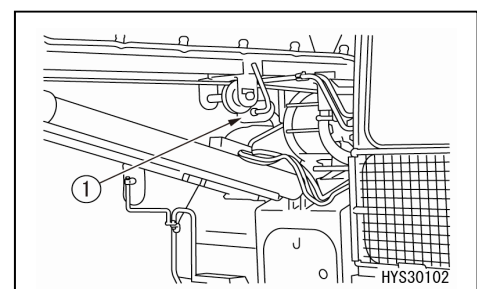

**[2] CHECKING/ADJUSTING MAIN BOOM TELESCOPING WIRE ROPE**

**⚠ WARNING**

- Always put on thick leather work gloves when replacing the wire rope.
- Do not fail to follow the procedure to adjust securely the for boom telescoping wire rope. Omitting procedural steps or leaving faulty adjustment increases the risk of fall of the boom or load.

**[CHECKING THE BOOM TELESCOPING WIRE ROPE]**

When the boom extending wire rope shows a following condition, adjust it accordingly.

1. After allowing the boom to be horizontal, repeat the telescoping operation for several times, and then fully retract it.
2. Measure the gap between booms No. 4 (2) and 5 (gap (a) in the figure at the right).

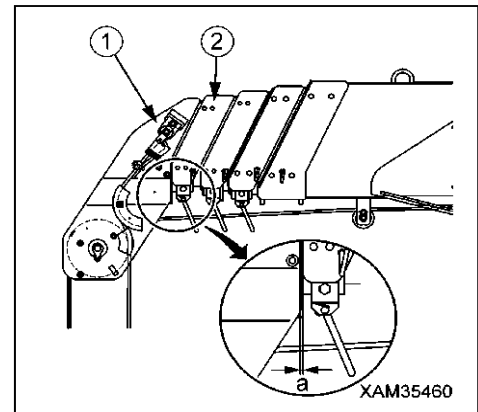

**NOTES**

- When the gap (a) is 2mm or less, the wire rope does not need to be adjusted.
- When the gap (a) is 2 to 4mm, conduct the adjustment by referring to the item "Adjusting the main boom extending/contracting wire ropes".
- When the gap (a) exceeds 4mm, adjustment of the boom telescoping cylinder is needed. Thus, consult with us or our sales agency.

**[ADJUSTING THE BOOM TELESCOPING WIRE ROPE]**

If the gap (a) is found to be 2 to 4 mm as a result of the wire rope inspection, adjust the wire rope by using the following procedure:

1. Remove the mounting bolts (4) (4 bolts) and then remove the inspection cover (3).
2. Remove the (two) mounting bolts (6), (two) washers, and the support (5).
3. Loosen all the wire rope adjusting bolts (7) on both of left and right side for one turn.
4. Remove the (two) mounting bolts (9), (two) washers, and the support (8).
5. Tighten the wire rope boom telescoping wire rope adjustment bolt (10) to set the gap (a) to 2mm or less.
6. After adjustment, mount each of the supports (5) and (8), mounting bolts (6) and (9), and washers to the respectively original positions and tighten the mounting bolts of left and right evenly.
7. Attach the cover (3) at the end of boom and tighten the mounting bolts (4).

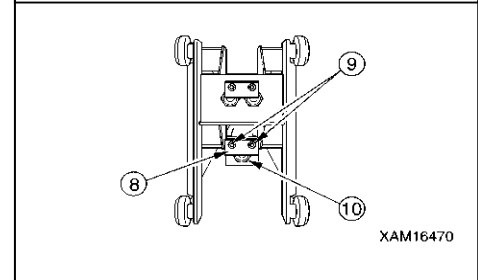
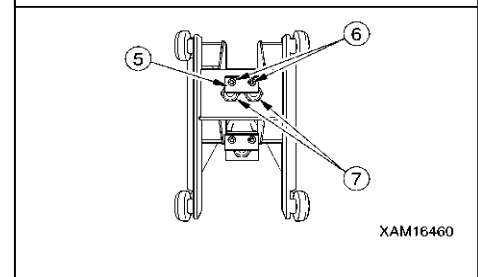
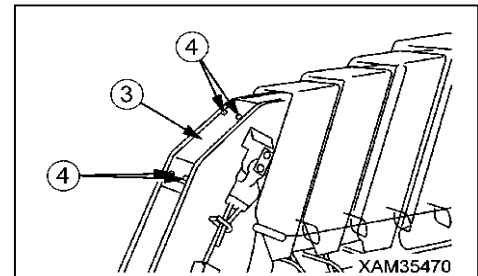

### [3] CHECKING/CLEANING/REPLACING AIR CLEANER

#### ⚠ WARNING

- Do not clean and replace the air cleaner when the engine is in rotation. Such action may cause damage to the engine.
- When using the compressed air, watch out for dust scattering, which may cause bodily accidents. Wear goggles, dust mask and other protective equipment.

#### [Inspection]

1. Open the right cover.
2. If the transparent window of dust indicator (1) shows a red piston, clean the air cleaner element.

#### CAUTION

Until the transparent window of dust indicator (1) shows a red piston, do not clean the air cleaner element.

If the element is frequently cleaned before the red piston appears, the air cleaner fails to show its true performance and its efficiency is spoiled.

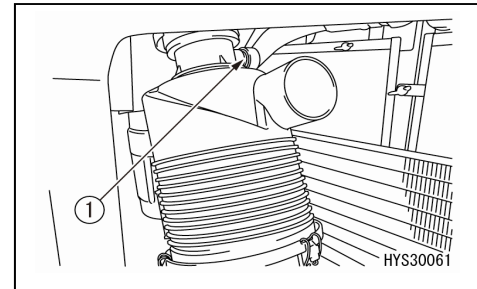

#### [CLEANING/REPLACING THE ELEMENT]

1. Open the right cover.
2. Remove the clamps (2) (3 locations) of air cleaner and take off the cover (3).
3. Take out the element (4).

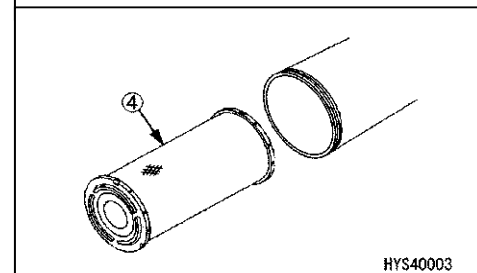
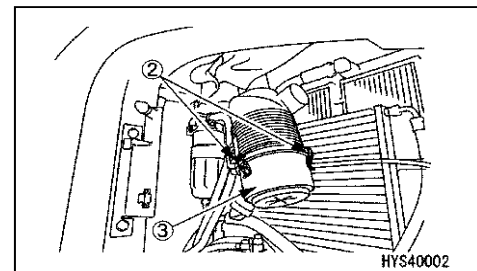

4. Clean the inside of air cleaner body and the cover (3).

#### CAUTION

When cleaning the cover (3), do not remove the vacuator valve (5).

5. Check the vacuator valve (5) for any degradation of clogging.

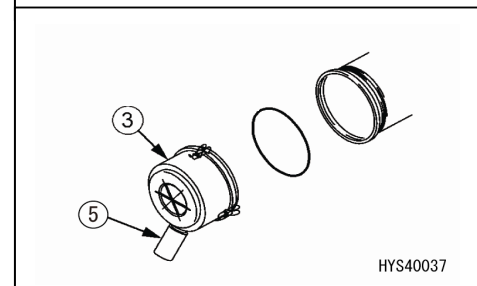



6. Shine a light bulb into the element after cleaning for inspection. If inspection finds a pore or thinning part, replace the element.

**CAUTION**

- Do not tap and bump the element while cleaning it.
- Avoid using the element if the groove, gasket, or sealing is damaged.
- Pack the unused elements and store them in a dry place.

7. Set the cleaned element inside the body, attach cover (3) and fix it with clips (2).

**CAUTION**

When attaching the cover (3), check the O-ring (7) and if it is scratched, replace it.

**CAUTION**

Writing down the date of cleaning/replacing the element on the cover surface. This is a convenient reference to the servicing history.

- Press the button on the dust indicator to return the red piston.

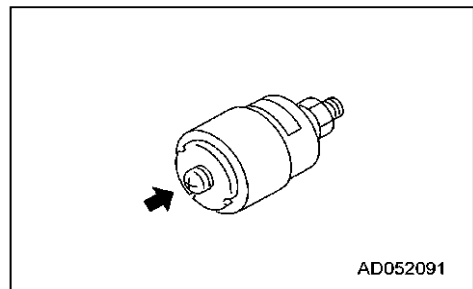
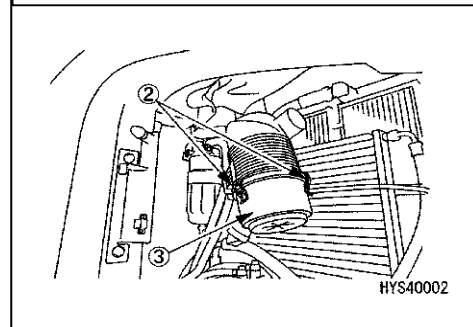
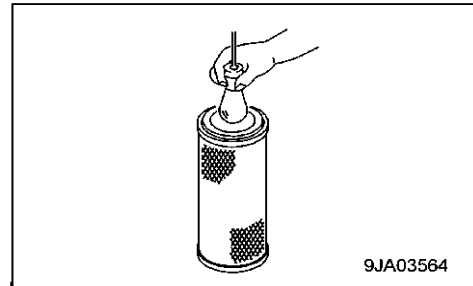



**[4] CLEANING ENGINE COOLING SYSTEM**

**⚠ WARNING**

- Coolant temperature remains high immediately after stopping the engine and the pressure is accumulated in the radiator. Removing the cap in this stage for discharging water may cause burns. Allow it to cool down, and then slowly turn the cap to relieve the pressure.
- Start the engine for cleaning. Before standing up from the operator's seat or leaving it, set the lock lever to LOCK.
- While cleaning the inside of cooling system, the engine is kept running, and thus it is dangerous to stay in the rear of the engine. While running the engine never enter the rear section of the machine.

Cooling system cleaning and coolant replacement should conform to the cycles specified in the following table.

Coolant type	Cooling system cleaning and antifreeze replacement
Coolant LLC	Every 2 years (in fall) or every 4000 hours, whichever falls first

Stop the machine on a level place and perform cooling system cleaning and antifreeze replacement.

While the mixing proportion of coolant varies with temperature, a volumetric proportion of 30% as a minimum is required.

Even in areas where antifreezing is not needed, use the coolant at a minimum proportion of 30% to prevent corrosion of cooling system.

The mixing proportion between water and the coolant is to be determined with respect to past minimum temperatures, in accordance with "Table of Mixing Proportion of water and undiluted coolant" shown below. For actual mixing, set temperature approx. 10 degrees lower than minimum temperature.

Freezing temperature of 100% coolant as supplied is -15°C. Be cautious of not storing the undiluted coolant below -15°C.

**[Table of Mixing Proportion of water and undiluted coolant]**

Min. temperature (°C)	-10 or more	-15	-20	-25	-30
Mixed quantity (L)					
Coolant quantity	3.6	4.2	4.8	5.4	6.0
Water amount	8.4	7.8	7.2	6.6	6.0
Volumetric proportion (%)	30	35	40	45	50

**⚠ WARNING**

- Since the undiluted coolant is flammable, be cautious of fire.
- The coolant is toxic. When opening the drain valve, be cautious not to be exposed to splashes of the coolant solution. If it gets in the eyes, immediately wash your face with clean water and see a doctor for treatment.
- The disposal of cooling water added with the coolant discharged when replacing the cooling water and repairing the radiator should be consigned to a specialized subcontractor, or contact us or our sales service agency. Since the coolant is toxic, never drain it into drainage or sprinkling it on the ground.



## CAUTION

- Always use tap water for coolant. Contact us or our sales service agent if river water, well water, or water through the small water-supply system is necessarily substituted for tap water.
- The mixing proportion of coolant is recommended to be controlled by using the coolant concentration meter.

- Provide a container with a capacity of 15 liters for cooling water containing the coolant.

### [DRAINING]

1. Place the machine on a level surface and stop the engine.
2. Take off the under cover.
3. Put a container for holding cooling water under the drain hose (1).
4. Ensure that the surface temperature of the radiator cap (2) is as low as can be touched with a bare hand, and slowly turn it until it butts with the the stopper to relieve the internal pressure.
5. Then remove the radiator cap (2).
6. Open the drain valve (3) underneath the radiator to drain the water.
7. Remove the drain plug (4) of the cylinder block to drain the water.
8. After draining, close the drain valve (3) and refit the drain plug (4).

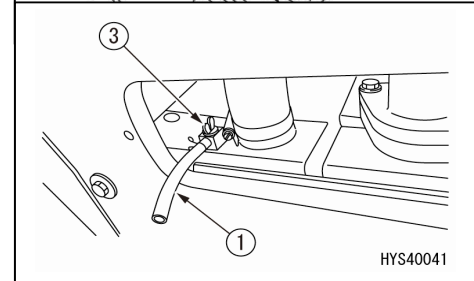
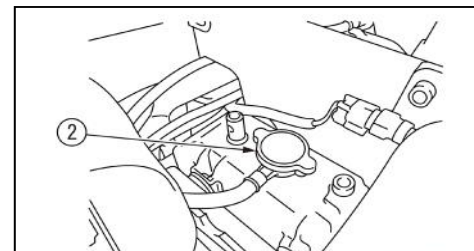

HYS40041

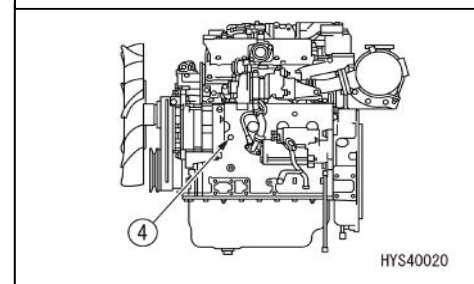

HYS40020

### [CLEANING]

1. Pour tap water through the water inlet.
2. Check and clean the radiator cap. If it is faulty, replace it.
3. Securely attach the radiator cap.
4. Pour the specified quantity of water into the reserve tank, and close the cap.
5. Start the engine and run it at an idling revolution speed.
6. While the engine is kept idling, raise the water temperature to 90°C or more and continue the operation for 20 minutes.
7. Stop the engine, open drain valve (3) again, and remove drain plug (4) to drain the water.
8. Close the drain valve (3) and refit the drain plug (4) using a sealing tape.
9. Attach the the under cover.

**[FEEDING WATER]**

1. Pour tap water and the coolant through the water inlet until the liquid level reaches the lip of the inlet.  
For the mixing proportion of water and the Super Coolant, refer to the "Table of mixing proportion of water and undiluted coolant".
2. Loosen the air vent plug (5) of EGR cooler to vent the air entrapped in the cooling water.

**CAUTION**

- **When the air vent plug is loosened replace the gasket without fail.**

3. If cooling water is overflowing from the air vent plug, tighten the air vent plug.
- ★Tightening torque for the air vent plug: 27.5 N·m [2.8 kgf·m]
4. Securely attach the radiator cap (2).
5. Replenish cooling water to the specified quantity of sub tank (6) and close the cap of sub tank (6).
6. Start the engine and after running at an idling speed for about 3 minutes, stop the engine.
7. After the coolant is found to have been cooled, slowly remove the radiator cap (2), and if the level has been lowered, fill the cooling water to the lip of the radiator water inlet.
8. Securely mount the radiator cap (2), start the engine, and warm up the engine at an idling speed. When the radiator is equipped with a heater, the air entrapped in the heater circuit must be vented. Maximize the set temperature and blower revolution speed. Then, perform the warm-up run until the water temperature meter indicator is stabilized at a revolution speed around 1500 rpm or more (cooling water temperature: approx. 75 to 90°C), and then stop the engine.
9. When the engine is cooled, the pressure inside the radiator becomes negative, and consequently the cooling water is poured automatically from sub tank (6) to the radiator. After the cooling water is found to have been cooled, slowly remove the radiator cap, and if the level has been lowered, fill the cooling water to the lip of the radiator water inlet. If the water level is extremely low, check for any leakage of cooling water.
10. Securely attach the radiator cap (2).
11. Replenish cooling water to the specified quantity of sub tank (6) and close the cap of sub tank (6).

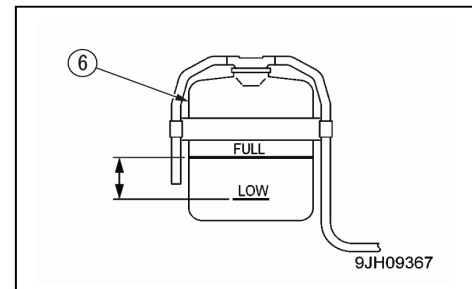
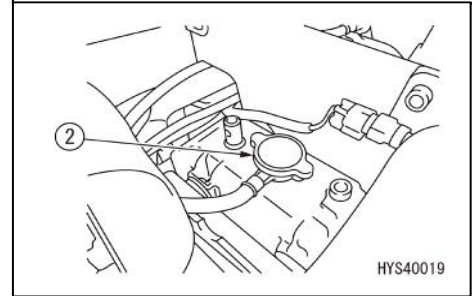
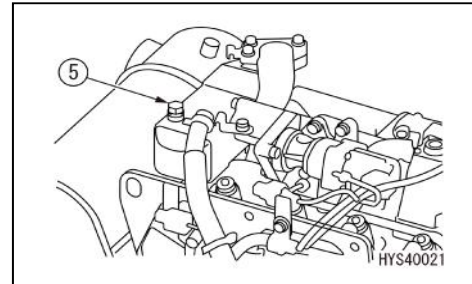

### [5] CHECKING AND RE-TIGHTENING RUBBER TRACK BOLTS

Using the Machine while its rubber track bolts (1) are left loosened will cause the bolts to break, fasten each of the loosened bolts.

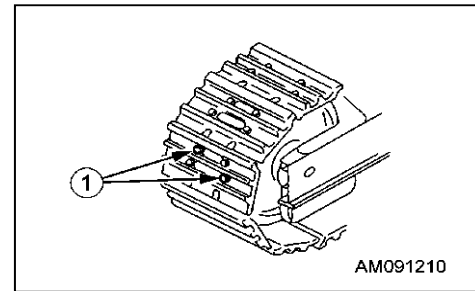

### [METHOD FOR RETIGHTENING BOLTS]

1. After tightening the bolts with a tightening torque of  $196 \pm 19.6 \text{ N}\cdot\text{m}$  [ $20 \pm 2 \text{ kgf}\cdot\text{m}$ ] first, ensure that the nuts and shoes are a tight fit to the link mating surface. After checking, re-tighten them at a tightening angle of  $90 \pm 10$  degrees.

### [TIGHTENING SEQUENCE]

Tighten the bolts in the order indicated in the diagram on the right.

After tightening, check to ensure that the nuts and shoes are a tight fit to the link mating surface.

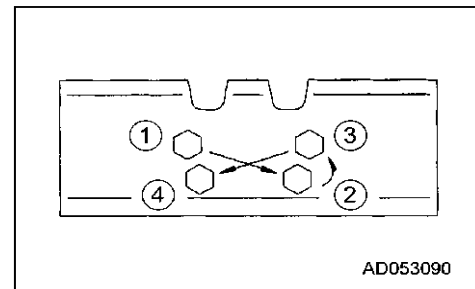

### [6] CHECKING/ADJUSTING RUBBER TRACK TENSION

The pins and bushings around the footage of the Machine shows varied states of abrasion depending on the working conditions and soil quality. Check the tension of rubber track at any time to maintain the standard tension.

Conduct the inspection and adjustment on flat and solid ground.

### [INSPECTION]

1. Keep the engine revolution in an idling state to allow the Machine to go forward for a distance equal to the length of rubber track in contact with the ground, and slowly stop travelling.
2. Place a square bar (3) that can bridge between idler (1) and upper rolling wheel (2) on the rubber track.
3. Measure the maximum sagging dimension between the upper plane of rubber track and the bottom surface of the square bar.

Reference value of sagging dimension (a): 10 to 30 mm is a normal range.

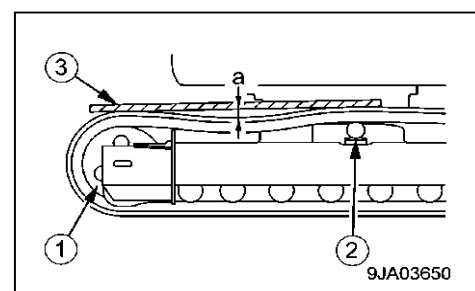

**[ADJUSTMENT]**

**⚠ WARNING**

- Do not loosen plug (1) for more than one turn. Loosening for more than one turn gives rise to the risk of plug (1) flying out because of the grease inside at a high pressure. In this stage, do not loosen any parts except the plug (1). Also, do not position your face in the direction where plug (1) is mounted.
- If the rubber track is not loosened by the procedure described here, request us or our sales agency for repair.

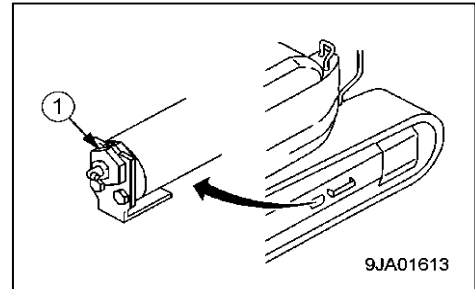

If the result of test indicates that the tension differs from the standard value, adjust it in the following manner:

**[STRENGTHENING THE TENSION]**

- Have a grease pump available.
- 1. By using the grease gun, inject the grease through the grease plug (2) opening.
- 2. To ensure that a proper tension is applied, keep the engine at an idling speed to travel forward for a distance equal to the length of rubber track in contact with the ground, and slowly stop travelling.
- 3. Check the tension of rubber track again.

If the tension is not appropriate, make another adjustment.

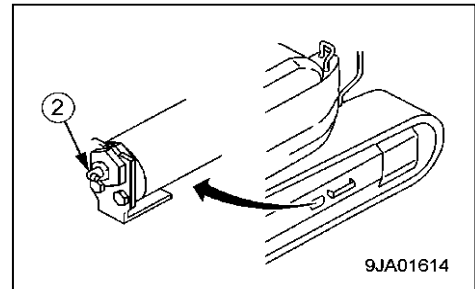

**CAUTION**

Until dimension (S) reaches "0mm", grease can be injected. However, if the tension is not enough, abrasion of pins and bushings is increasing. As reversing or replacement of pins and bushings is required, contact us or our sales agency for repair.

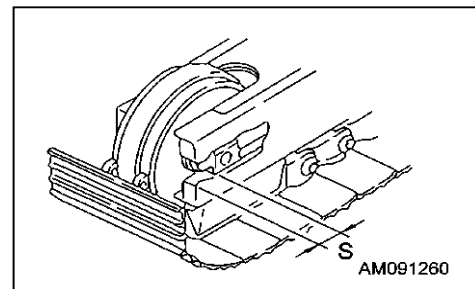

**[LOOSENING THE TENSION]**

**! WARNING**

Discharging grease without using the following procedure is extremely dangerous. If the rubber track is not loosened, request us or our sales service agency for repair.

1. Slowly loosen the plug (1) to discharge the grease.  
When loosening the plug (1), loosen it for only one turn at the most.

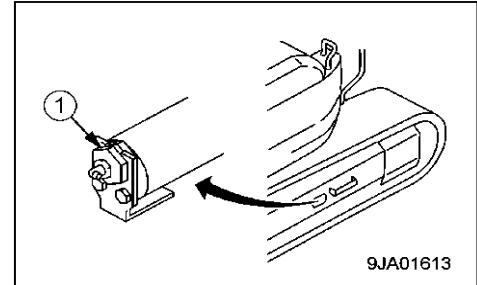

**NOTES**

If the grease cannot be smoothly discharged, slightly move the Machine back and forth.

- 2, Screw in plug (1).
3. To ensure that a proper tension is applied, keep the engine at an idling speed to travel forward for a distance equal to the length of rubber track in contact with the ground, and slowly stop travelling.
4. Check the tension of rubber track again.  
If the tension is not appropriate, make another adjustment.

**[7] CHECKING/REPLENISHING WINDOW WASHER SOLUTION**

If air is entrapped in the window washer solution, check the level of solution in the window washer tank (1), and if it is not enough, replenish with window washer solution for automobiles.

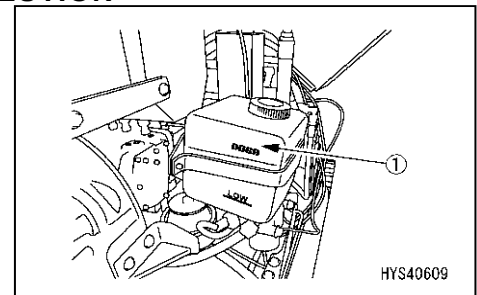

**NOTES**

When replenishing the window washer solution, pay attention to keep it free from dust.

**[PROPORTION OF UNDILUTED WINDOW WASHER SOLUTION AND WATER]**

Since the adequate proportion varies with temperature, add the window washer solution mixed with water at the following proportions:

Area and Season of Using the Solution	Mixing Proportion	Freezing Temperature
Normal	1/3 of undiluted liquid with 2/3 of water	-10°C
Winter in cold region	1/2 of undiluted liquid with 1/2 of water	-20°C
Winter in extremely cold region	Undiluted	-30°C

The user can select from two types provided for different temperatures of -10°C (for general services) and for -30°C (for extremely cold region) by also taking into account of the area and season of service.



**[8] CHECKING AND SERVICING AIR-CONDITONER  
[INSPECTING THE AIR-CONDITIONING UNITS]**

Users (possessors) of the Machine are obligated to conduct periodic inspections by the Fluorocarbon Refrigerants Emission Regulating Act.

Inspect once every three months. Even when the air-conditioner is not used during off season, the inspection is required.

**Check Item**

- Abnormal vibration and abnormal operation noise of the compressor
- Oil oozing out on and around the compressor
- Scratches, corrosion, rust and other blemishes on the compressor
- Frosting of air-conditioner heat-exchanger in the cabin.

**[CHECKING THE QUANTITY OF REFRIGERANT (GAS)]**

**⚠ WARNING**

- If the refrigerant of air-conditioner gets into the eyes, loss of sight may occur and if it comes into contact with skin, it gives rise to a frostbite. Never touch the refrigerant. Do not loosen any parts within the refrigerant circuit.
- In an area where refrigerant is leaking, never bring fire into the area.

**⚠ CAUTION**

If any shortage of refrigerant (gas) is found, be sure to identify the spot of its leakage and repair it. Also, when replenishing refrigerant, the replenishing work must be consigned to a Class 1 fluorocarbon refrigerants filling and recovering contractor registered by the competent authorities in accordance with the Fluorocarbon Refrigerants Emission Regulating Act, and have a replenishment certificate issued by the contractor and file it at the user's office.

Shortage of the refrigerant (gas) affects the cooling performance.

While the engine is running at full revolution speed for operating the air-conditioner at a high speed, check the state of refrigerant gas (R134a) flowing in the refrigerant circuit by viewing it through sight glass (1) (inspection window).

- (A) No air bubble is included in the flow: Normal
- (B) Air bubbles are included in the flow (air bubbles pass continuously): The refrigerant is insufficient.
- (C) Colorless and transparent: No refrigerant

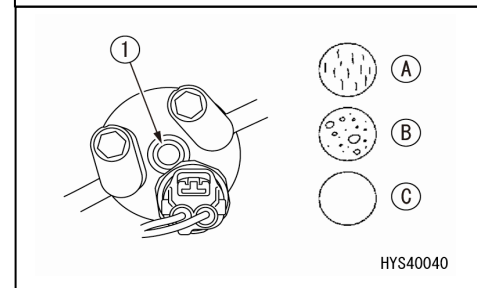
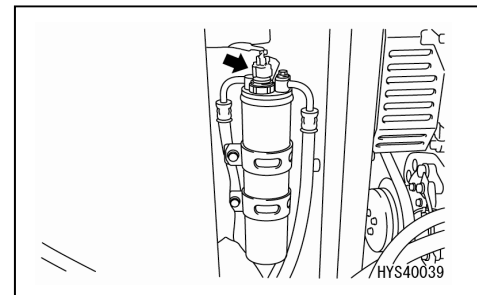

**NOTES**

When air bubbles are generated, the refrigerant is insufficient and thus needs repair. Refill the refrigerant. Consign the refilling to a Class 1 fluorocarbon refrigerants filling and recovering contractor registered by the competent authorities.

**[KEEPING THE MAINTENANCE RECORD]**

Keep the records of administrator's name, location of the machine, initial amount of Freon filled, and dates of inspection, repair, refrigerant recovery, and refrigerant filling until the machine is disposed of.



**[ACT ON RATIONAL USE AND PROPER MANAGEMENT OF FLUOROCARBONS]**

The Act on Rational Use and Proper Management of Fluorocarbons (Fluorocarbon Refrigerants Emission Regulating Act) stipulates that the operating entity (possessor) of air-conditioners shall endeavor to suppress the emission of fluorocarbons that cause the global warming and ozone layer destruction. (Liability of the operator of specified product and specifically designated products: Article 5)

Negligence of such pertinent management practice as the use of fluorocarbons (CFC, HCFC and HFC) recommended by a manufacturer, inspection and preservation of records of maintenance services are subject of punishment under said Act.

**[INSPECTION DURING SEASON OFF]**

Even during season off, the air-compressor need to be operated for 3 to 5 minutes once a month in order to prevent every moving part from the loss of lubricating oil.

**[LIST OF MAINTENANCE ITEMS OF AIR-CONDITIONER]**

Inspection and maintenance item	Details of inspection and maintenance servicing	Recommended servicing interval
Refrigerant (gas)	Replenished quantity	Every 3 months
Condenser of air-conditioner	Clogging of fins	"
Compressor	Operating condition	"
V-belt	Extent of damage and state of tension	"
Blower motor and fan	Operating condition (any abnormal noise)	Every 3 months
Control mechanism	Operating condition (does it functions normally)	"
Each pipe joint	Mounted state, loosening of tightened/connected parts, gas leakage and damage	"

**[9] CHECKING/CLEANING/GREASING DOOR RAILS AND ROLLERS**

**[INSPECTION]**

When the door is opened or closed, if it fails to move smoothly because it is clogged with dirt or the like, clean the slide door rail (1) and rollers (2), and grease them.

**[METHOD FOR CLEANING THE DOOR RAIL]**

1. Open and close the door and remove dirt on the rail (1).
2. Wipe off dirt on rail (1) by using cloth and rags.

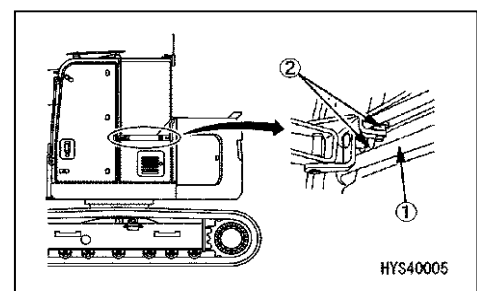

**[METHOD FOR GREASING THE DOOR RAIL AND ROLLERS]**

**CAUTION**

**Do not use excessively viscous lubricants.**  
**Manufacturer's recommendation: "Pando 18C" of ThreeBond Co., Ltd.**

1. Spray an adequate amount of spray type lubricating oil to the rail (1) and rollers (2).
2. After applying the lubricant, slide the door to ensure that it can be opened and closed smoothly. Contact us or our sales service agency if it cannot be moved smoothly.



**[10] LEVELLING INSTRUMENT**

**⚠ WARNING**

If crane operation is performed with the machine tilted, tipping may occur. Search for a place, while looking at the levelling instrument, where the machine body is in a level state before starting crane operation. If work is unavoidably performed on a slope, place planking or lay earth on the ground to make the ground level.

This displays the inclination status of the machine. The inclination and direction of the machine can be determined from the position of the air bubbles. Use this to check whether the machine body stopped on the worksite is in a level condition.

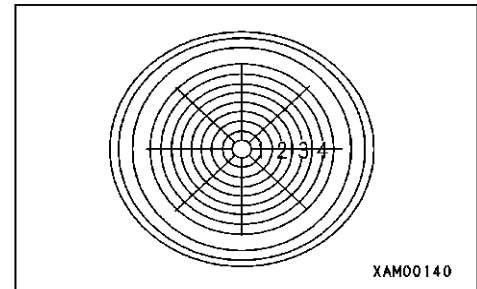

**10.4 MAINTENANCE EVERY 50 HOURS**

**[1] GREASING MACHINE UNITS**

**CAUTION**

- Grease type varies with greasing points. Failure to grease properly may cause the machine to shorten its useful life. Follow the guidance indicated in the column "Type of grease" in the following table.
- Greasing a new machine is required once every 10 hours until the machine reaches the first 100 hours of operation.

- Use proper grease specified below according to the greasing points.

No.	Greasing point		Grease type
1	Greasing of the boom mounting pin	1 places	Lithium grease
2	Greasing of the derrick cylinder bottom mounting pin	1 places	
3	Greasing of the derrick cylinder rod side mounting pin	1 places	
4	Greasing the guide sheave	1 places	
5	Greasing the wire retaining roller pin	2 places	
6	Greasing the hook block	1 places	
7	Applying grease on the inside of derricking cylinder rod guard	2 places	
8	Greasing of the boom slide plate	4 places	Grease for booms
9	Greasing of both sides and underside of the boom	Each boom	
10	Greasing of the winch wire rope	1 fall	Rope oil

1. With the use of the grease gun, inject grease through corresponding grease plugs indicated by the arrow (see the following page) of the above table "No.1 to 6".
2. Wipe off old grease squeezed out after greasing.
3. Set the left work equipment operation lever in the "Extend" position (push it forward) to extend the boom for greasing both sides and underside of the boom and wire rope.
4. Apply red rope grease to prevent wire rope abrasion and rust formation. With the rope surface cleaned, grease the rope with a brush.



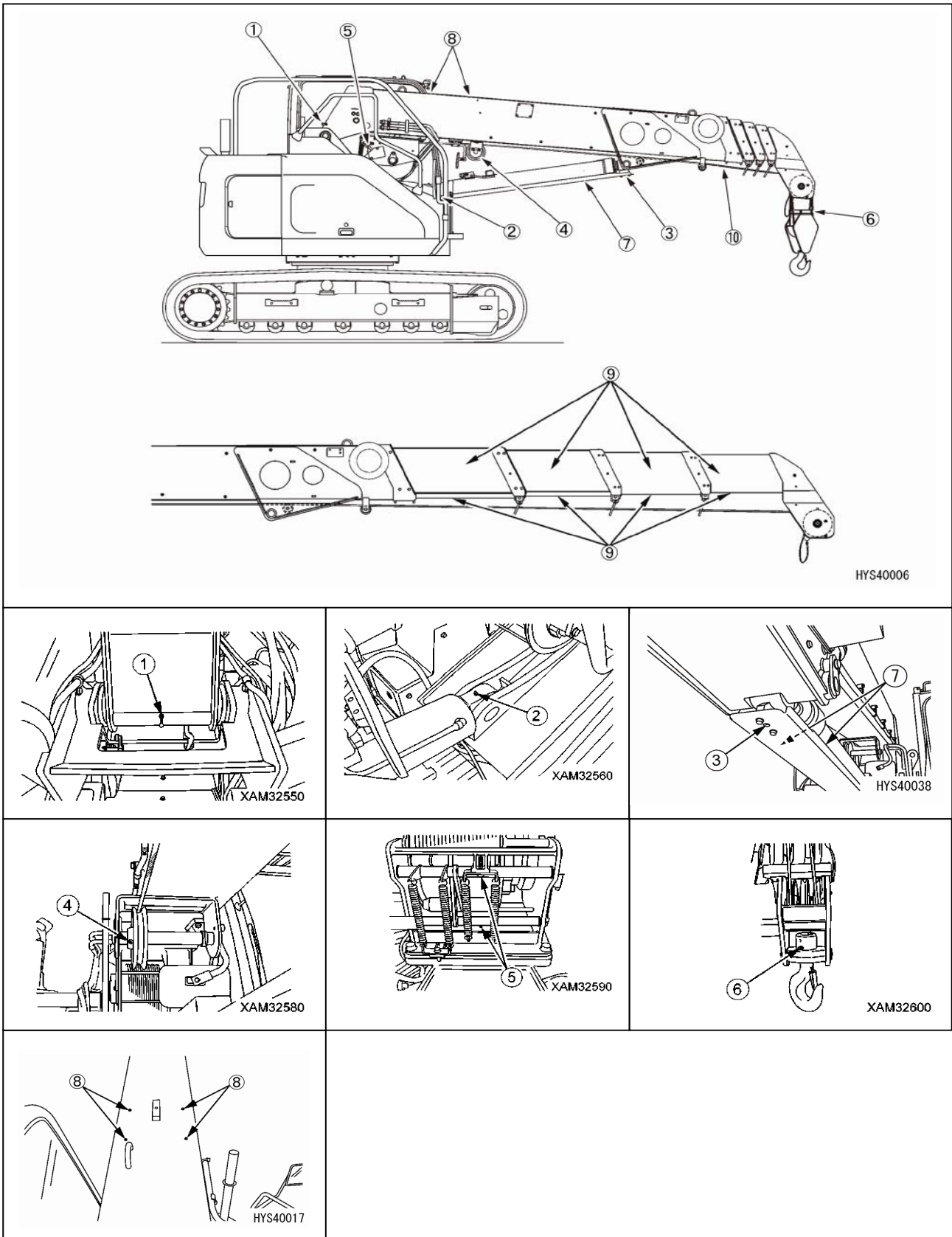

## 10.5 MAINTENANCE EVERY 250 HOURS

Perform this maintenance in tandem with maintenance every 50 hours.

### [1] CHECKING/REFILLING OIL IN TRAVELLING MOTOR REDUCTION GEAR CASE

#### **⚠ WARNING**

- Various parts are at elevated temperatures immediately after stopping the engine operation. Do not check oil level immediately. Wait until the oil is cooled.
- If there remains a residual internal pressure of the case, the oil and the plug may jump out. Accordingly, slowly loosen the plug to relieve the pressure.

#### **CAUTION**

- See “MAINTENANCE 7.1 USE OF FUEL AND LUBRICATING OIL ACCORDING TO TEMPERATURES” for the oil to be used.
- Use seal tape, etc. to the thread of the oil level check plug to stop oil leaks and securely tighten the plug after checking/refilling the oil.

- Prepare a container to receive spent oil.
  - Have a hexagonal wrench available.
1. Move the Machine back and forth to align the oil feeding inlet plug (F) and drain plug (P) in the vertical position to the ground.
  2. By using a hexagonal wrench, remove the oil level check plug (G) and ensure that the level is within the normal range from the lower end of the plug opening to 10mm below.
  3. If the oil level is low, remove the oil inlet plug (F) and feed oil through the plug hole.

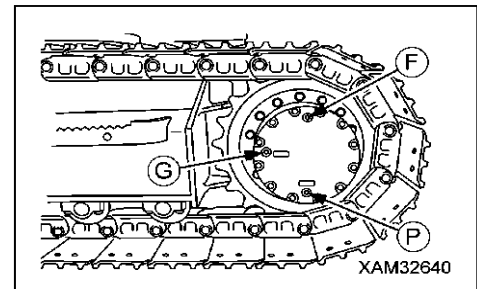

#### **NOTES**

- Fill the oil until it overflows from the oil level check plug hole (G).
- Wipe clean any spilt oil.

4. After checking and refilling oil, mount the oil inlet plug (F) and oil level check plug (G) and securely tighten them.

**[2] OIL LEVEL CHECK AND REFILLING IN WINCH REDUCTION GEAR CASE**

**⚠ WARNING**

- Various parts are at elevated temperatures immediately after stopping the engine operation. Do not check oil level immediately. Wait until the oil is cooled.
- If there remains a residual internal pressure of the case, the oil and the plug may jump out. Accordingly, slowly loosen the plug to relieve the pressure.

**CAUTION**

- See “MAINTENANCE 7.1 USE OF FUEL AND LUBRICATING OIL ACCORDING TO TEMPERATURES” for the oil to be used.
- Use seal tape, etc. to the thread of the oil level check plug to stop oil leaks and securely tighten the plug after checking/refilling the oil.

- Prepare a container to receive spent oil.
  - Have a hexagonal wrench available.
1. Stop the Machine on flat and solid ground, raise the boom to approximately 80 degrees.
  2. By using a hexagonal wrench, remove the oil level check plug (G) and ensure that the level is within the normal range from the lower end of the plug opening to 10mm below.
  3. If the oil level is low, remove the oil inlet plug (F) and feed oil through the plug hole.

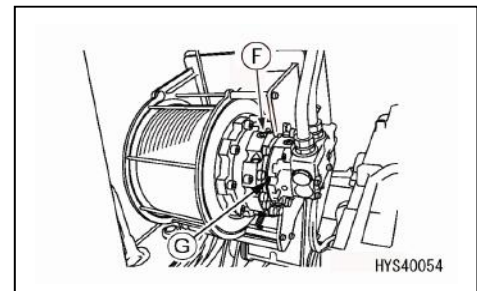

**NOTES**

- Fill the oil until it overflows from the oil level check plug hole (G).
- Wipe clean any spilt oil.

4. After checking and refilling oil, mount the oil inlet plug (F) and oil level check plug (G) and securely tighten them.

**[3] CHECKING/ADJUSTING FAN BELT TENSION  
[TENSION CHECK]**

1. Open the machinery cover (1).

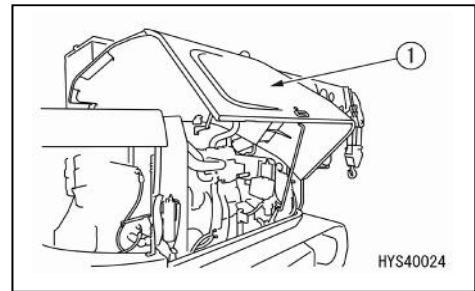

2. Push the middle portion of the belt between alternator pulley (2) and fan pulley (3) with thumb (approximately 98N·m [10kgf·m]) to ensure that the deflection (a) is in the standard range of 8.3 to 9.3mm.
  - When measuring the sagging by using a sonic tensiometer, it is normal if the value is within the range 101 to 113Hz.

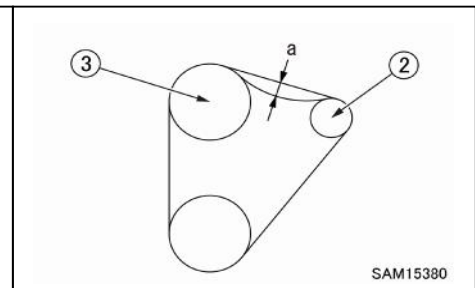
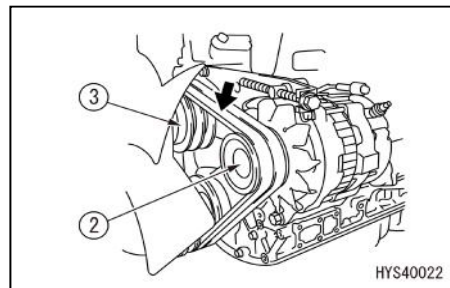

**[TENSION ADJUSTMENT]**

1. Loosen the mounting bolts (5) of alternator (4).
2. Remove the alternator lock nut (6).
3. Turn the adjuster bolt (7) of alternator (2) toward the loosening direction to adjust the belt tension so that it shows a sagging deflection of 8.3 to 9.3mm (approximately 98N·m [10kgf·m]).
4. Tighten the mounting bolt (5) and lock nut (6).

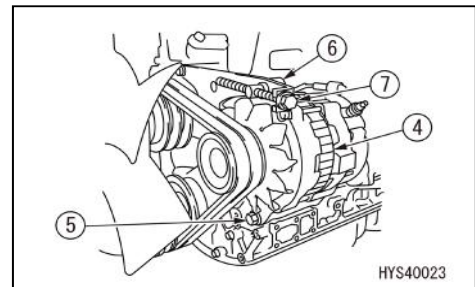

Tightening torque

- M8 bolt: 23.5N·m [2.4kgf·m]
- M10 bolt: 48.0N·m [4.9kgf·m]

5. Close the machinery cover (1).

**CAUTION**

**When checking the tension of fan belt, check the following at the same time:**

- Check pulley, V groove and belt for damage and wear. In particular, make sure that the belt is not in contact with the bottom of V groove.
- If the belt has been stretched to leave no allowance for adjustment or it gives off a slipping/squeaking sound, contact us or our sales agency for repair.

#### [4] CHECKING/ADJUSTING AIR-COMPRESSOR BELT TENSION

##### [TENSION CHECK]

1. Open the machinery cover (1).

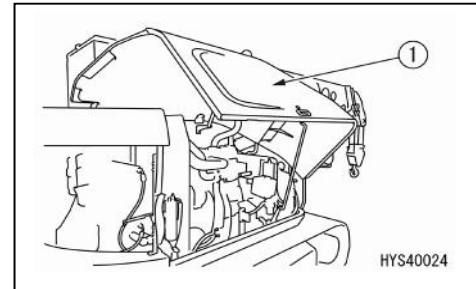

2. Press down on the middle of the belt (A) between the crank pulley (2) and the compressor pulley (3) with your thumb (approximately 17.7 N [1.8 kgf]) and confirm that the deflection is the standard value of 4 mm.

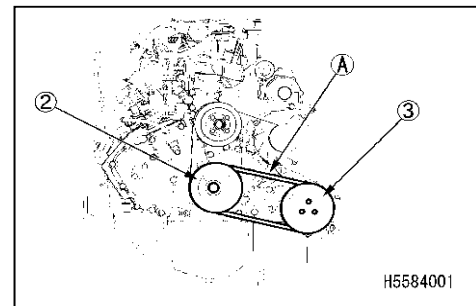

##### [TENSION ADJUSTMENT]

1. Loosen bolts (4), (7), and (8).

NOTES
Only loosen bolts (4), (7), and (8); do not remove. Removing them will make it impossible to position the adjustment bracket (6).

2. Tighten or loosen bolt (5) and press down on the middle of the belt (A) between the crank pulley (2) and the compressor pulley (3) with your thumb (approximately 17.7 N [1.8 kgf]). Adjust the adjustment bracket (6) position to ensure that the deflection (A) is 4 mm.

NOTES
Tightening bolt (5) increases the belt tension. Loosening the bolt decreases the belt tension.

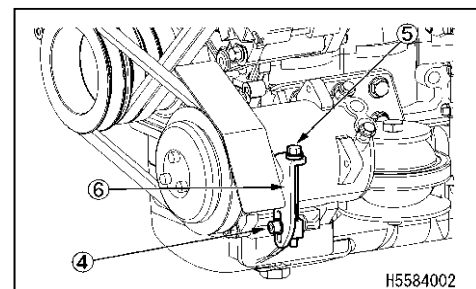

3. Tighten bolts (4) and (7) to secure the adjustment bracket (6).

Tightening torque: 27 N·m [2.8 kgf·m]

4. Tighten bolt (8) to secure the compressor.

Tightening torque: 53 N·m [5.4 kgf·m]

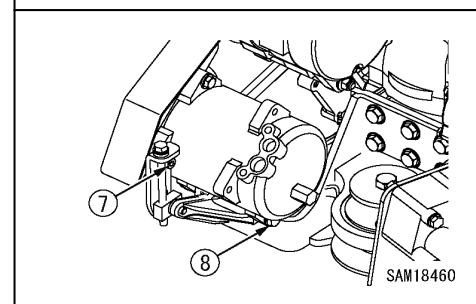

### CAUTION

When checking the tension of air-compressor belt, check the following at the same time:

- Check pulley, V groove and belt for damage and wear. In particular, make sure that the belt is not in contact with the bottom of V groove.
- If the belt has been stretched to leave no allowance for adjustment or it has scratches and cracks and gives off a slipping/squeaking sound, replace the belt.
- After replacing the V belt, conduct the adjustment again after running the Machine for an hour.

## 10.6 MAINTENANCE EVERY 500 HOURS

Perform this maintenance in tandem with maintenance every 50 and 250 hours.

### [1] REPLACING OIL IN ENGINE OIL PAN AND REPLACING ENGINE OIL FILTER CARTRIDGE

#### **⚠ WARNING**

Various parts are at elevated temperatures immediately after stopping engine operation. Do not proceed with oil or filter cartridge replacement immediately, but wait for the engine to cool so that you can touch it with your hand.

#### **CAUTION**

- See “MAINTENANCE 7.1 USE OF FUEL AND LUBRICATING OIL ACCORDING TO TEMPERATURES” for the oil to be used. Using oil other than those specified may shorten the life of the engine. Be sure to refill with the specified oil.
- Keep the engine oil at an appropriate level.
- When the engine is cold, oil cannot be thoroughly drained. Drain the oil when the engine has cooled down so that it can be touched by hand.
- Be careful not to let any foreign substance go into the filler opening when refilling the oil.

- Volume of replaced oil in the oil pan: 10 liters
  - Oil drain pan: Prepare a container of at least 15 litres.
  - Have a filter wrench available.
1. Remove the under cover of the Machine body and place a container to receive drained oil under the drain bolt (3).
  2. Loosen the drain bolt (3) slowly enough to prevent the drained oil from splashing.
  3. Open the machinery cover.
  4. By using the filter wrench, turn filter cartridge (2) counterclockwise to remove it.
  5. Clean the filter base, fill the new filter cartridge with clean oil, apply oil (or apply grease thinly) on the gasket and screws of the new filter cartridge, and mount the cartridge.

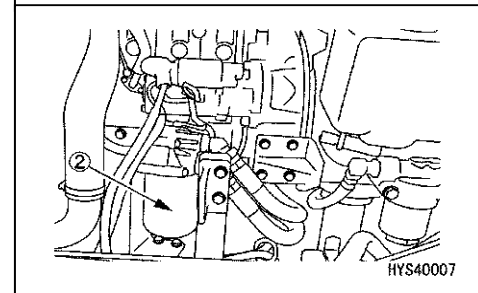
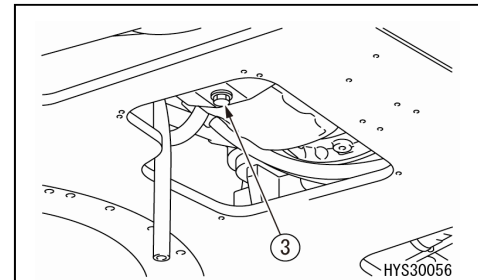

#### **NOTES**

- Make sure that old packing is not stuck to filter base. If the old gasket is stuck, it can cause oil leakage.
- When reinstalling the filter cartridge, tighten it 3/4 of a turn after the packing surface touches the sealing surface of the filter base.



6. After replacing the filter cartridge, fill the oil through the oil inlet (F) to the level within the range "H-L" marked on the level gauge (G).
7. After starting the engine and allow it to run at an idling revolution speed for a while, stop the engine to ensure that the oil level remains within the range "H-L" marked on the level gauge, while referring to the description under "OPERATION 3.1.2 [2] CHECKING OIL LEVEL AND REFILLING OIL IN ENGINE OIL PAN".

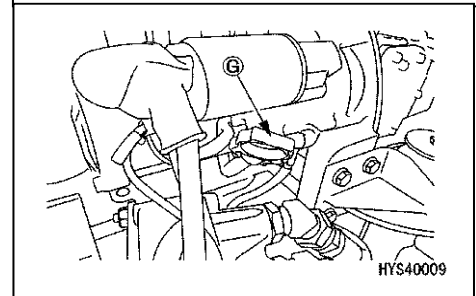
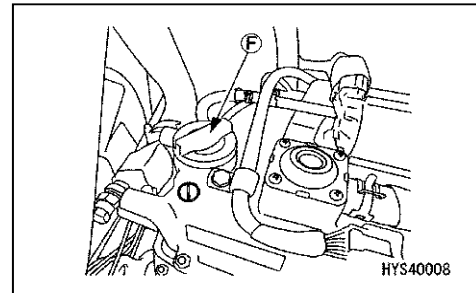



## [2] CHECKING/REFILLING SWING PINION GREASE AMOUNT

- Have a scale (rule) available.
- 1. Remove bolts of tank cover (1) and post cover (2) to take off the cover.
- 2. Remove the rubber plug (3) on the top of the frame.
- 3. Insert a scale (rule) into the grease in the pinion passing zone to ensure that its level is at a height of 4mm or more. If it is not enough, refill the grease.
- 4. Ensure that the grease is not contaminated or white. If any white or contamination is detected, the grease must be replaced. Contact us or our sales service agency for the replacement.  
Total grease quantity: 5.5 liters.  
Mount the rubber plug.
- 5. Attach the tank cover (1) and post cover (2).

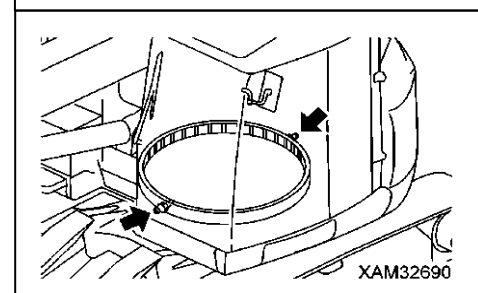
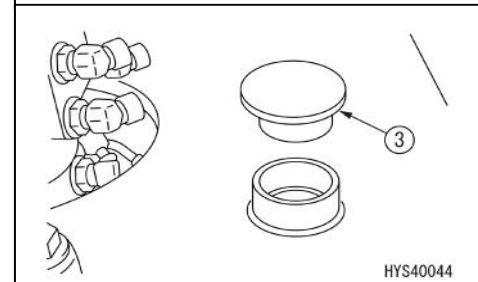
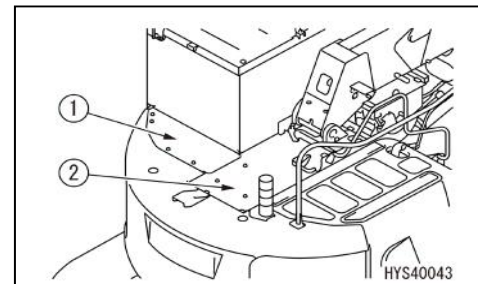

## [3] GREASING SWING CIRCLE

1. Inject grease with a grease gun through the arrow-marked grease plug shown in the sketch at right.
2. Wipe off old grease squeezed out after greasing.



**[4] CHECKING/CLEANING RADIATOR FINS, OIL COOLER FINS, AFTER COOLER FINS AND AIR-CONDENSER FINS**

**⚠ WARNING**

There is a risk to the human body if directly subjected to compressed air, pressurized water or steam and the use of them may cause scattering of dust, resulting in an accident. Wear goggles, dust mask and other protective equipment.

**CAUTION**

When using compressed air, keep a distance to avoid damage to the fins. Spray the compressed air onto the core at the closest possible angle to the perpendicular direction of its surface. Damage on the fins will cause water leakage or overheating.

On a dusty work site, conduct the daily inspection regardless of the specified servicing interval.

1. Open the right cover.
2. Remove the butterfly screw (1) (4 spots), and remove nets (2), (3) and (4).
3. Inspect the front and back sides of oil cooler fins (5), radiator fins (6), after cooler fins (7), and air-conditioner fins (8), and if any dirt, dust or tree leaves are stuck on them, blow them off by using compressed air.

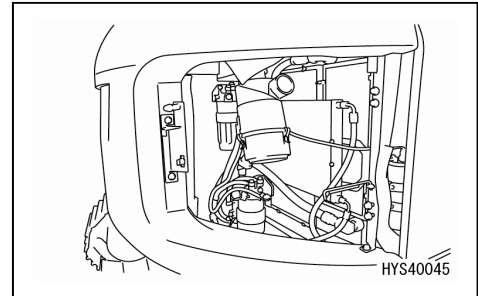

**NOTES**

Compressed air may be substituted by steam and water. However, when applying a strong steam cleaning (such as high-pressure car washer) to the heat-exchanger (radiator, oil cooler, after cooler, fuel cooler and air-conditioner), keep a sufficient distance for cleaning. Applying steam cleaning (for high-pressure car washing) from an extremely short distance may cause deformation of the internal fins of a heat-exchanger, early clogging, or even damage of them.

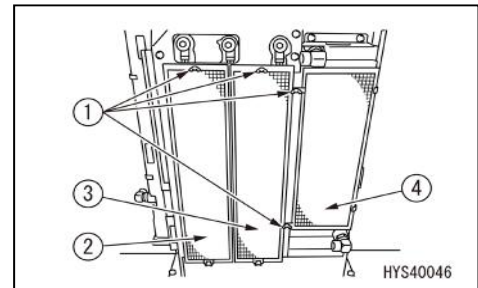

4. Check rubber hoses and replace those cracked or having become brittle, and also check the hose clamps for any loosening.
5. After completing the inspection and cleaning, mount the nets (2), (3) and (4) to the original positions.

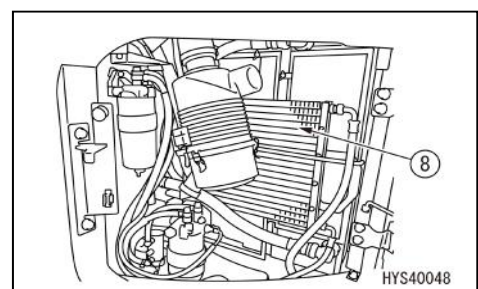
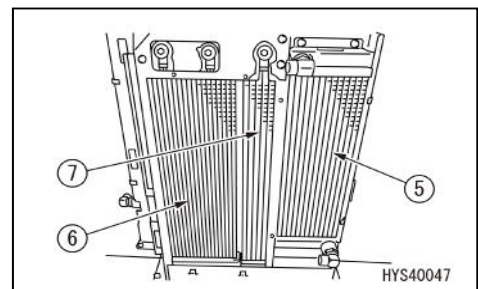

**[5] CLEANING AIR-CONDITIONER OUTDOOR/INDOOR AIR FILTERS**

**⚠ WARNING**

- There is a risk to the human body if directly subjected to compressed air, pressurized water or steam and the use of them may cause scattering of dust, resulting in an accident. Wear goggles, dust mask and other protective equipment
- Check the slide door to ensure that it is always locked when opened or closed, and clean the outdoor/indoor filters. If the door begins to move in a free state, it may catch your body or break the cover.

**CAUTION**

- Since the interval of 500 hours is a mere target indication, shorten it for dusty work sites.
- When cleaning floors, be cautious not to subject them to water splashes.

**[CLEANING THE INDOOR FILTER]**

1. Pull out the indoor filter (1).
2. Clean the indoor filter (1) with compressed air.  
If the indoor filter (1) is smeared with oil or heavily contaminated, clean it with neutral detergent.  
After water cleaning, dry it thoroughly before using it.

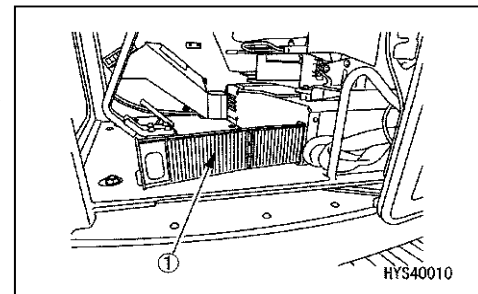

**NOTES**

If clogging of the filter cannot be removed with compressed air or by water washing, replace it with a new one.

3. Return the cleaned indoor filter (1) to its original position.

**[CLEANING THE OUTDOOR FILTER]**

1. Unlock the cover (1) in the rear of operator's cabin by using the key (the starter key).
2. Open the cover (1) by hand and take out the outdoor filter (2) contained in it.
3. Clean the outdoor filter (2) with compressed air.

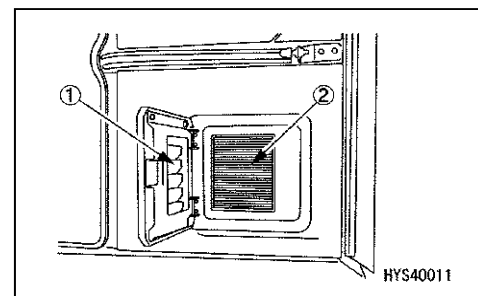

**NOTES**

Replace the filter when clogging of it frequently occurs or at intervals of one year.

4. Put the cleaned outdoor filter (2) in its original position and close cover (1).
5. Lock the cover by using the key (starter key).  
Do not forget to pull out the key.

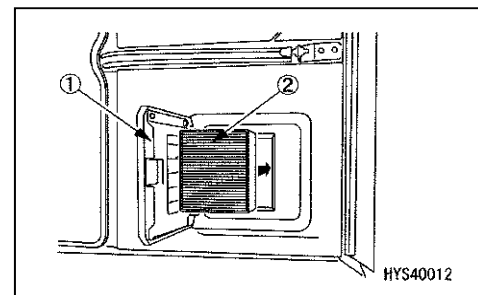

**[6] REPLACEMENT OF HYDRAULIC OIL TANK BREATHER ELEMENT**

**⚠ WARNING**

- Various parts are at elevated temperatures immediately after stopping the engine operation. Do not replace the elements immediately. Wait until the oil is cooled.
- When removing the oil inlet cap, turn it slowly to relieve the internal pressure in order to prevent the oil from spurting out.

1. Loosen the bolts to remove the cover (1) on top of the hydraulic oil tank.

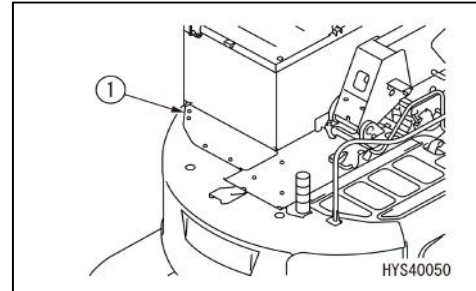

2. Remove the cap of oil inlet (F) to relieve the internal pressure.

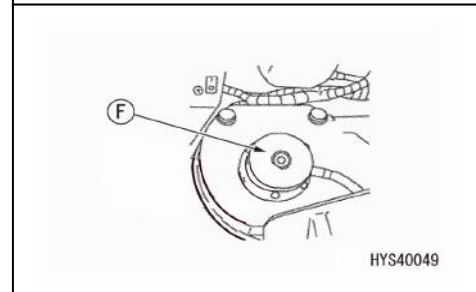

3. Replace the element (2) inside the cap.

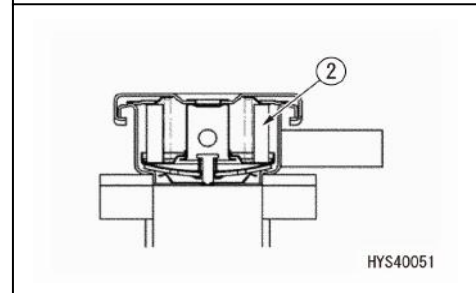

4. Mount the cap of oil inlet (F).

5. Attach the cover (1) on top of the hydraulic oil tank.

**[7] OIL REPLACEMENT IN WINCH REDUCTION GEAR CASE**

★ Perform the replacement in the initial servicing for the new Machine. Afterwards conduct the replacement every 1000 hours.

Refer to the description under "10.7 MAINTENANCE EVERY 1000 HOURS" for maintenance places and procedure.

## [8] REPLACING THE FUEL PRE-FILTER CARTRIDGE

### ⚠ WARNING

- Various parts are at elevated temperatures immediately after stopping the engine operation. Do not proceed with fuel filter replacement immediately but wait for the engine to cool to the extent that you can touch it with your hand.
- In the engine fuel piping, an internal pressure is generated during engine operation. Before replacing the filter, wait for 30 seconds or more after stopping the engine to allow the internal pressure to drop, and then replace the filter.
- Be extremely careful of fire such as cigarettes when replacing the fuel filter elements.

### CAUTION

- The genuine fuel filter cartridge employs a special filter having a high-efficiency filtering characteristic. Always use Maeda genuine filters for the replacement.
- The common rail type fuel injection system employed in the Machine consists of parts that are higher precision than that of conventional injection pumps and nozzles. Substituting the fuel filter cartridge with any products other than the genuine product may give rise to inclusion of foreign matters and failures in the fuel system. Never use any substitutes.
- When conducting the inspection and maintenance services of the fuel system, pay more attention to the inclusion of foreign matters than that paid for conventional products, and if rubber or other objects are deposited, use the fuel to thoroughly clean it.

- Prepare a container to receive spent oil.
- Have a filter wrench available. (Optional product: Part No. 585-3554500)

1. Open the right cover.
2. Set the oil receiving container under the fuel prefilter cartridge.
3. Loosen the drain plug (1) and air-venting plug (2) to thoroughly drain the fuel in the filter.
4. By using the filter wrench, turn filter cartridge (3) counterclockwise to remove it.

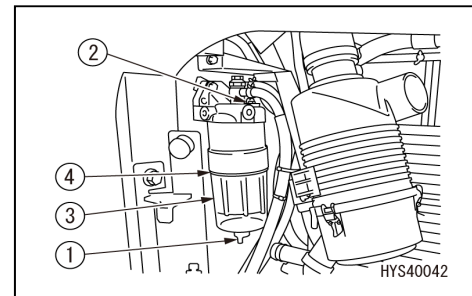

5. Attach a new case (3).  
At that stage, be sure to replace the O-ring (4) with a new one.
6. When attaching the new filter case (3) thinly apply oil on the gasket, and after allowing it to come in contact with the sealing face, tighten it with the filter wrench.  
Tightening torque: 30.0N·m (5.1kgf·m). Drain plug tightening torque: 2.0N·m (0.2kgf·m).
7. Clean the filter, fill the new filter cartridge with clean fuel, thinly apply oil on the gasket, and mount the cartridge on the filter base.
8. After replacing the filter cartridge (4), vent the air.

### [VENTING AIR IN THE FUEL SYSTEM]

Refer to the description under "OPERATION 8.1 WHEN FUEL RUNS OUT".

**[9] REPLACING THE MAIN FUEL FILTER CARTRIDGE**

**⚠ WARNING**

- Various parts are at elevated temperatures immediately after stopping the engine operation. Do not proceed with fuel filter replacement immediately but wait for the engine to cool to the extent that you can touch it with your hand.
- In the engine fuel piping, an internal pressure is generated during engine operation. Before replacing the filter, wait for 30 seconds or more after stopping the engine to allow the internal pressure to drop, and then replace the filter.
- Be extremely careful of fire such as cigarettes when replacing the fuel filter elements.

**CAUTION**

- The genuine fuel filter cartridge employs a special filter having a high-efficiency filtering characteristic. Always use Maeda genuine filters for the replacement.
- The common rail type fuel injection system employed in the Machine consists of parts that have higher precision than that of conventional injection pumps and nozzles. Substituting the fuel filter cartridge with any products other than the genuine product may give rise to inclusion of foreign matters and failures in the fuel system. Never use any substitutes.
- When conducting the inspection and maintenance services of the fuel system, pay more attention to the inclusion of foreign matters than that paid for conventional products, and if rubber or other objects are deposited, use the fuel to thoroughly clean it.

- Prepare a container to receive spent oil.
- Have a filter wrench available. (Optional product: Part No. 585-3554500)

1. Open the right cover of the machine body.
2. Set the oil receiving container under the fuel filter cartridge.
3. Loosen the drain plug (1) and air-venting plug (2) to thoroughly drain the fuel in the filter.
4. By using the filter wrench, turn filter cartridge (3) counterclockwise to remove it.
5. Replace the filter case (3) and O-ring (4) of drain plug (1) with new ones, put the new element (5) in the filter case (3), thinly apply fuel on the O-ring (4), and screw it in.
6. After allowing the O-ring (6) to come into contact with the sealing face, tighten the setup by using the dedicated filter wrench.

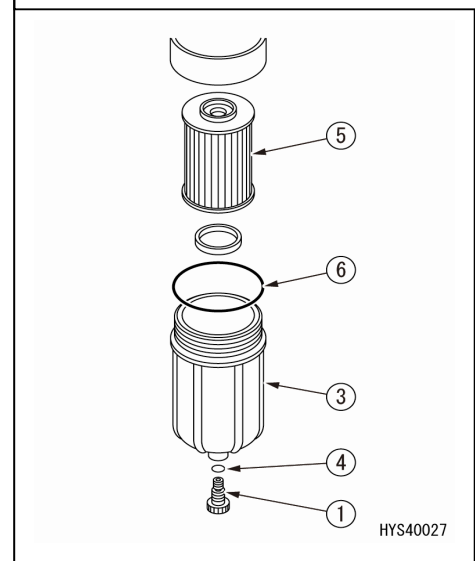
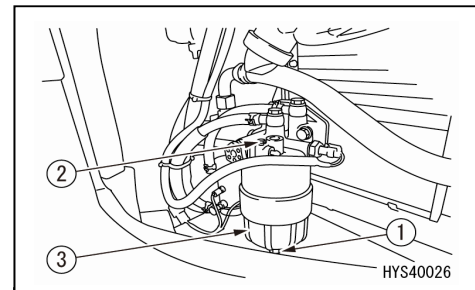

**CAUTION**

- If any foreign matter or dirt is found on the bottom of the filter case, clean it.
- Reusing the element will invite trouble. Never fail to replace it with a new one.

7. After replacing the filter cartridge, vent the air.

**[VENTING AIR IN THE FUEL SYSTEM]**

Refer to the description under "OPERATION 8.1 WHEN FUEL RUNS OUT".

**[10] REPLACING THE FUEL FEED PUMP FILTER**

**⚠ WARNING**

- Since the pump has residual fuel, receive the fuel in a pan before removing it, while paying attention not to allow the fuel to splash on the engine. Also, be cautious of any fire.

**CAUTION**

- After removing the filter, be sure to replace the gasket and clean the magnet inside the cover.

1. Open the right cover.
2. Disengage the harness connector (2) of fuel feed pump (1).
3. Use a spanner to turn the cover (3) and take it off.
4. Remove the filter (4) and gasket (5), and replace them.
  - For the paper type, replace with new filter (4) and gasket (5).
  - For the steel mesh type, wash the removed filter (4) with clean diesel fuel and blow dust off with high-pressure air. Then, mount the filter (4) and new gasket (5).

**NOTES**

- In the middle area inside the magnetic pump, do not disassemble the part (6) pertaining to the piston.
- When removing the gasket, pinch the perimeter of the gasket in such a way that it is being stretched.

5. Attach the cover (5). Use a spanner to securely tighten it.

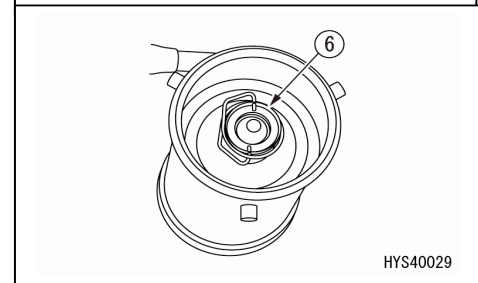
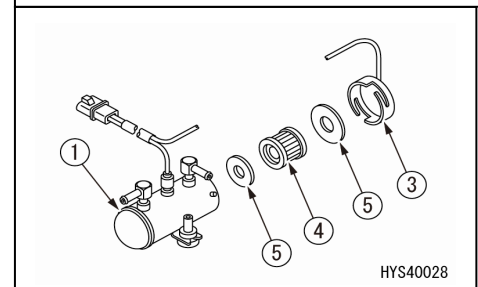
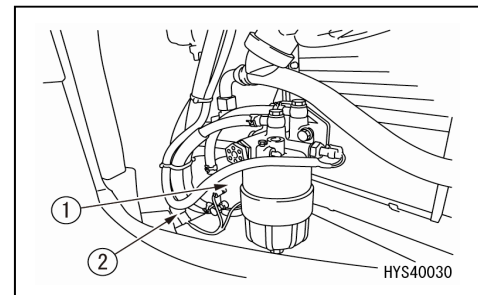



## 10.7 MAINTENANCE EVERY 1000 HOURS

Perform this maintenance in tandem with maintenance every 50, 250 and 500 hours.

### [1] OIL REPLACEMENT IN TRAVELLING MOTOR REDUCTION GEAR CASE

#### **⚠ WARNING**

- Various parts are at elevated temperatures immediately after stopping the engine operation. Do not change the oil immediately. Wait until the oil has cooled.
- If there remains a residual internal pressure in the case, the oil and the plug may jump out. Accordingly, slowly loosen the plug to relieve the pressure.

#### **CAUTION**

- See “MAINTENANCE 7.1 USE OF FUEL AND LUBRICATING OIL ACCORDING TO TEMPERATURES” for the oil to be used.
- After replacing oil, use sealing tape, etc. on the thread of each plug to stop the oil leaking and securely tighten the plugs.

- Volume of replaced oil: 2.1 liters each for left and right tanks
  - Prepare a container to receive spent oil.
  - Have a hexagonal wrench available.
1. Move the Machine back and forth to align the oil feeding inlet plug (F) and drain plug (P) in the vertical position to the ground.
  2. Set a container to receive spent oil under drain plug (P).
  3. Use a hexagonal wrench to remove the oil level check plug (G) and drain plug (P) and drain the oil.
  4. After draining oil, refit the drain plug (P) and securely tighten it.
  5. Pour the amount of oil required for replacement through the oil inlet plug opening (F).
  6. When the oil begins to overflow from the oil level check plug opening (G), refit the oil level check plug (G) and oil inlet plug (F) and securely tighten them.

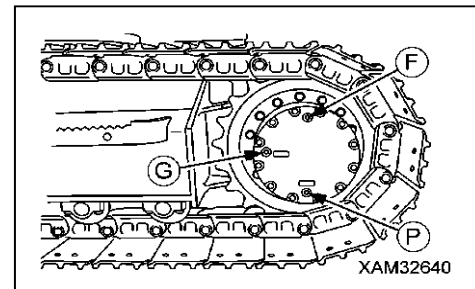



## [2] OIL REPLACEMENT IN WINCH REDUCTION GEAR CASE

### ⚠ WARNING

- Various parts are at elevated temperatures immediately after stopping the engine operation. Do not check oil level immediately. Wait until the oil is cooled.
- If there remains a residual internal pressure in the case, the oil and the plug may jump out. Accordingly, slowly loosen the plug to relieve the pressure.

### CAUTION

- See “MAINTENANCE 7.1 USE OF FUEL AND LUBRICATING OIL ACCORDING TO TEMPERATURES” for the oil to be used.
- After replacing oil, use sealing tape, etc. on the thread of each plug to stop the oil leaking and securely tighten the plugs.

- Volume of replaced oil: 1.8 liters
  - Prepare a container to receive spent oil.
  - Have a hexagonal wrench available.
1. Stop the Machine on flat and solid ground, raise the boom to approximately 80 degrees.
  2. Set a container to receive spent oil under drain plug (P).
  3. Use a hexagonal wrench to remove the oil level check plug (G) and drain plug (P) and drain the oil.
  4. After draining oil, refit the drain plug (P) and securely tighten it.
  5. Pour the amount of oil required for replacement through the oil inlet plug opening (F).
  6. When the oil begins to overflow from the oil level check plug opening (G), refit the oil level check plug (G) and oil inlet plug (F) and securely tighten them.

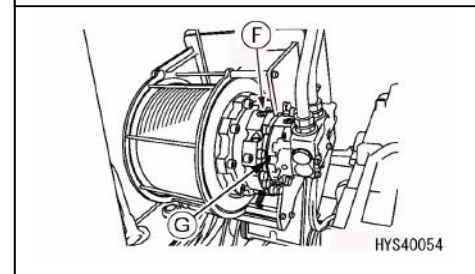
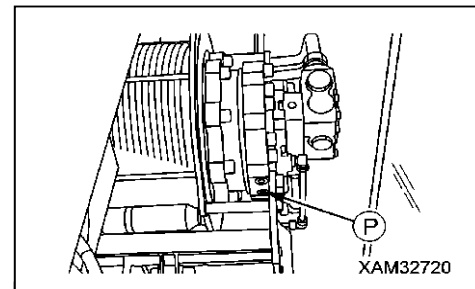

### [3] REPLACEMENT OF HYDRAULIC OIL RETURN FILTER CARTRIDGE

#### ⚠ WARNING

- Various parts are at elevated temperatures immediately after stopping the engine operation. Do not replace the elements immediately. Wait until the oil is cooled.
- The oil may spurt out when the filler cap of the hydraulic oil tank is removed. To relieve the internal pressure, slowly turn the oil inlet cap.

#### CAUTION

- Refer to the description under "MAINTENANCE 7.1 USE OF FUEL AND LUBRICATING OIL ACCORDING TO TEMPERATURES" for the oil to be used.
- After replacing the filter elements of hydraulic oil, do not start the engine for a while until piping and hydraulic equipment are filled with the oil.

- Prepare a container to receive spent oil.
  - Have a filter wrench available.
1. Retract the hook block in the simplified retracting recess and set the Machine to the "travelling posture" as shown in the sketch on the right.

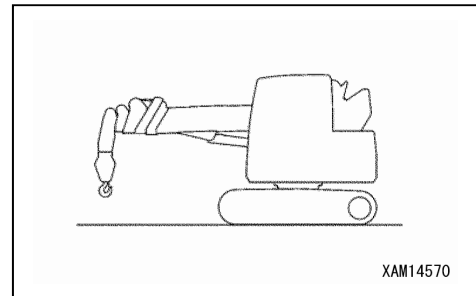

2. Loosen the bolts to remove the cover (1) on top of the hydraulic oil tank.

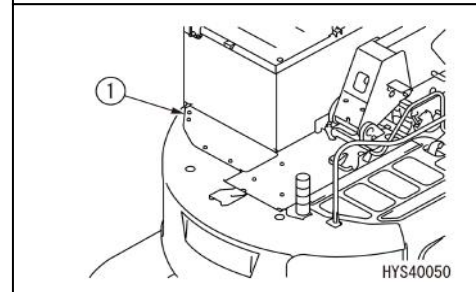

3. Remove the cap of oil inlet (F) to relieve the internal pressure.

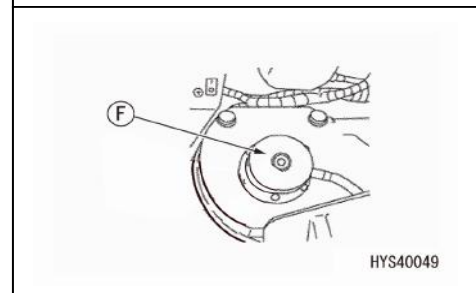

4. Open the cover on the left side and insert the rod in the groove to fix it.
5. Using the filter wrench, turn the filter (2) counterclockwise to remove it.

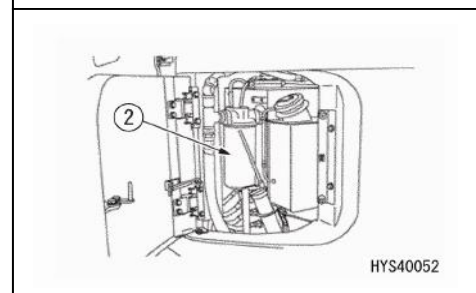



6. Clean the filter base, thinly apply oil on the gasket face of the new filter and refit it on the filter base.
7. When reinstalling the filter cartridge, tighten it for 3/4 of a turn after the gasket face comes in contact with the sealing face of the filter base.

<b>NOTES</b>
<ul style="list-style-type: none"><li>• Excessive tightening of filter cartridge may damage the gasket mating surface, leading to the leakage of fuel. Also a loose fitting may cause fuel leakage around the gasket. Always observe the tightening angle.</li><li>• When using a filter wrench for the tightening, pay adequate attention not to generate scratches and dents on the filter.</li></ul>



8. Attach the cover (1) on top of the hydraulic oil tank.
9. To ensure air venting, run the engine at idle for 10 minutes after starting it.
10. Stop the engine.

<b>NOTES</b>
<p>After stopping the engine let it stand still for 5 minutes or more before restarting. This allows the air bubbles entrapped in the oil of the hydraulic oil tank to discharge into the atmosphere.</p>



11. Check for any oil leakage, and cleanly wipe off any spilt oil.

#### [4] REPLACING THE HYDRAULIC OIL LINE FILTER ELEMENT

### ⚠ WARNING

- Various parts are at elevated temperatures immediately after stopping the engine operation. Do not replace the filter immediately. Wait until the oil is cooled.
- The oil may spurt out when the filler cap of the hydraulic oil tank is removed. To relieve the internal pressure, slowly turn the oil inlet cap.

### CAUTION

- Refer to the description under "MAINTENANCE 7.1 USE OF FUEL AND LUBRICATING OIL ACCORDING TO TEMPERATURES" for the oil to be used.

- Prepare a container to receive spent oil.
  - Have a filter wrench available.
1. Retract the hook block in the simplified retracting recess and set the Machine to the "travelling posture" as shown in the sketch on the right.
  2. Open the engine hood and securely lock it with the hood support lever.

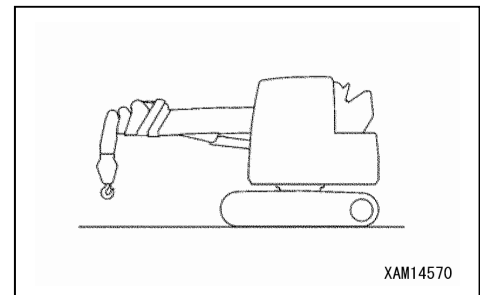

3. Set a container to receive spent oil under the filter element.

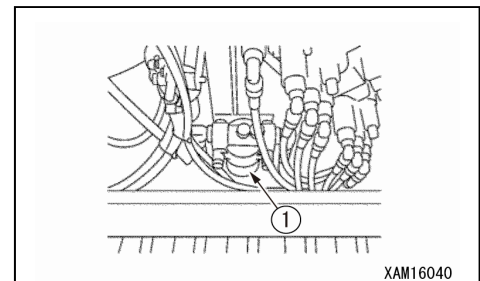

4. Turn the filter case (4) counterclockwise and remove the element (2) and O-ring (3) from the filter base (4).
5. Clean the filter base (4) and filter case (1), apply clean hydraulic oil on the gasket of new element (2), and mount them on the filter base (4) together with the O-ring (3).  
In that stage, be sure to replace the O-ring (3) with a new one.
6. Fill the filter case (1) with clean hydraulic oil and mount it on the filter base (4).  
When reinstalling the filter cartridge, tighten it for 1/2 of a turn after the filter case (1) comes in contact with the sealing face of the filter base (4).

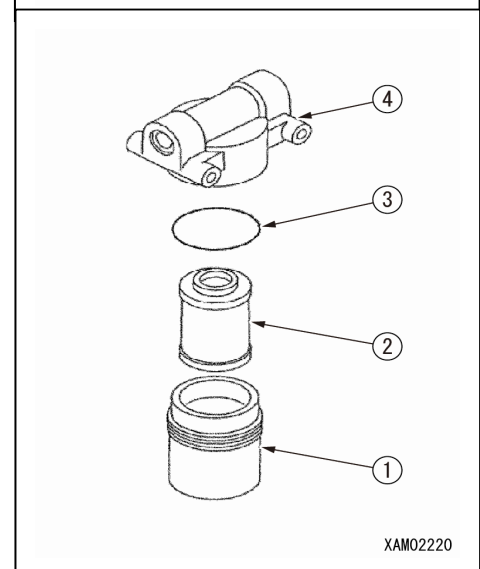

### NOTES

- Make sure that the old O-ring is not stuck to filter base (4). Otherwise, it may cause an oil leakage.

**[5] CHECKING ALTERNATOR AND STARTER**

The brushes may wear down or a loss of grease in a bearing. Contact us or our sales service agency to request for inspection and repair.

**[6] INSPECTION/ADJUSTING ENGINE VALVE CLEARANCE**

Since special tools are required for the inspection and adjustment, request us or our sales agency for the servicing.

**[7] MEASURING COMPRESSION PRESSURE**

Since special tools are required for the measurement, request us or our sales agency for the servicing.

**10.8 MAINTENANCE EVERY 1500 HOURS****[1] CLEANING EGR COOLER**

Since special tools are required for the cleaning, request us or our sales agency for the servicing.

**10.9 MAINTENANCE EVERY 3000 HOURS****[1] CHECKING/CLEANING EGR VALVE**

Since special tools are required for the Checking and cleaning, request us or our sales agency for the servicing.

## 10.10 MAINTENANCE EVERY 4000 HOURS

Perform this maintenance in tandem with maintenance every 50, 250, 500 and 1000 hours.

### [1] INSPECTION OF WATER PUMP

Check the pulleys for play, oil leakage, water leakage and drain hole clogging. If any fault is found, request us or our sales agency for the dismantling and repair.

### [2] REPLACING THE ACCUMULATOR

Replace the accumulator every 2 years or 4000 hours of service, whichever falls first.

#### **⚠ WARNING**

Since the accumulator is charged with high pressure nitrogen gas, any incorrect handling of it may cause an explosion and therefore cause a serious accident. Strictly observe the following for handling:

- The pressure in the hydraulic circuit cannot be totally relieved. When removing a hydraulic unit, stay away from the escaping oil direction. Also, loosen screws slowly.
- Never disassemble them.
- Do not allow fire to come close to them or throw them into a fire.
- Do not attempt drilling, or gas cutting.
- Do not knock them, drop them or give an impact to them.
- When disposing of them, removal of filled gas is required. Contact us or our sales service agent.

Continuing to operate with the accumulator remaining at a low level of functions will result in failure. It cannot relieve its residual pressure when the Machine is in trouble.

Contact us or our sales service agency for the replacement.

The accumulator is installed in the position indicated in the sketch at the right.

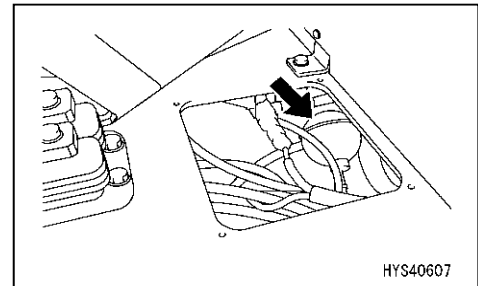

## 10.11 MAINTENANCE EVERY 5000 HOURS

Perform this maintenance in tandem with maintenance every 50, 250, 500 and 1000 hours.

### [1] REPLACING OIL IN HYDRAULIC OIL TANK AND CLEANING STRAINERS

#### **⚠ WARNING**

- Various parts are at elevated temperatures immediately after stopping the engine operation. Do not remove the strainer immediately. Wait until the oil is cooled.
- The oil may spurt out when the filler cap of the hydraulic oil tank is removed. To relieve the internal pressure, slowly turn the oil inlet cap.

#### **CAUTION**

- Refer to the description under "MAINTENANCE 7.1 USE OF FUEL AND LUBRICATING OIL ACCORDING TO TEMPERATURES" for the oil to be used.
- Be sure to put the machine in the travelling posture when checking the oil level. If you check the oil level in the working posture, you judge the oil level to be low and feed the oil excessively.
- After replacing the oil, do not start the engine for a while until piping and hydraulic equipment are filled with the oil.

- Volume of replaced oil: 81 liters
  - Prepare a container to receive spent oil.
  - Have a filter wrench available.
1. Retract the hook block in the simplified retracting recess and set the Machine to the "travelling posture" as shown in the sketch on the right.

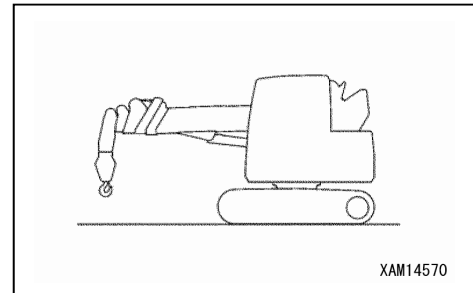

2. Turn the upper slewing body so that the drain plug under the hydraulic oil tank comes between the left and right rubber tracks.
3. Set the lock lever to the lock position, and stop the engine.

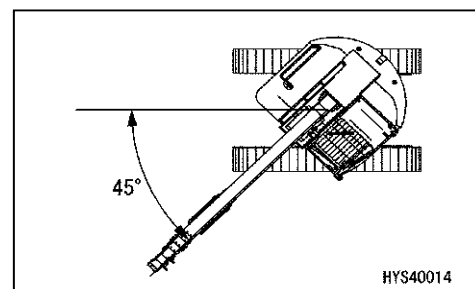

4. Loosen the bolts to remove the cover (1) on top of the hydraulic oil tank.

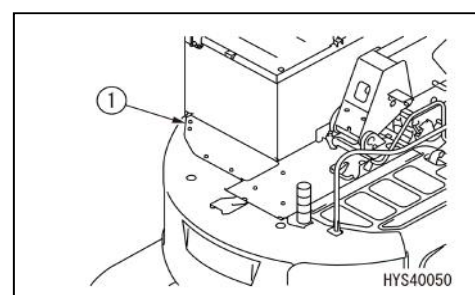

5. Remove the cap of oil inlet (F) to relieve the internal pressure.

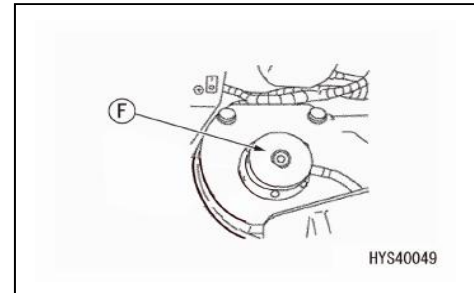

6. Set a container to receive spent oil beneath the drain plug on the bottom side of the Machine body.

7. Remove the drain plug (P) slowly to avoid splashing oil on yourself, and drain the oil.

8. Check the O-ring mounted in the drain plug (P), and if a scratch is found, replace it with a new one.

9. After draining oil, refit the drain plug (P), and tighten it. Tightening torque: 58.8 to 78.4N·m (6 to 8kgf·m)

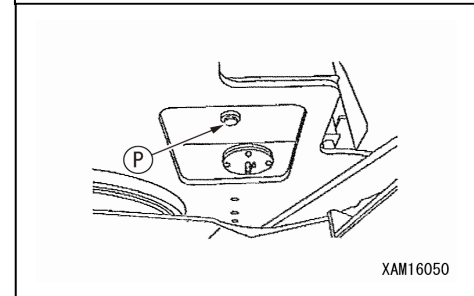

10. Remove the bolt (4) and cover (5). At this stage, the cover may jump off because of the spring (6), keep pressing the cover down, while removing the bolts.

11. Lift up the upper end of rod (7) from above to take out the spring (6) and strainer (8).

Remove dust stuck to strainer (8) and wash it with clean diesel fuel or washing oil.

If any damage is found in the strainer (8), replace it with a new one.

12. For assembling, insert the strainer (8) into the protruding part (9) of the tank.

13. Set the cover (5), and while pushing it with hands, mount the cover (5) with bolts (4).

Check the O-ring mounted on the cover, replace it if it is scratched.

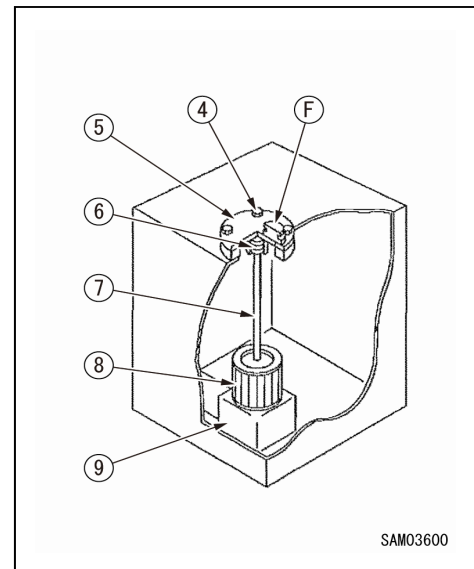

14. Pour the specified amount of oil through oil inlet (F). Check to ensure that the level is within the range H-L on the sight gauge.

For details of checking oil level, refer to the description under "OPERATION 3.1.2 CHECKING BEFORE STARTING ENGINE, item [4] " CHECKING OIL LEVEL AND REFILLING OIL IN HYDRAULIC OIL TANK ".





15. Set the boom in the completely retracted and fully raised state, fit the oil feed cap and pressurize the tank.

**CAUTION**

Omitting pressurization of the hydraulic tank causes the pump to suck air, resulting in adverse effect on the units.

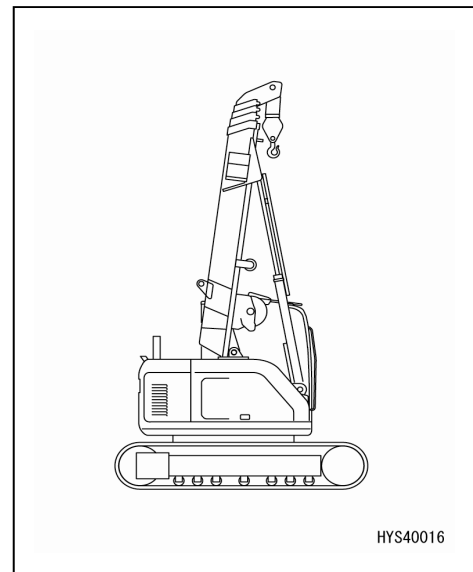

16. Attach the cover (1) on top of the hydraulic oil tank.
17. After replacing/cleaning the hydraulic oil, filter element, and strainer, vent the air in the circuit. For details of venting the hydraulic circuit, refer to the description under "MAINTENANCE 11 VENTING AIR IN HYDRAULIC CIRCUITS".



## 11. VENTING AIR IN HYDRAULIC CIRCUITS

### NOTES

For details of starting engine, refer to the description under "OPERATION 3.3 STARTING ENGINE". Refer to the description under the section of starting, stopping and changing direction of the Machine in the Operation volume as required.

### CAUTION

- After completion of air venting, stop the engine once to allow it to be standing still for 5 minutes, and then start the engine again. This process allows the air bubbles entrapped in oil tank to vent into the atmosphere.
- After completing the operation, check for any oil leakage, and cleanly wipe off spilt oil.

### [1] VENTING AIR IN PISTON PUMP

### CAUTION

Running the pump without filling the pump case with hydraulic will oil cause early damage of pump after giving off abnormal noise. Be sure to exercise the air venting.

1. Loosen the fitting (1) of port D of the pump to check if oil is oozing out through the fitting (1) (air venting completed).
2. After completion of air venting, tighten the fitting (1) of the port D of the pump.

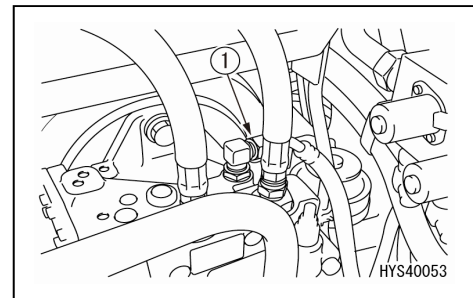

### [2] VENTING AIR IN CYLINDER

### CAUTION

Revvng the engine at the outset and allowing the cylinder to move to the stroke end may damage the piston packing or other parts because of air inclusion in the cylinder.

1. While allowing the engine to run at idle and not allowing the cylinder to reach the stroke end (stopping it approximately 100mm before the stroke end), repeat telescoping for 4 to 5 times.
2. Then, allow each cylinder to travel to their stroke end 3 to 4 times.
3. Again allow each cylinder to travel to their stroke end 4 to 5 times to vent the air thoroughly.

### [3] VENTING AIR IN WINCH MOTOR

#### ⚠ CAUTION

Before loosening and tightening the air venting plug of winch motor, be sure to allow the hook block to touch the ground and set the work machine operation lever to "NEUTRAL" position. Otherwise, the internal pressure may force the plug or oil to spurt out.

#### CAUTION

- Conduct the air venting of winch motor thoroughly. Insufficient air venting will hinder smooth operation of the motor at its start.
- Securely tighten the air vent plug. If it is loosened, the brake cannot be cancelled. Also, it may give rise to oil leakage.

#### [VENTING AIR IN THE MECHANICAL BRAKE]

1. Allow the hook block to touch the ground, and return the right work machine operating lever to "NEUTRAL" position.
2. Loosen the air vent plug (1) of mechanical brake for 3 to 4 turns.
3. Without hoisting a load, repeat the operation of slowly winding up the hook block, stopping and winding down.
4. If hydraulic oil is oozing out from air vent plug (1) of the mechanical brake, stop the winch operation and securely tighten the air vent plug (1).

★Tightening torque: 12.3N·m (1.25kgf·m)

#### [VENTING AIR IN THE COUNTER BALANCE VALVE]

1. Allow the hook block to touch the ground, and return the right work machine operating lever to "NEUTRAL" position.
2. Loosen the air vent plug (2) of counter balance valve for 3 to 4 turns.
3. Without hoisting a load, repeat the operation of slowly winding up the hook block, stopping and winding down.
4. If hydraulic oil is oozing out through the air vent plug (2) for counterbalance, allow the hook block to touch the ground and return the right work machine operation lever to "NEUTRAL" position.
5. Securely tighten the air vent plug (2).

★Tightening torque: 12.3N·m (1.25kgf·m)

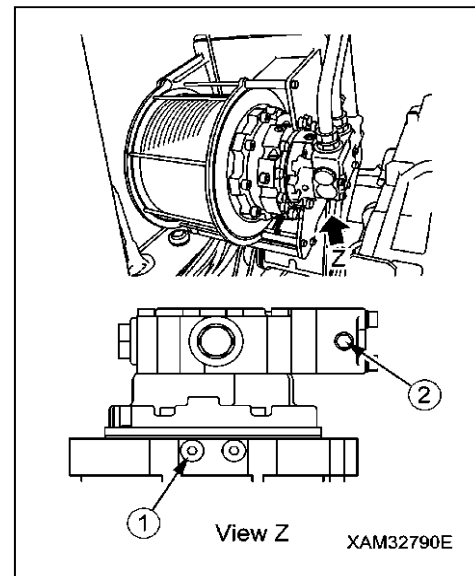

**[4] VENTING AIR IN TRAVELLING MOTOR**

<b>NOTES</b>
Conduct the air venting only when the oil in the travelling motor is drained.

1. Start the engine and run it at a low idling revolution speed.
2. Remove the hose of port C (3), and if oil is flowing out, tighten it.
3. Stop the engine once and float the footing by referring to the description on "Method for floating the footing" given below.
4. Start the engine again and run it at a low idling revolution speed.
5. Allow the rubber track on the floated side to run idle for 2 minutes.

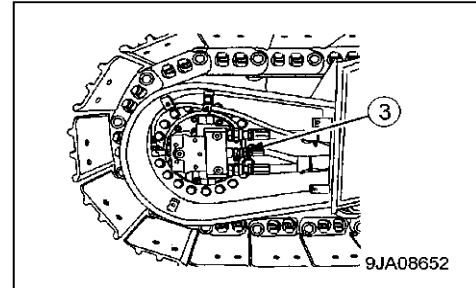

<b>NOTES</b>
<ul style="list-style-type: none"> <li>• When running the rubber tracks unloaded, move them back and forth equally.</li> <li>• Exercise the operations under items 3 to 5 for both left and right tracks.</li> </ul>

**[METHOD FOR FLOATING THE FOOTING BY USING THE CRANE]**

**⚠ WARNING**

- Conduct the operations on a flat and solid ground.
- For the dimensions and mass of this Machine, refer to the descriptions under "SPECIFICATIONS 1. PRINCIPLE SPECIFICATION LIST".
- A person who uses the crane to perform hoisting operation must have the crane operation qualifications.
- Only use a sling (e.g. wire rope and shackles) which is approved and capable of lifting the mass of the machine.
- When performing lifting work, place the lock lever at the lock position to prevent the machine from moving unexpectedly.
- Never hoist the Machine in any ways other than the following procedure. Otherwise, the Machine will be out of balancing.

• Prepare a square block (450mm by 450mm) that is to be put under the track frame.

1. Set the Machine to the "Travelling posture" in the right figure.
2. Slew the boom 90 degrees.

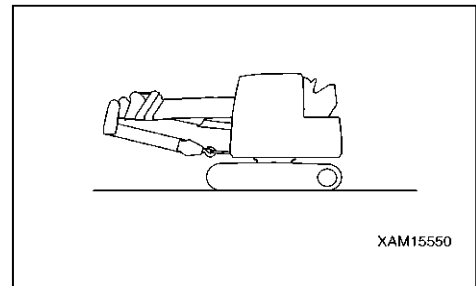

3. Apply a wire rope (A) to the boom and hoist the crane slowly.

### NOTES

In this step, to prevent the boom from being damaged, insert a pad (B) between the crane wire rope (A) and the boom.

4. Insert the packing block (C) that has been prepared between the floating track frame and the ground. Make sure it is well balanced.
5. Slowly lower the machine down onto the packing block.  
At this stage, whilst lowering down the machine, ensure that the machine is well stabilized.

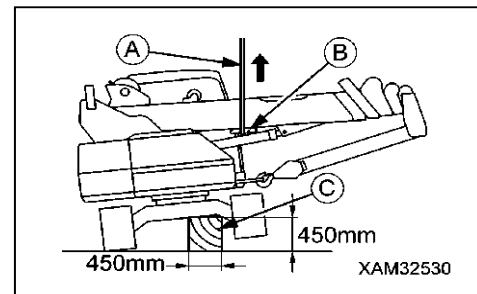

## 12. RELIEVING INTERNAL PRESSURE OF HYDRAULIC CIRCUIT

### ⚠ WARNING

- The pressure in the hydraulic circuit cannot be completely relieved. When removing a hydraulic unit, stay away from the oil flow direction. Also, loosen the screw slowly.

### CAUTION

Complete this procedure. After stopping the engine move the machine work ration lever back and forth as well as leftward and rightward using its full stroke for 15 seconds. Since the accumulator pressure gradually decreases after stopping the engine, the pressure can only be relieved immediately after stopping the engine.

1. Place the machine on horizontal and solid ground surface.
2. Turn the starter switch to "OFF" position to stop the engine.
3. Turn the starter switch to "ON" position.
4. Set the lock lever (1) to "FREE" position (F), and operate the machine work operation lever back and forth as well as leftward and rightward for its full stroke to relieve the residual pressure in the hydraulic circuit.
5. Set the lock lever (1) to "LOCK" position (L), and lock the machine work operation lever.

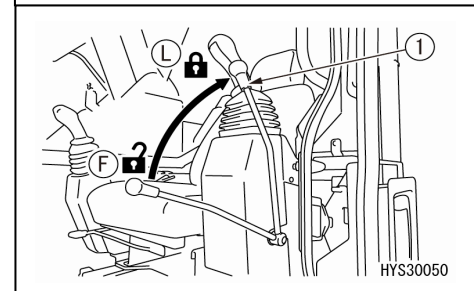
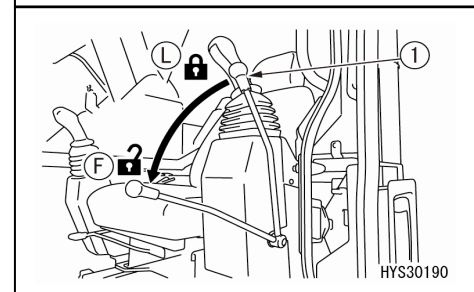
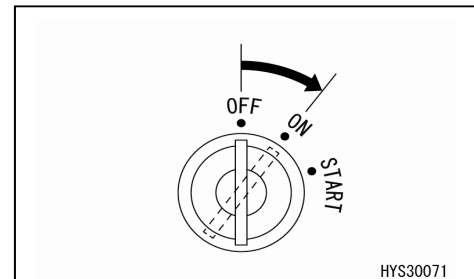

## 13. ATTACHING/DETACHING SINGLE-FALL HOOK

### ⚠ WARNING

- The rope wedge used to secure the wire rope must be correctly attached. Improper attachment may result in the wire rope coming loose and falling out during crane work and serious accidents.
- Be sure to mount the overwinding prevention device securely. If the device does not function correctly, the hook or load may fall resulting in serious accidents.
- Always wear heavy leather work gloves when handling the wire rope.

### CAUTION

The single-fall hook block is optional. To purchase, contact us or our sales service agency.

### 13.1 ATTACHING SINGLE-FALL HOOK

1. Refer to steps 1 to 7 of [REMOVAL OF WINCH WIRE ROPE] in "10.3 IRREGULAR MAINTENANCE" in the INSPECTION AND MAINTENANCE section and remove the 2-fall/4-fall hook block.
2. Attach the single-fall hook bracket (7) to the end of the boom. Attach the bracket (7) by first removing the four bolts (8) already attached.

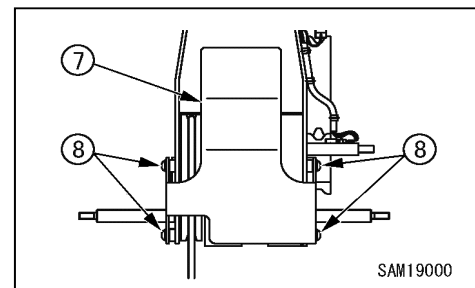

3. Alter the mounting position of the overwinding prevention device (9).

First, detach the harness connector from the device and attach the extension harness (23).

Secure the extension harness (23) in two places using the clips (11).

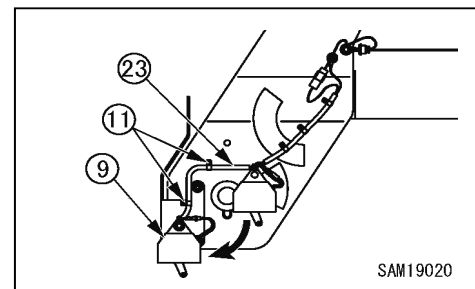

### NOTES

- Reuse the mounting components for the overwinding prevention device (9) as they are.
- Remove the protective wire rope attached to the overwinding prevention device (9); this will be replaced by a dedicated item. Note that the shackle securing the weight on the overwinding prevention device will be reused later.

4. Attach the bar (15) to the rod on the face opposite to the overwinding prevention device (9). Secure the bar sandwiched between two washers (16) using the two nuts (17).

### NOTES

The bar should be clamped not too tightly, but with a small amount of slack to allow it to move smoothly.

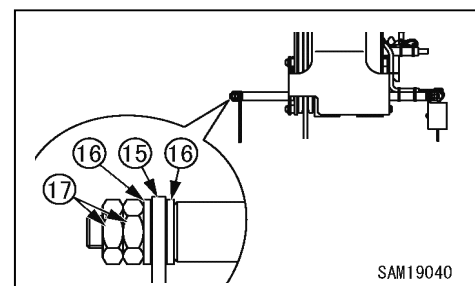



5. Attach protective wire ropes (22) to both the overwinding prevention device (9) and the bar (15). Set the protective wire rope (22) sandwiched between two washers (19) to the bolt (18) inserted into the overwinding prevention device (9) or bar (15), then secure with the nut (20), followed by the U nut (21).

**NOTES**

- Attach the protective wire ropes (22) so that they are positioned on the inside of the overwinding prevention device (9) and bar (15).
- Leave gaps of approximately 2 mm on either side of the protective wire rope (22) between the washers (19) so that it can move smoothly.

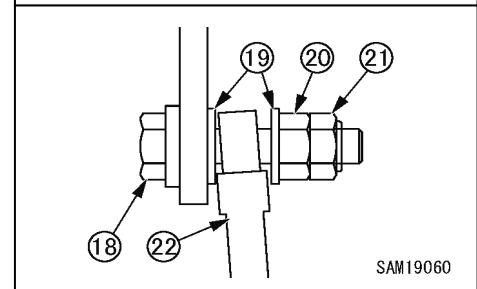
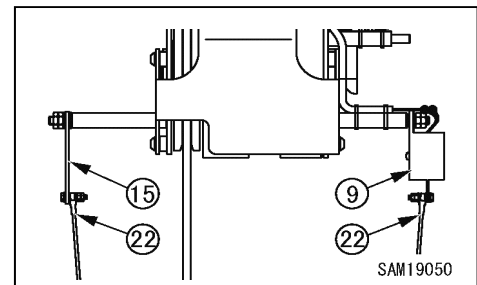

6. Use the shackles (14) to attach the overwinding prevention device weight (13) to the two protective wire ropes (22).

**NOTES**

- Attach the overwinding prevention device weight (13) so that the hole through which the wire rope will be inserted is positioned at (a).
- Reuse one of the shackles (14) from the detached 2-fall/4-fall hook block.

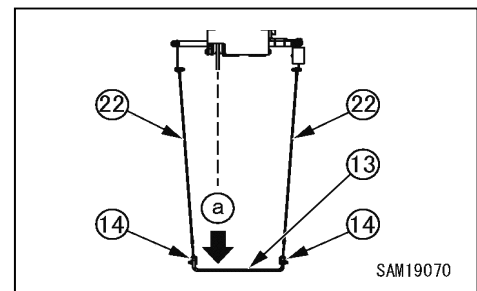

7. Pass the wire rope over the load sheave at the end of the boom as shown in the diagram on the right.

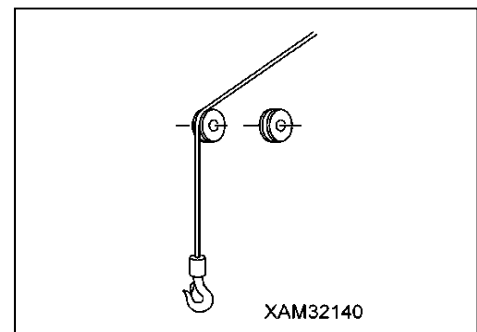

8. Pass the end of the wire rope (12) through the round hole in the overwinding prevention device weight (13).

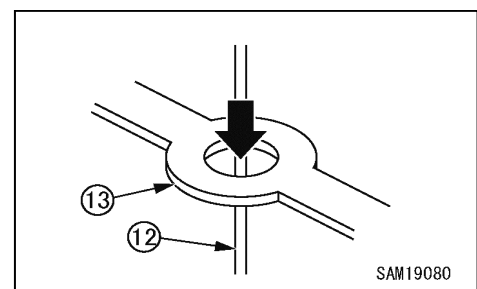



9. Secure the end of the wire rope (12) to the wire socket (37) as follows:

- (1) Draw the wire rope (12) through the wire socket (37) as shown in the diagram on the right.
- (2) Insert the rope wedge (41) at position (a), then firmly pull the wire rope (12) in the direction indicated by the arrow.

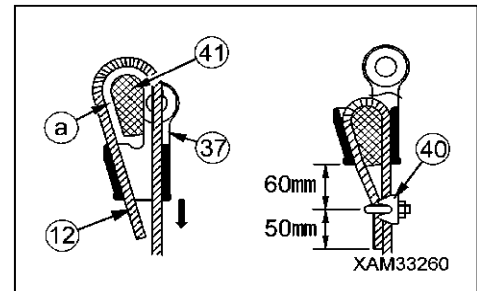

10. Attach a rope clip (4) to the wire rope (5) at the position indicated in the diagram on the right.

11. Insert the wire socket (37) into the connection part (a) inside the hook (10), align with the hole (b) and insert the pin (49), then secure from both sides at positions (c) and (d) using the bolt (50) with the washer (51) inserted.

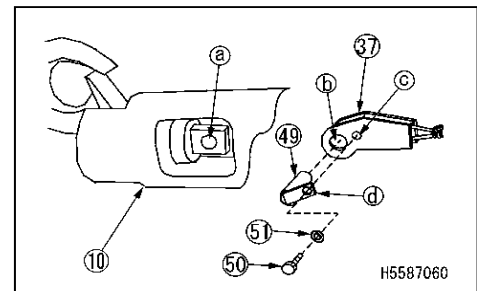

12. Move the operation lever to “RAISE” or “EXTEND” to raise the hook block.

### NOTES

Do not winch until the hook block has been raised; winching before this will result in irregular winding.

### CAUTION

Once the single-fall hook has been attached, wind the hook block up to the highest point and confirm that the overwinding prevention device activates to stop the operation.

## 13.2 DETACHING SINGLE-FALL HOOK

1. Stop the machine on level solid ground, fully retract the boom, and set the boom angle to approximately 20 degrees.
2. Unwind the winch from the state described in step 1 above to unwind the hook block until it is almost touching the ground.
3. Move the operation lever to "LOWER" to lower the hook block to the ground.

### NOTES

Winching to lower the hook block to the ground before the hook block has been raised will result in irregular winding.

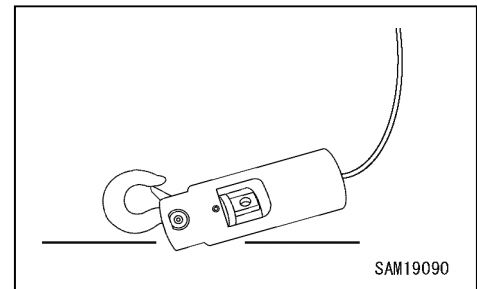

4. Remove the bolt (1) and washer (2) to pull out the pin (3). Remove the wedge socket from the hook block.

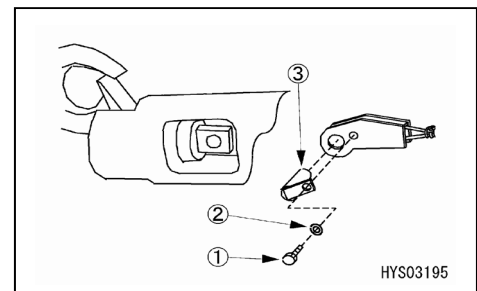

5. Remove the wire rope (5) from the wire socket (3) as follows:

- (1) Press a 6 mm to 10 mm round bar (A) against the rope wedge (6).
- (2) Remove the rope wedge (6) by lightly tapping the round bar (A) with a hammer in the direction indicated by the arrow (a).

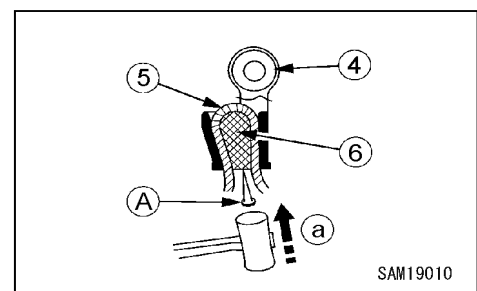

6. Pull out the wire rope (5) from the overwinding prevention device weight.

7. Detach the protective wire ropes (22) from the overwinding prevention device (9) and bar (15).

### NOTES

The overwinding prevention device weight (13) can be left attached to the protective wire ropes (22). Note that the shackles securing the overwinding prevention device weight will be reused later.

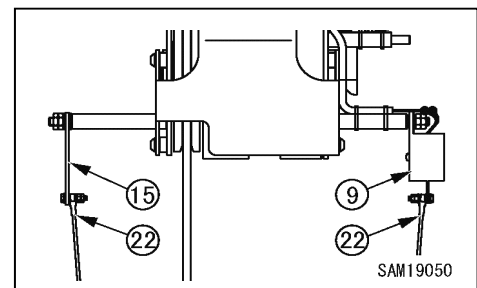

8. Alter the attachment position of the overwinding prevention device (9).

First, detach the connector of the harness from the device, remove the two clips (11) from the extension harness (23), then remove the extension harness (23).

Connect the harness on the vehicle side to the connector on the device.

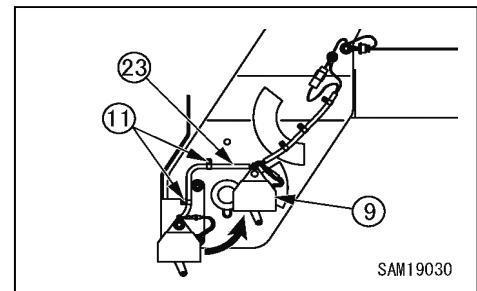

### NOTES

- Reuse the mounting components for the overwinding prevention device (9) as they are.
- The removed extension harness (23) and clips (11) will not be reused.

9. Remove the single-fall hook bracket (7) from the end of the boom. Attach the four bolts (8) at the location of the removed bracket (7).

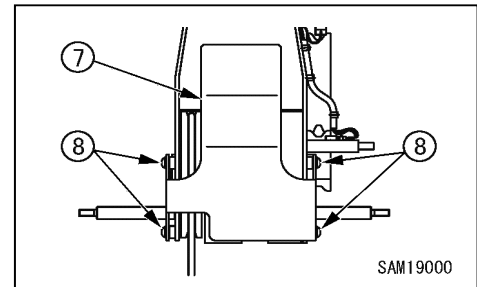

10. Refer to steps 4 to 11 of [INSTALLATION OF WINCH WIRE ROPE] in "10.3 IRREGULAR MAINTENANCE" in the INSPECTION AND MAINTENANCE section and attach the 2-fall/4-fall hook block.

### CAUTION

**Once the 2-fall/4-fall hook has been attached, wind the hook block up to the highest point and confirm that the overwinding prevention device activates to stop the operation.**



This Page Intentionally Left Blank.



# SPECIFICATIONS

1. PRINCIPLE SPECIFICATION LIST	296
2. SPECIFICATION DIMENSIONAL DRAWING	297
3. RATED TOTAL LOAD CHART	298
4. WORKING RADIUS/LIFTING HEIGHT	301



## 1. PRINCIPLE SPECIFICATION LIST

Equipment/Item		CC1485S-1	
Weight and dimensions	Machine mass	14,400kg	
	Overall length x width x height	6,560mm x 2,490mm x 2,865mm	
	Distance between center idler and sprocket	2,880mm	
	Track gauge	1,990mm	
	Width of crawler	500mm	
	Slewing radius at rear end of the machine	1,550mm	
Performance	Maximum rated total load x working radius	6.0t x 2.6m	
	Maximum working radius	16.1m	
	Maximum lifting height above ground	16.7m	
Winch unit	Type	2-speed hydraulic motor with a built-in brake, differential planetary reducing gears, grooved drum	
	Number of falls of wire	4-fall/2-fall hooking wire, single fall (optional)	
	Hook winding speed	Low speed (1)	32.0m/min (Drum layer 4, 4-fall hook)
		High speed (2)	46.0m/min (Drum layer 4, 4-fall hook)
Hoist wire rope		IWRC 6 x Fi (29), $\phi 10 \times 115\text{m}$	
Telescoping system	Type	3 x Sequentially telescoping, double-acting hydraulic cylinder +1 x Wire rope telescoping system	
	Type of boom	Heptagonal cross-section, hydraulically automatic telescoping, 5 stages (Stages 2 and 3: Sequential telescoping; Stages 4 and 5: Simultaneous telescoping)	
	Boom length	4.745m - 7.625m - 10.505m - 13.385m - 16.265m	
	Telescoping stroke / Extending time	11.52m/33 sec	
Boom hoist system	Type	Double-acting hydraulic cylinder direct thrusting system	
	Derricking angle / Time	-4 to 80deg / 19sec	
Slewing system	Type	Fixed capacity, swash plate axial piston motor drive	
	Slewing angle/ speed	360-deg continuous / 1.9rpm	
Travelling system	Type	Variable capacity piston type	
	Travel speed	Low speed (1)	Forward/backward traveling: 0 to 1.9km/h
		High speed (2)	Forward/backward traveling: 0 to 3.2km/h
	Grade ability	20°	
Ground pressure [Shoe width]	49.0kPa (0.50kgf/cm <sup>2</sup> ) [500mm]		
Hydraulic system	Hydraulic pump	Variable capacity piston type	
	Hydraulic oil tank capacity	81 L	
Engine	Model	ISUZU 4LE2XDPC	
	Type	4 stroke-cycle, water-cooled series, direct injection system, with turbocharger	
	Displacement	2.179 L (2,179cc)	
	Rated output	40.3kW/2,000min <sup>-1</sup> (54.8 PS/2,000rpm)	
	Fuel used/fuel tank capacity	Diesel fuel/140 L	
Safety device	Over-hoist preventing device, over-lowering preventing device, slinging rope detachment protector, hydraulic safety valve, telescoping cylinder hydraulic automatic locking device, derricking cylinder hydraulic automatic locking device, alarm buzzer, machine body inclination alarm, working status lamp, leveling instrument (monitor display), and operation locking lever.		
classification	Mobile crane ISO4301/2 Group A1		

## 2. SPECIFICATION DIMENSIONAL DRAWING

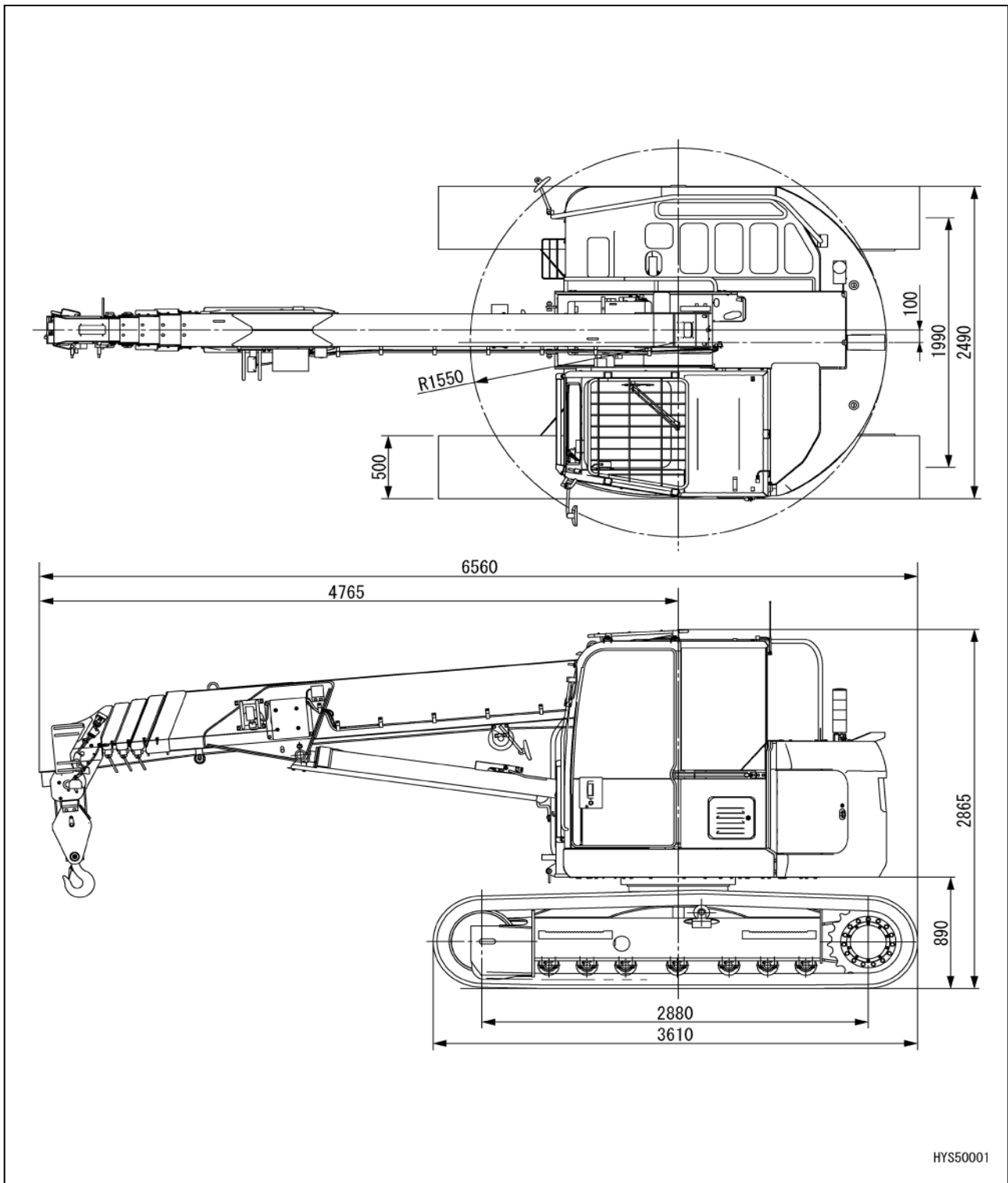



### 3. RATED TOTAL LOAD CHART

#### [1] RATED TOTAL LOAD CHART FOR 4-FALL WIRE ROPE

Unit: kg

Working radius (m)	4.745m Boom		7.625m Boom		10.505m Boom		13.385m Boom	16.265m Boom
	Stationary	Pick & Carry	Stationary	Pick & Carry	Stationary	Pick & Carry	Stationary	Stationary
2.00	6000	2000	6000	2000	3000	1500		
2.50	6000	2000	6000	2000	3000	1500	3000	
2.60	6000	2000	6000	2000	3000	1500	3000	
3.00	5250	2000	5260	2000	3000	1500	3000	2600
3.20	4910	2000	4920	2000	3000	1500	3000	2600
3.50	4450	2000	4460	2000	3000	1500	3000	2600
3.85	4000	2000	4000	2000	3000	1500	3000	2600
4.00	3830	1915	3820	1910	3000	1500	3000	2600
4.50	3320	1660	3310	1655	3000	1500	3000	2600
4.58	3250	1625	3240	1620	3000	1500	2940	2600
4.60			3220	1610	3000	1500	2920	2600
5.00			2880	1440	2710	1355	2640	2600
5.50			2520	1260	2400	1200	2340	2320
6.00			2210	1105	2140	1070	2100	2080
6.50			1950	975	1920	960	1890	1880
7.00			1720	860	1720	860	1710	1710
7.46			1530	765	1570	785	1570	1580
7.50					1550	775	1560	1560
8.00					1400	700	1430	1430
8.50					1270	635	1310	1320
9.00					1150	575	1200	1210
10.00					940	470	1020	1040
10.34					880	440	970	980
11.00							880	890
12.00							750	770
13.00							650	670
13.22							630	650
14.00								580
15.00								500
16.00								440
16.10								430
Boom angle range (deg)	0~64.3		0~74.4		0~78.8		0~80.0	0~80.0

★Hook mass: 90kg

★Boom length:

4.745m boom → Boom retracted minimum

7.625m boom → Boom length more than 4.745m less than 7.625m

10.505m boom → Boom length more than 7.625m less than 10.505m

13.385m boom → Boom length more than 10.505m less than 13.385m

16.265m boom → Boom length 13.385m or more

★The Rated total load Chart is based on the actual working radius including boom deflection.

★The weight of hook block must be included as part of the load shown in the Rated total load Chart.





**[2] RATED TOTAL LOAD CHART FOR 2-FALL WIRE ROPE**

Unit: kg

Working radius (m)	4.745m Boom		7.625m Boom		10.505m Boom		13.385m Boom	16.265m Boom
	Stationary	Pick & Carry	Stationary	Pick & Carry	Stationary	Pick & Carry	Stationary	Stationary
2.00	3000	1000	3000	1000	3000	1000		
2.50	3000	1000	3000	1000	3000	1000	3000	
2.60	3000	1000	3000	1000	3000	1000	3000	
3.00	3000	1000	3000	1000	3000	1000	3000	2600
3.20	3000	1000	3000	1000	3000	1000	3000	2600
3.50	3000	1000	3000	1000	3000	1000	3000	2600
3.85	3000	1000	3000	1000	3000	1000	3000	2600
4.00	3000	1000	3000	1000	3000	1000	3000	2600
4.50	3000	1000	3000	1000	3000	1000	3000	2600
4.58	3000	1000	3000	1000	3000	1000	2940	2600
4.60			3000	1000	3000	1000	2920	2600
5.00			2880	1000	2710	1000	2640	2600
5.50			2520	1000	2400	1000	2340	2320
6.00			2210	1000	2140	1000	2100	2080
6.50			1950	975	1920	960	1890	1880
7.00			1720	860	1720	860	1710	1710
7.46			1530	765	1570	785	1570	1580
7.50					1550	775	1560	1560
8.00					1400	700	1430	1430
8.50					1270	635	1310	1320
9.00					1150	575	1200	1210
10.00					940	470	1020	1040
10.34					880	440	970	980
11.00							880	890
12.00							750	770
13.00							650	670
13.22							630	650
14.00								580
15.00								500
16.00								440
16.10								430
Boom angle range (deg)	0~64.3		0~74.4		0~78.8		0~80.0	0~80.0

★Hook mass: 90kg

★Boom length:

4.745m boom → Boom retracted minimum

7.625m boom → Boom length more than 4.745m less than 7.625m

10.505m boom → Boom length more than 7.625m less than 10.505m

13.385m boom → Boom length more than 10.505m less than 13.385m

16.265m boom → Boom length 13.385m or more

★The Rated total load Chart is based on the actual working radius including boom deflection.

★The weight of hook block must be included as part of the load shown in the Rated total load Chart.



**[3] RATED TOTAL LOAD CHART FOR SINGLE-FALL WIRE ROPE**

Unit: kg

Working radius (m)	4.745m Boom		7.625m Boom		10.505m Boom		13.385m Boom	16.265m Boom
	Stationary	Pick & Carry	Stationary	Pick & Carry	Stationary	Pick & Carry	Stationary	Stationary
2.00	1500	500	1500	500	1500	500		
2.50	1500	500	1500	500	1500	500	1500	
2.60	1500	500	1500	500	1500	500	1500	
3.00	1500	500	1500	500	1500	500	1500	1500
3.20	1500	500	1500	500	1500	500	1500	1500
3.50	1500	500	1500	500	1500	500	1500	1500
3.85	1500	500	1500	500	1500	500	1500	1500
4.00	1500	500	1500	500	1500	500	1500	1500
4.50	1500	500	1500	500	1500	500	1500	1500
4.60	1500	500	1500	500	1500	500	1500	1500
4.68	1500	500	1500	500	1500	500	1500	1500
5.00			1500	500	1500	500	1500	1500
5.50			1500	500	1500	500	1500	1500
6.00			1500	500	1500	500	1500	1500
6.50			1500	500	1500	500	1500	1500
7.00			1500	500	1500	500	1500	1500
7.50			1500	500	1500	500	1500	1500
7.56			1500	500	1500	500	1500	1500
8.00					1400	500	1430	1430
8.50					1270	500	1310	1320
9.00					1150	500	1200	1210
10.00					940	470	1020	1040
10.44					860	430	950	970
11.00							880	890
12.00							750	770
13.00							650	670
13.32							620	640
14.00								580
15.00								500
16.00								440
16.20								420
Boom angle range (deg)	0~64.3		0~74.4		0~78.8		0~80.0	0~80.0

★Hook mass: 20kg

★Boom length:

4.745m boom → Boom retracted minimum

7.625m boom → Boom length more than 4.745m less than 7.625m

10.505m boom → Boom length more than 7.625m less than 10.505m

13.385m boom → Boom length more than 10.505m less than 13.385m

16.265m boom → Boom length 13.385m or more

★The Rated total load Chart is based on the actual working radius including boom deflection.

★The weight of hook block must be included as part of the load shown in the Rated total load Chart.

## 4. WORKING RADIUS/LIFTING HEIGHT

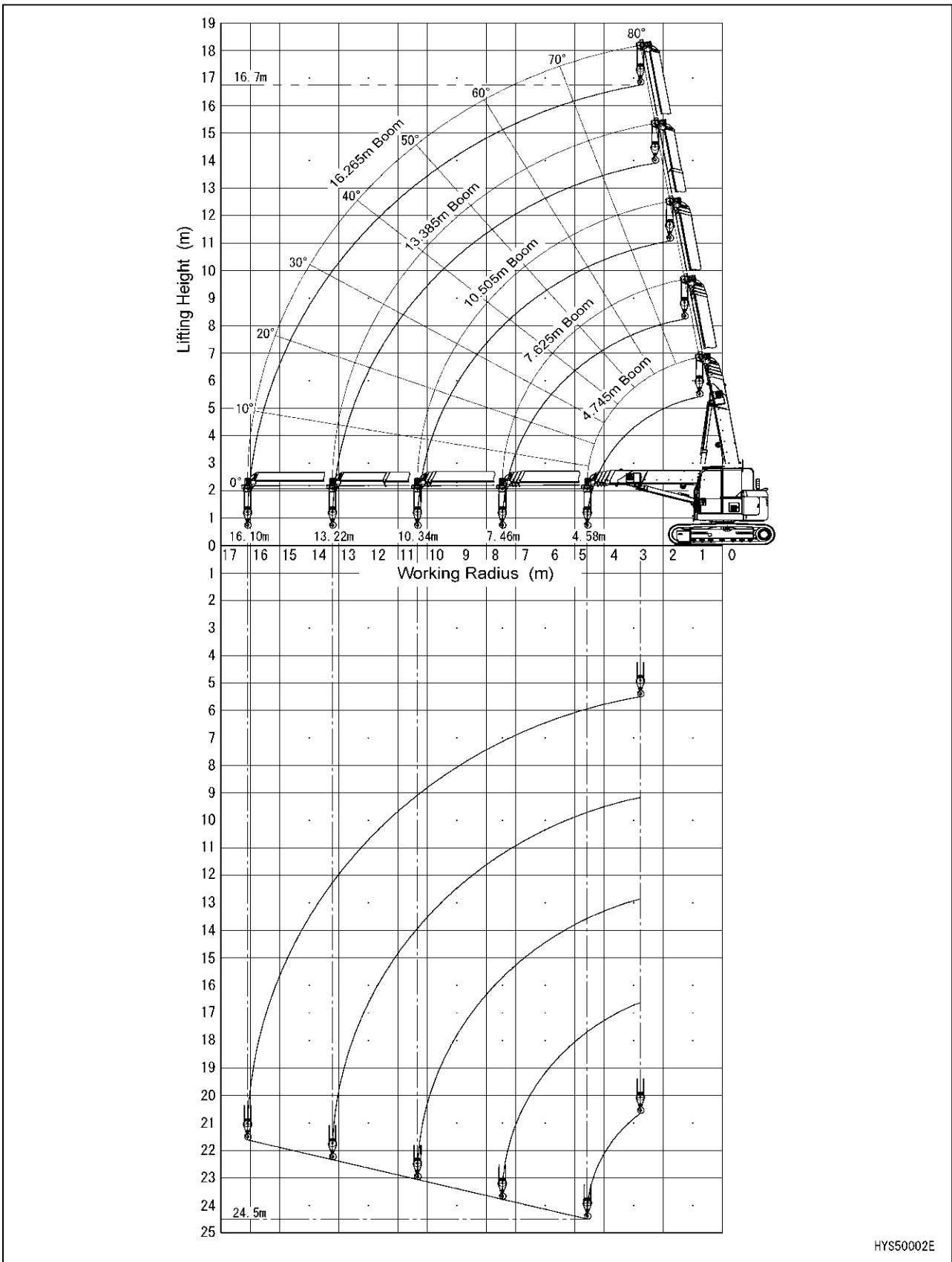

HYS50002E



**This Page Intentionally Left Blank.**



# FLY-JIB

Item	Page
1. PRECAUTIONS OF FLY-JIB OPERATION	304
2. SAFETY LABEL LOCATION	306
3. FLY-JIB EACH SECTION	309
4. FLY-JIB INSTALLATION AND STOWAGE	310
5. HANDLING MONITOR AND MOMENT LIMITER	342
6. OPERATIONS	348
7. TROUBLESHOOTING	349
8. INSPECTION AND MAINTENANCE	351
9. SPECIFICATIONS	354



## 1. PRECAUTIONS OF FLY-JIB OPERATION

### **⚠ WARNING**

- The Fly-jib is installed to the Main boom with four position pins. The Fly-jib tilt angle is adjusted by extending or retracting of the angle adjuster rod, then the Fly-jib is fixed to the angle by one position pin. The Fly-jib consists of two sections and another position pin fixes the 1st and 2nd section. Prior to starting operation, always ensure these three position pins are inserted in the correct positions and secured by the linchpins. If the linchpins are not secure, the pins may drop out and the Fly-jib will collapse which may cause a serious hazard.
- Whenever the Fly-jib is installed, it is essential to re-connect the over-hoist detector harness from the Main boom detector to the Fly-jib detector. Also, always ensure the over-hoist detector of the Fly-jib is working correctly before starting operation. In the event that the over-hoist detector mis-functions, it may cause the hook or hoisted load to drop and result in a serious hazard.
- Whenever the Fly-jib is installed, ensure that the number of the Fly-jib sections used and the indication in the moment limiter for the Fly-jib are identical, before starting the Fly-jib operations. Otherwise, it may cause serious accidents such as damage to the Fly-jib or the machine tipping resulting in death or serious injury.
- Whenever the Fly-jib is installed, always keep the engine speed in low idling so that the machine is operated in low speed. Sudden lever operation may produce excessive load to the Fly-jib which may cause damage to the Fly-jib resulting in a serious accident.
- When the Fly-jib is installed, any error in crane operations may deform brackets or crack welded joints which may result in collapsing of the Fly-jib. Prior to starting operations, always check each area of the Fly-jib to ensure it has no deformation or cracked welded joints.
- The Fly-jib is stowed to the side of the Main boom and fixed to it with three position pins. When installing or stowing the fly-jib, always ensure all three position pins are inserted in the correct position and secured by their linchpins. Otherwise, if any of the pins drop out, the Fly-jib will detach from the main boom and fall off, which may cause a serious hazard.
- When the Fly-jib is stowed, always re-connect the over-hoist detector harness from the Fly-jib detector to the Main boom detector. Always ensure the over-hoist detector of the Main boom is working correctly before starting operation. In the event that the over-hoist detector mis-functions, it may cause the hook or hoisted load to drop and result in a serious hazard.
- This section of the manual applies only to a machine with the Fly-jib installed to the Main boom. If the Fly-jib is removed from the Main boom, the Moment limiter must be reset accordingly. Contact our sales partner in every such event. If the moment limiter is not reset correctly, operation of the machine may result in a serious hazard such as machine damage or tipping over.
- For all other safety precautions not covered in this section, refer to the section “SAFETY”.



## CAUTION

- The machine weight depends on the machine configuration.  
The weight table on the right shows the weight of the standard vehicle and additional weight of respective accessory units.

CC1485S-1	
MACHINE WEIGHT	
Spec	Weight
Main Unit	14400kg
Fly Jib	+300kg
Rubber Pads	+470kg
<small>585-4738900</small>	

- The Fly-jib tilt angle is adjustable to four (4) positions (0, 20, 40 and 60 degrees).  
During the Fly-jib operations, always keep the boom angle in the range as specified below:  
[At the Fly-jib angle in 0 or 20 degrees]  
Perform the crane operation within the boom angle range of “45 degrees” or more. When a load is hoisted in a condition that the boom angle is less than “45 degrees” and the boom length is “5.3 m” or longer, the moment limiter emits a warning signal, the buzzer sounds intermittently, and hook hoisting, boom telescoping and boom lowering operations automatically stop.  
However, when the boom length is less than “5.3 m”, the moment limiter does not emit a warning signal. In a condition where the boom angle is less than “45 degrees”, boom lowering operation is not available unless the boom length is less than “5.3 m”.  
[At the Fly-jib angle in 40 or 60 degrees]  
Perform the crane operation within the boom angle range of “65 degrees” or more. When a load is hoisted in a condition that the boom angle is less than “65 degrees” and the boom length is “5.3 m” or longer, the moment limiter emits a warning signal, the buzzer sounds intermittently, and hook hoisting, boom telescoping and boom lowering operations automatically stop.  
However, when the boom length is less than “5.3 m”, the moment limiter does not emit a warning signal. In a condition where the boom angle is less than “65 degrees”, boom lowering operation is not available unless the boom length is less than “5.3 m”.

## 2. SAFETY LABEL LOCATION

### CAUTION

In this section, the safety labels indicated are exclusive for The Fly-jib model but different from those of a standard model. For labels other than these, refer to the section: "Safety 5. Safety Label Location".

Keep these safety labels clean and legible at all times.

When a safety label is degraded, missing or illegible, replace with a new label.

In addition to the safety labels shown below, some other labels are required to be used. Control them in the same manner.

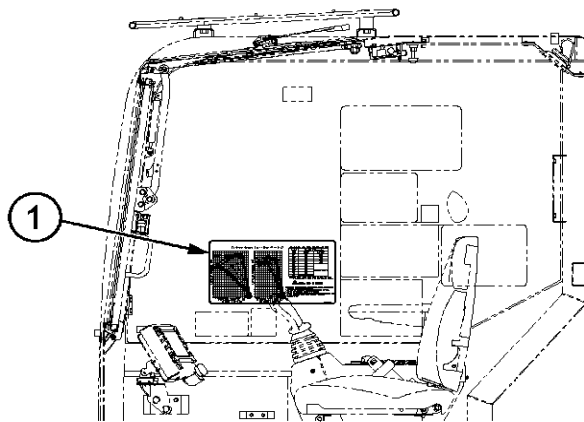

Right Side Glass in Cab

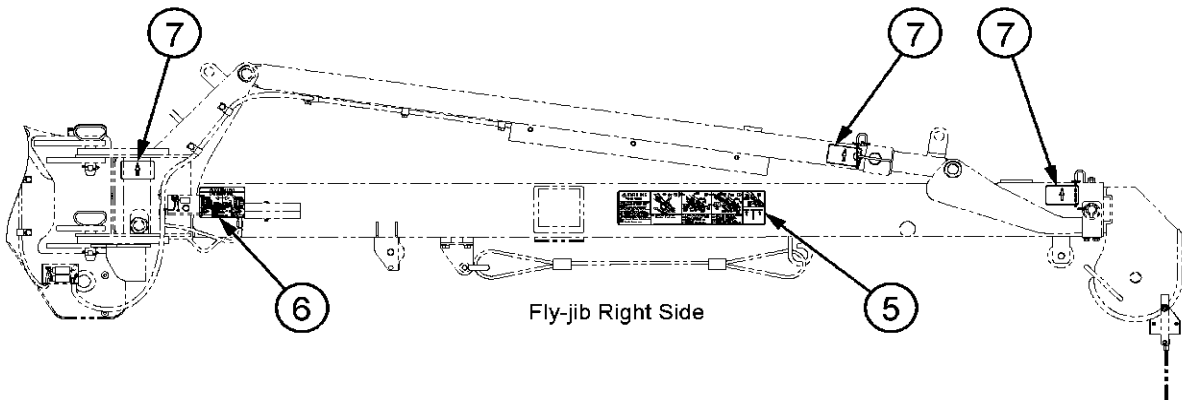

Fly-jib Right Side

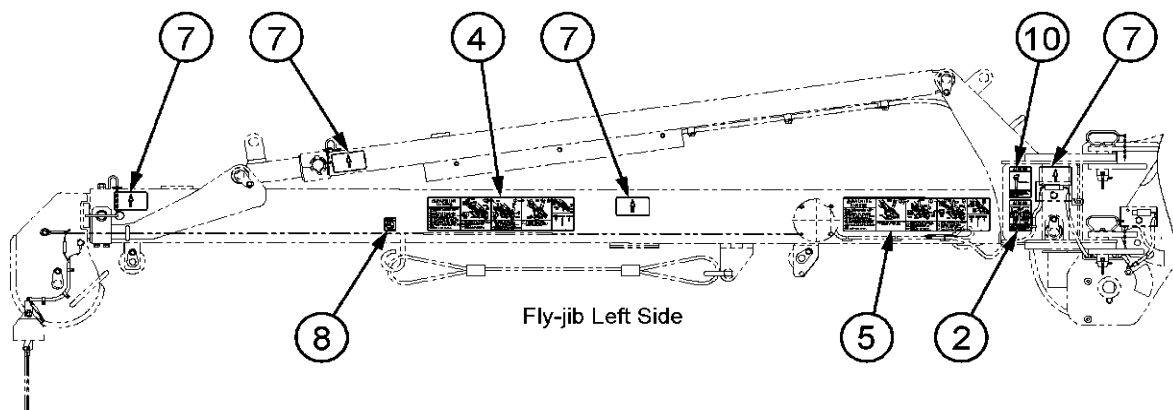

Fly-jib Left Side

SAM15800E





(1) Work range chart for fly-jib (585-2237900)

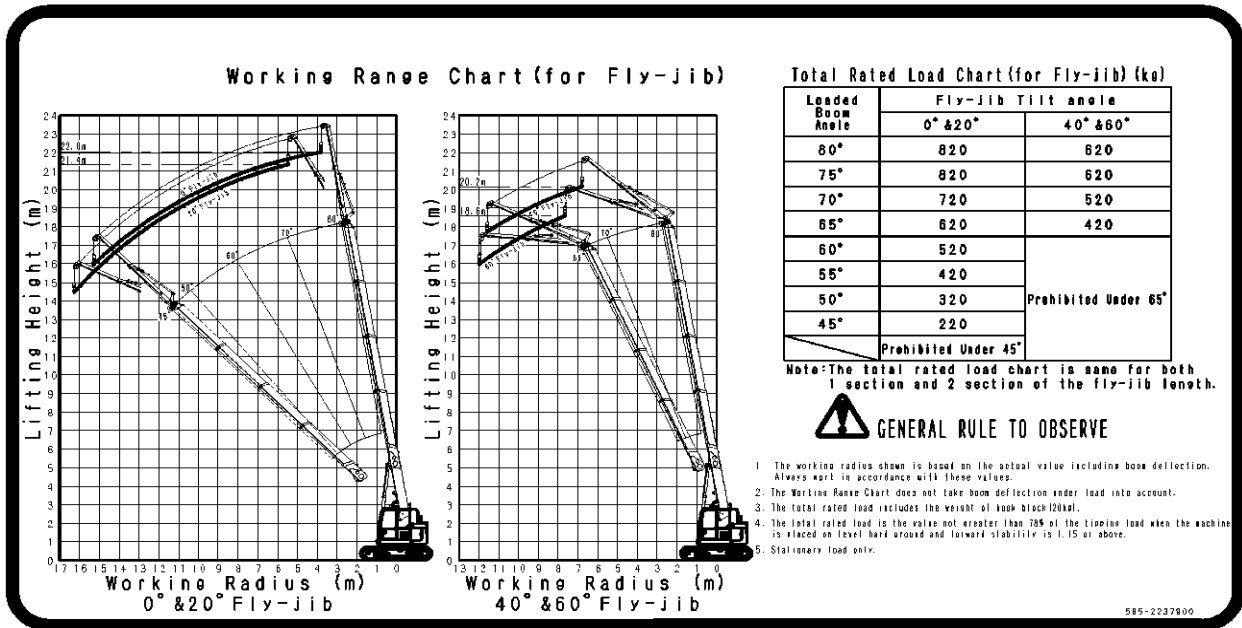

(2) Over-hoist detection wiring instruction (585-3558600)

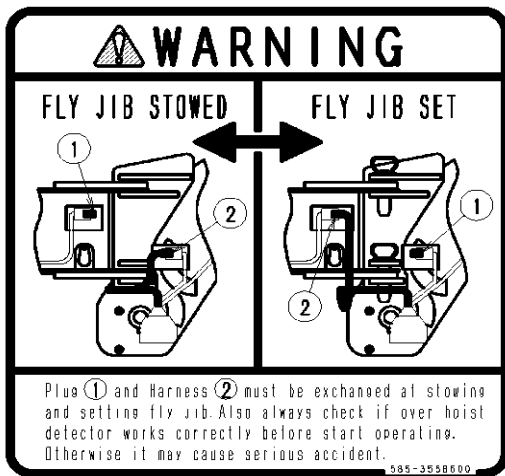

(4) Warning for fly-jib installation (585-2238200)

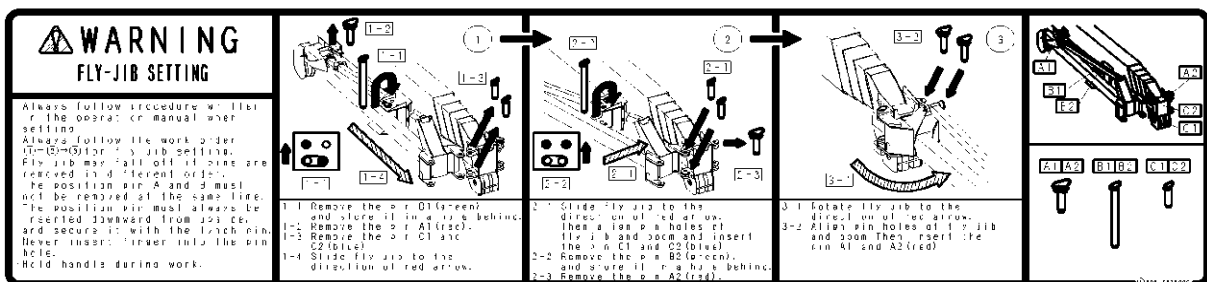



(5) Warning for fly-jib stowage (585-2238300) (2 places)

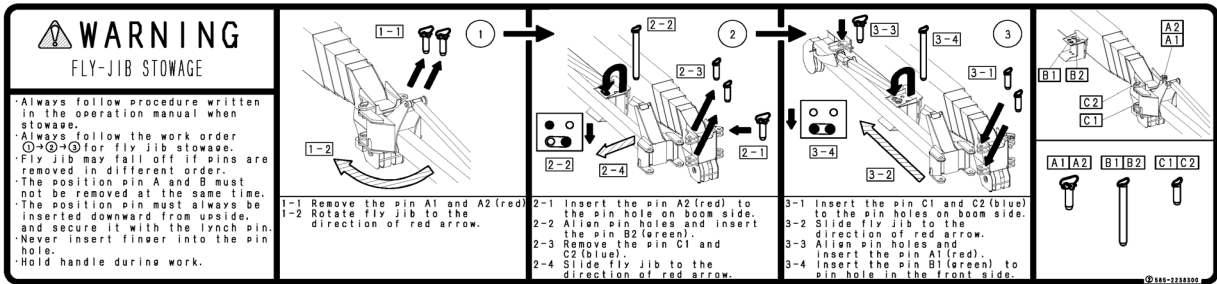

(6) Fly-jib detection wiring instruction (585-3558100)

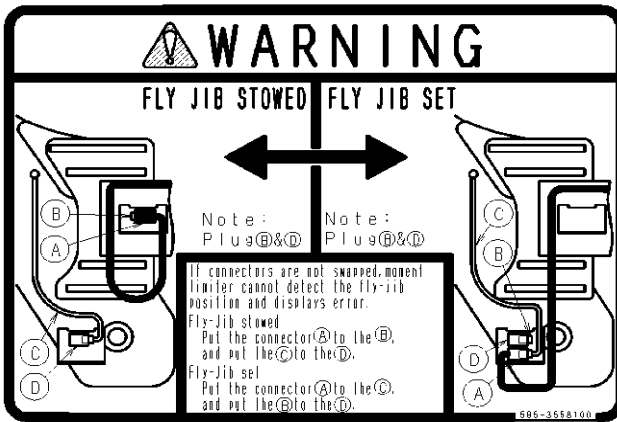

(7) Pin hole caution (349-4426900) (7 places)



(8) Caution for hole (556-4580700)



(10) Explanation of split pin (585-3558700)



### 3. FLY-JIB EACH SECTION

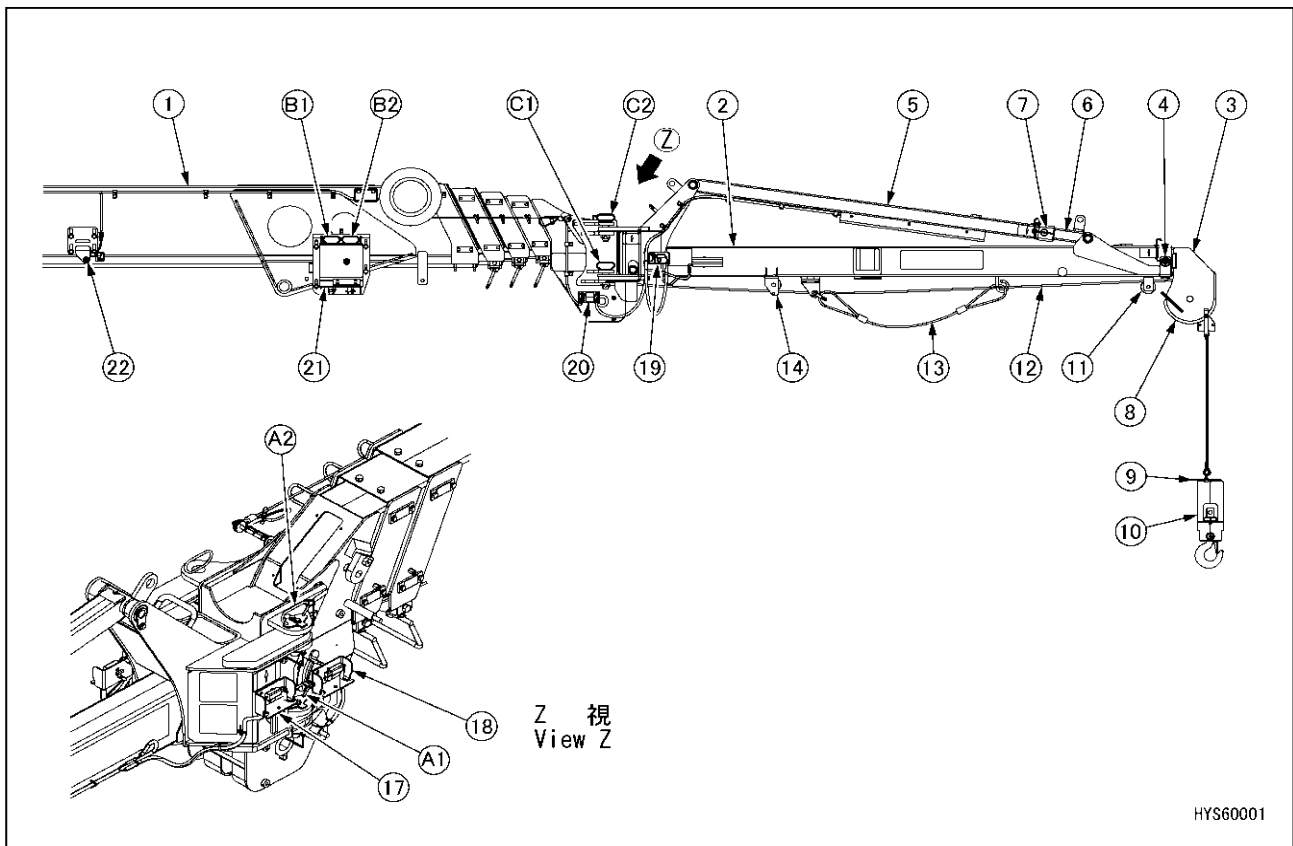

HYS60001

- |   |   |
|---|---|
| (1) Main boom   | (18) Harness connection part<br>(For over hoist detection) (Main boom side) |
| (2) No.1 Fly-jib  | (19) Harness connection part<br>(For fly-jib detection) (Fly-jib side)      |
| (3) No.2 Fly-jib  | (20) Harness connection part<br>(For fly-jib detection) (Main boom side)    |
| (4) Position pin  | (21) Fly-jib bracket A  |
| (5) Outer rod (For fly-jib angle adjusting)                               | (22) Fly-jib bracket B  |
| (6) Inner rod (For fly-jib angle adjusting)                               | (A1) Position pin A1  |
| (7) Position pin  | (A2) Position pin A2  |
| (8) Sheave  | (B1) Position pin B1  |
| (9) Weight  | (B2) Position pin B2  |
| (10) Hook   | (C1) Position pin C1  |
| (11) Sheave   | (C2) Position pin C2  |
| (12) Wire rope  |   |
| (13) Hook stowing wire  |   |
| (14) Sheave   |   |
| (17) Harness connection part<br>(For over hoist detection) (Fly-jib side) |   |

## 4. FLY-JIB INSTALLATION AND STOWAGE

### ⚠ WARNING

- It is recommended that two operators perform the installation and stowage work of the Fly-jib. Prior to operation, discuss each person's duties in detail and follow the agreed signals during the operation. If signals are not clearly understood, it may cause an accident resulting in injury or death.
- Fly-jib installation and stowage must be practiced on solid level ground. Otherwise, the Fly-jib may turn under its own weight and cause a serious hazard.
- Fly-jib installation and stowage require a rigid stepping stool of sufficient height. An unstable stool may result in the user falling from a height and may incur serious personal harm.
- For Fly-jib installation and stowage, it is essential to keep the main boom angle level. Otherwise, when the boom is not kept level, the weight of the Fly-jib itself will make it turn which may result a serious accident.
- The Fly-jib is installed to the Main boom with four position pins. The Fly-jib consists of two sections and another position pin fixes the 1st and 2nd sections. Prior to starting operation, always ensure these three position pins are inserted in the correct positions and secured by their linchpins. Otherwise, if any of the pins drops out, the Fly-jib will drop which may cause a serious hazard.
- The Fly-jib tilt angle is adjustable from the stowage position to four (4) positions (0, 20, 40 and 60 degrees), and one position pin is used to fix it. When the Fly-jib angle is adjusted to the intended tilt angle, insert the position pin to the correct location and secure it firmly with its linchpin. Otherwise, when the position pin drops out, the Fly-jib will collapse, which may result a serious accident.
- Whenever the Fly-jib is installed, it is essential to re-connect the over-hoist detector harness from the Main boom detector to the Fly-jib detector. Always ensure the over-hoist detector of the Fly-jib is working correctly before starting operation. In the event that the over-hoist detector mis-functions, it may cause the hook or hoisted load to drop and result in a serious hazard.
- Whenever the Fly-jib is installed, it is essential to re-connect the Fly-jib detector harness from the connector in the Fly-jib to the one in the Main boom. In the event that the moment limiter fails its correct functions, that may cause the hook or hoisted load to drop resulting in death or serious injury.
- The Fly-jib is stowed to the side of the Main boom and fixed to it with four position pins. When installing or stowing the fly-jib, always ensure all four position pins are inserted in the correct position and secured by their linchpins. Otherwise, if any of the pins drop out, the Fly-jib will become detached from the main boom and fall off, which may cause a serious hazard.
- When the Fly-jib is stowed, always re-connect the over-hoist detector harness from the Fly-jib detector to the Main boom detector. Always ensure the over-hoist detector of the Main boom is working correctly before starting operations. Should the over-hoist detector mis-functions, it may cause the hook or hoisted load to drop resulting in a serious hazard.
- Whenever the Fly-jib is stowed, it is essential to re-connect the Fly-jib detector harness from the connector in the Main boom to the one in the Fly-jib. In the event that the moment limiter fails its correct functions, that may cause the hook or hoisted load to drop resulting in death or serious injury.

### CAUTION

The lever block (23) included in the accessories shall be set to the bracket between the tilt angle adjuster outer rod and inner rod, for the purpose of changing the Fly-jib tilt angle. For the use of the lever block, refer to the attached manual.

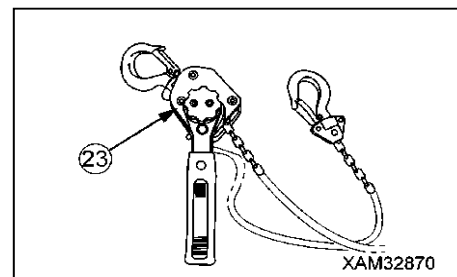

## 4.1 INSTALLATION OF FLY-JIB

Practice installing the Fly-jib to the Main boom from the stowed position from the right side as shown below:

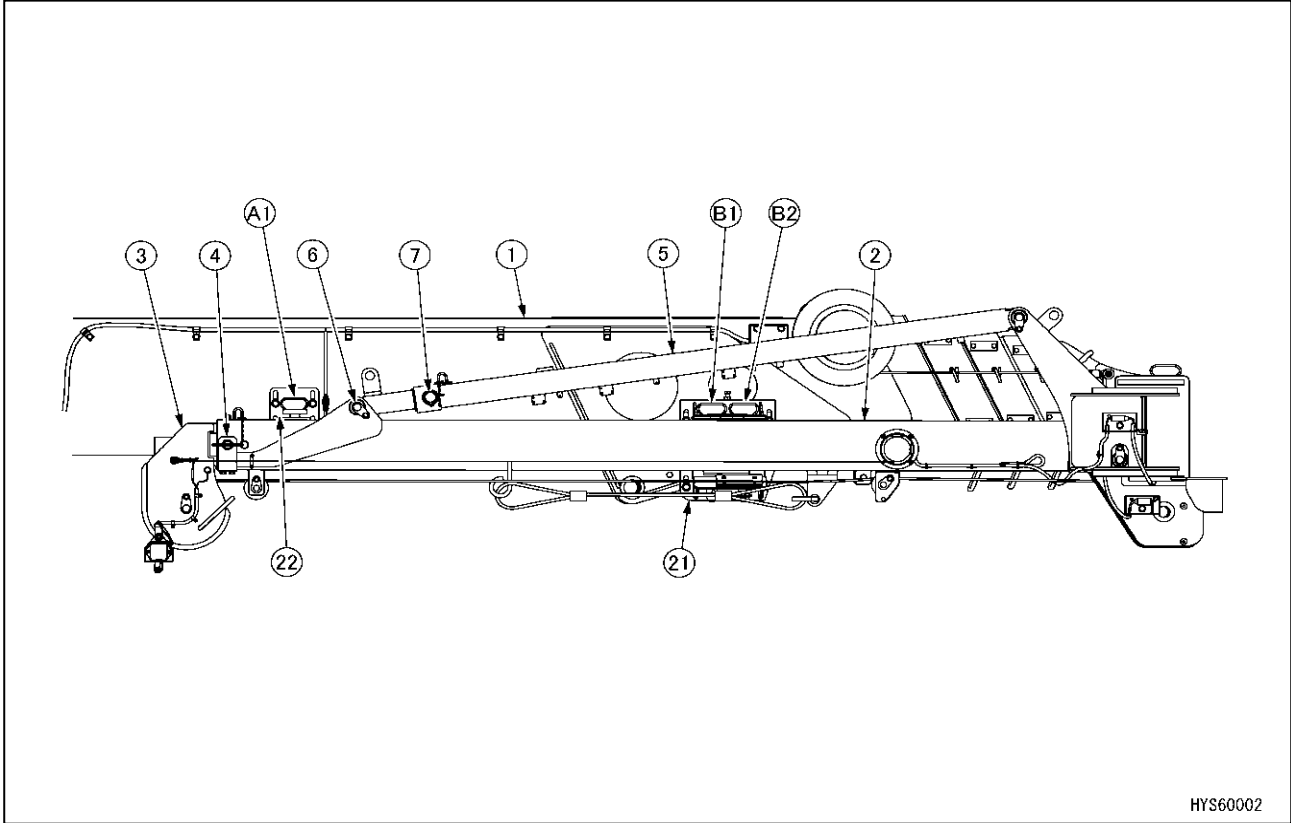

HYS60002

### **⚠ WARNING**

**Always avoid standing on crawlers for installation work. You may miss your footing and fall resulting in serious injury. For elevated work, always prepare a strongly-built work platform.**

1. Pull the linchpin of the position pin (B1) of the stowage bracket A (21) and pull out the position pin (B1). Insert the pulled out position pin (B1) into the hole for pin storage at the back of the stowage bracket A (21). Securely lock with the linchpin after insertion.

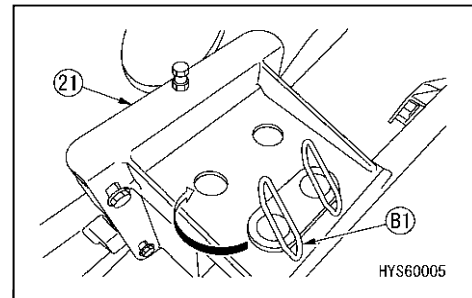

2. Pull the linchpin out from the position pin (A1) in the Fly-jib bracket B (22) to pull out the position pin (A1).

**NOTES**

The removed position pin (A1) will be required for the later operation of installing the Fly-jib to the lower part on the left of the Main boom tip.

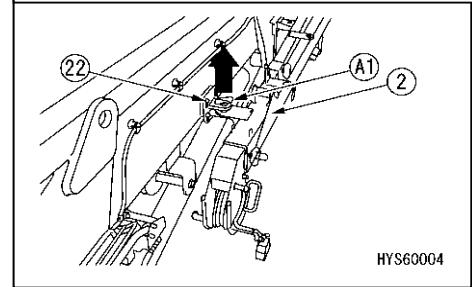

3. Pull out the position pins (C1, C2) from the bracket (26) on the right side of the main boom tip.

**NOTES**

- The removed position pins (C1, C2) will be required for the later operation of installing the Fly-jib to the lower part on the right of the Main boom tip.

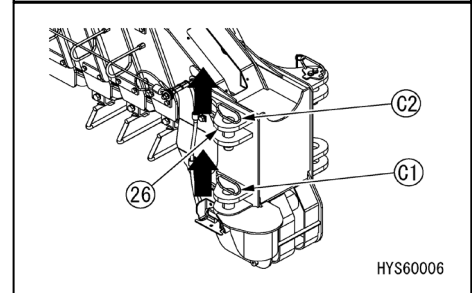

4. Holding the handle (H4) of the No. 1 Fly-jib (2) with the position pin (B2) of the stowage bracket A (21) as a fulcrum, pull it out to the Main boom tip side and align the bracket (26) holes (A, B) on the right side of the Main boom tip with the hole positions of the No. 1 Fly-jib (2) connection.

**CAUTION**

When pulling out the No. 1 Fly-jib (2), hold the handle (H4) instead of the pin holes to perform work.

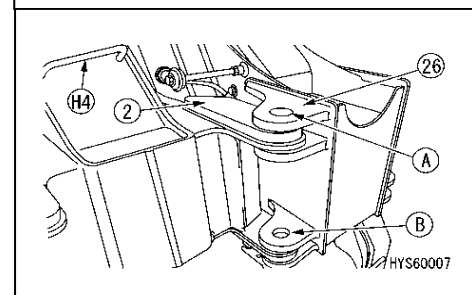
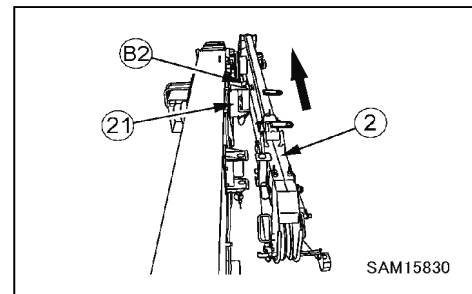



- Once the connection hole of the No.1 Fly-jib (2) and the holes (A, B) of the bracket (26) on the right side of the Main boom tip are aligned, insert the position pins (C1, C2) to the hole then secure it with the linchpin.

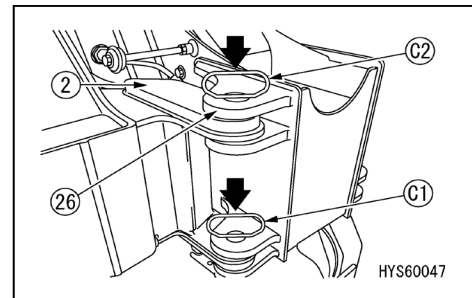

**⚠ WARNING**

- Do not remove the position pin (B2) from the fly-jib bracket A (21) until the position pin (C1, C2) is fully inserted into the hole of the bracket (21). Incorrect fitting order may cause a serious hazard.
- The position pins (C1, C2) must always be inserted downward from upper side. If it is inserted from the underside it could drop out allowing the Fly-jib to collapse causing a serious hazard.

**CAUTION**

When the position pins (B2, C1, C2) are fitted into both holes of the bracket (26) on the right side of the Main boom tip and Fly-jib bracket A (21), Main boom telescoping must not be operated. This operation will critically damage the Fly-jib and Main boom.

- Pull the linchpin out from the position pin (B2) in the Fly-jib bracket A (21) to pull out the position pin (B2).

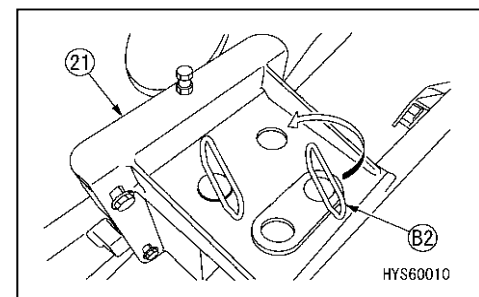

- Pull the linchpin of the position pin (A2) of the bracket (27) on the left side of the main boom tip and pull out the position pin (A2).

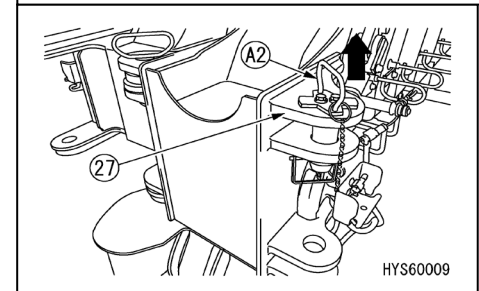

**NOTES**

- The removed position pin (A2) will be required for the later operation of installing the Fly-jib to the lower part on the left of the Main boom tip.

- Slide the No.1 Fly-jib (2) forward through the position pins (C1, C2) on the right side of the Main boom tip as a point of support, and then turn it toward to the front of the Main boom.

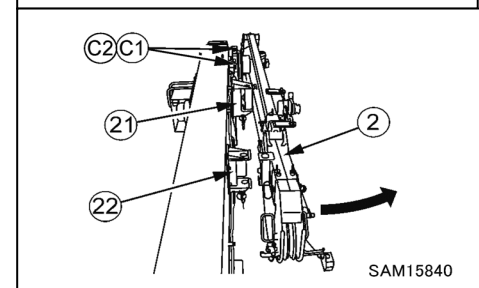



9. Fit the connection hole of the No.1 Fly-jib (2) to the hole (C, D) of bracket (27) on the left side of the Main boom tip.

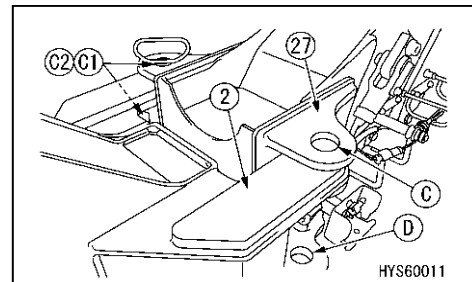

10. Once the connection hole of the No.1 Fly-jib (2) and the hole (C, D) of the bracket (27) on the left side of the Main boom tip are adjusted, insert the position pins (A1, A2) to the hole then secure it with the linchpin.

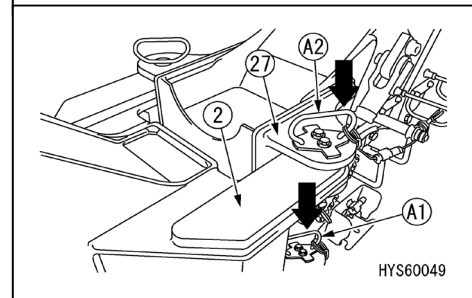

**NOTES**

If it is difficult to insert the position pins (A1, A2), lift and shake the Fly-jib tip.

**⚠ WARNING**

The position pins (A1, A2) must always be inserted downward from the upper side. Otherwise, if it is inserted upward from the underside, the position pin could easily drop down to cause the Fly-jib to collapse causing a serious hazard.

11. Swap the harness connection part (17) and (18) as shown below to switch and connect over-hoist detector.

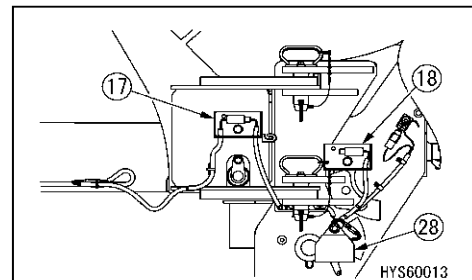

(1) Disconnect the dummy plug (30) connected to the connector (29) of the harness connection (17) on the Fly-jib side.

Before harness exchange;  
the Fly-jib side:

**NOTES**

Removed dummy plug (30) will be later inserted into a connector in the harness connection part (18: Main boom side).

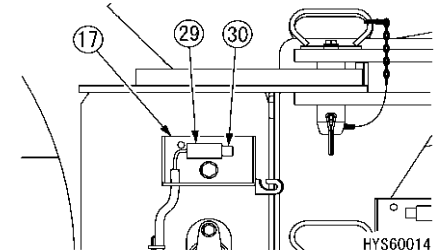

(2) Disconnect the wiring connector (32) connected to the connector (31) of the harness connection (18) on the main boom side.

Before harness exchange;  
the Main boom side:

**NOTES**

Removed harness plug (32) will later be connected into a connector of the harness connection part (17: Fly-jib side).

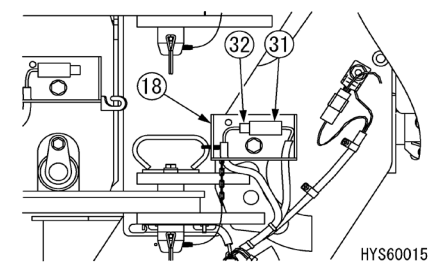



- (3) Connect the dummy plug (30) disconnected in Section (1) to the connector (31).

**CAUTION**

Don't forget to install the dummy plug (30) into the connector (31) in the harness connection part (18: Main boom side). If you do not, the absence of the dummy plug may cause mis-function of the over-hoist detector. In such event, it may cause the hook or hoisted load to drop and result in a serious hazard.

- (4) Connect the wiring connector (32) disconnected in Section (2) to the connector (29) of the harness connection (17) on the Fly-jib side.

After harness exchange;  
the Main boom side:

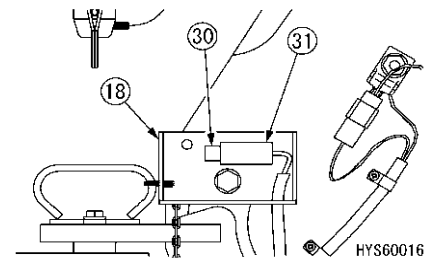

After harness exchange;  
the Fly-jib side:

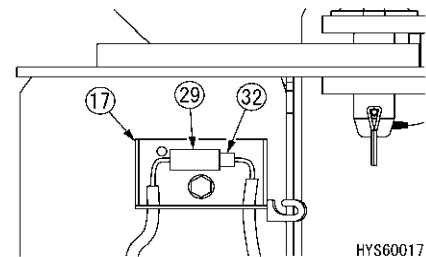

12. Swap the harness connection part (19) and (20) as shown below to switch and connect fly-jib angle and length detector.

- (1) Disconnect the wiring connector (34), including the clip, connected to the connector for stowage (33) of the harness connection (19) on the Fly-jib side.

**NOTES**

Removed storage connector (33) and harness connector (34) will later be connected into a connector in the harness connection part (20: Main boom side).

- (2) Disconnect the wiring connector (36) connected to the connector for stowage (35) of the harness connection (20) on the main boom side.

**NOTES**

Removed harness connector (36) will later be connected into a connector in the harness connection part (19: Fly-jib side).

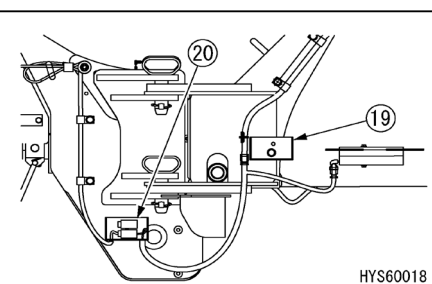

Before harness exchange;  
the Fly-jib side:

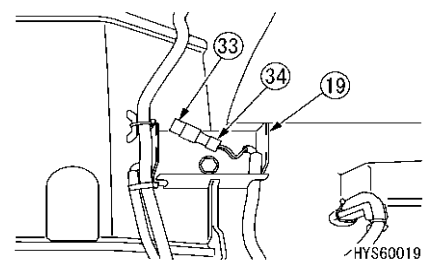

Before harness exchange;  
the Main boom side:

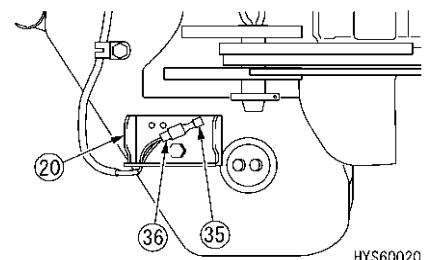

- (3) Connect the wiring connector (34) disconnected in Section (1) to the wiring connector (36). In the same way, connect the connector for stowage (33) disconnected in Section (1) to the connector for stowage (35).

### NOTES

Arrange the harness connector (34) to pass through the notch hole under the harness connection part (20: Main boom side) after removing it from harness connection part (Fly-jib side).

After harness exchange;  
the Main boom side:

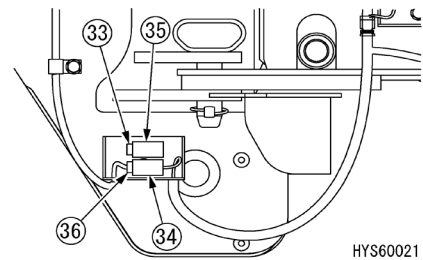

13. Remove the wire rope from the hook block as shown below:

### CAUTION

- Take care to avoid the wire rope winding randomly.
- Avoid unwinding after the hook is grounded; that could make the wire rope wind randomly around the winch drum.

- (1) Retract the boom fully and set the boom angle to approx. 20 degrees.
- (2) Lower the hook so that it almost touches the ground.
- (3) Lower the boom to allow the hook to ground.
- (4) Remove bolt (39) and extract a wedge socket pin (38), then remove the wire socket (37) from the Main boom.
- (5) Remove the wire clip (40).

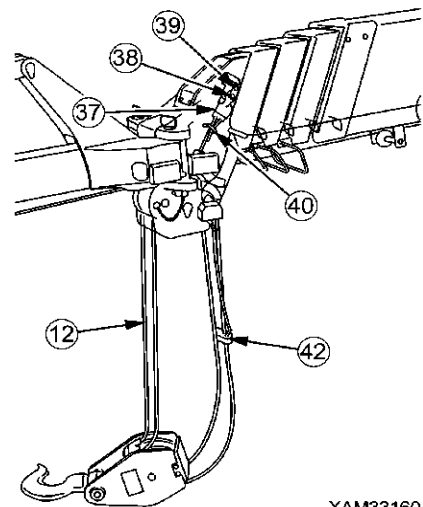

- (6) Using a bar (A) with a diameter of 6 to 8 mm and apply to the rope wedge (41) and hammer it lightly; so that the rope wedge (41) is removed.
- (7) Remove the wire rope (12) from the hook.
- (8) Remove the wire rope (12) from the over-hoist detector weight (42).
- (9) Pull out the wire rope (12) to a sheave in the Main boom tip.
- (10) Hook the over-hoist detector weight (42) to the weight hanger (43) below the main boom.

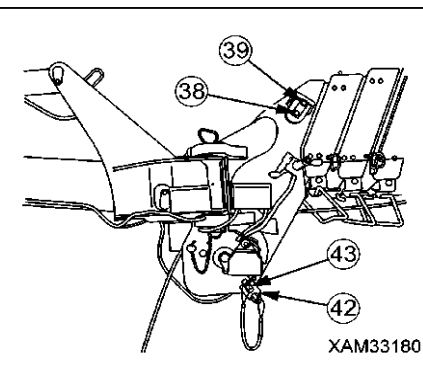
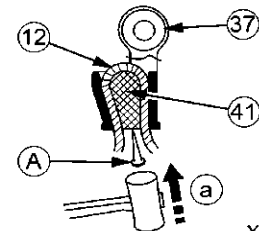



14. Start the engine and wind up the removed wire rope (12) in accordance with 13, above by winch operation.

**CAUTION**

- Take care to avoid the wire rope winding randomly.
- The wire rope should not be wound to the end, so stop winding to allowing 7 m to 8 m excess from sheave (44) of the boom tip.

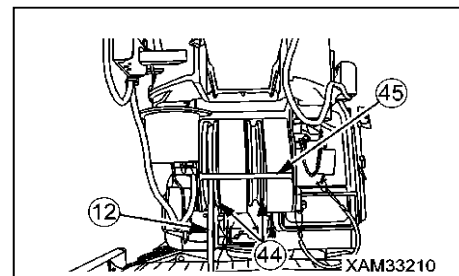

15. Stop the engine then take the wire rope (12) off from the wire rope holder (45) at the boom tip. Arrange the wire rope to go straight through the sheave of the main boom tip to the Fly-jib.

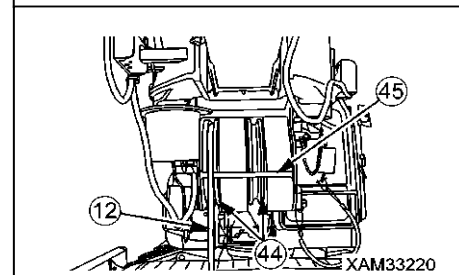

16. Detach the over-hoist detector weight (9) from the weight hanger (46) on the right side of the Fly-jib (2).

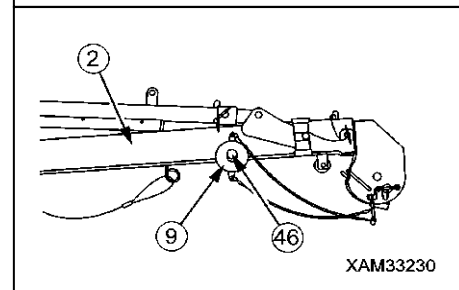

17. Arrange the wire rope (12) to pass below the sheave (14) and over the sheave (11) and sheave (8), then through the center of the weight (9).

**! WARNING**

The wire rope must be correctly installed. Otherwise incorrect fitting will damage the wire rope and result in a potentially serious hazard.

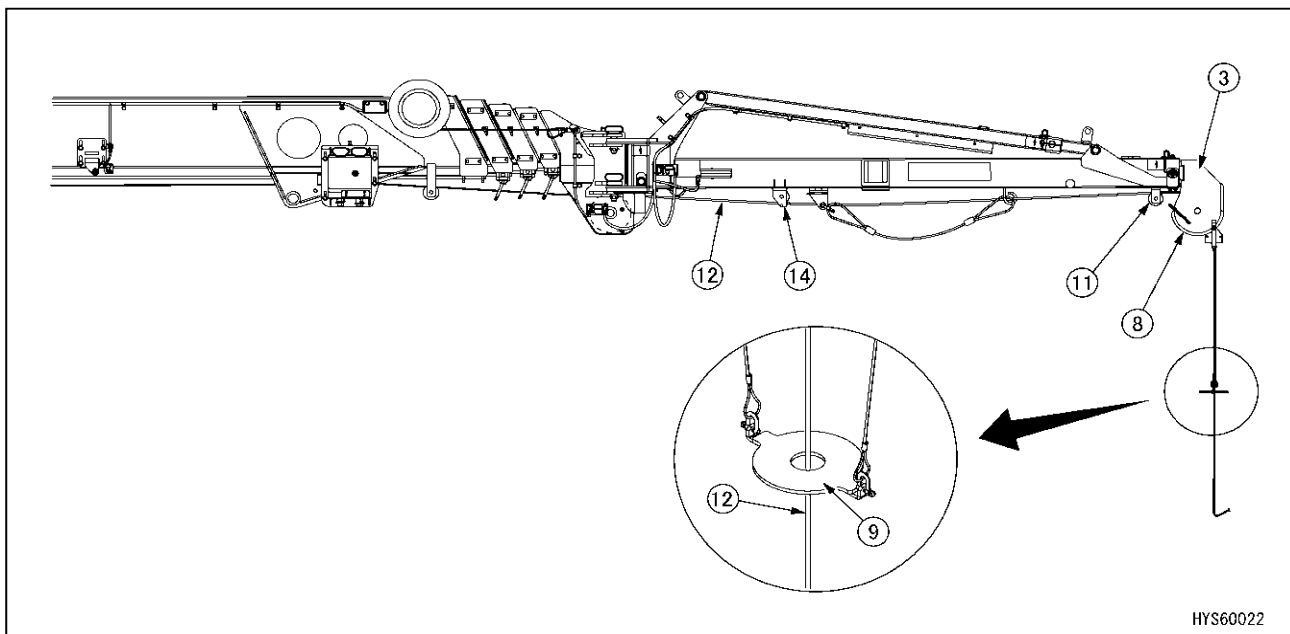



18. Put the wire rope (12) through the wire socket (37), as removed in 13 above, and set the rope wedge (41) to position (a). Pull the wire rope (12) firmly to the direction of the arrow.
19. Install the rope clip (40) to the wire rope (12). Refer to the Figure on the right for the rope clip position.
20. Insert the wire socket (37) into connection base (a) inside the hook (10). Adjust the holes (a, b) of both and insert a pin (49), then secure it with end plates (51) and bolts (50).

**NOTES**

The hook (10), pin (49), bolts (50) and end plates (51) are specific Fly-jib parts and packaged separately.

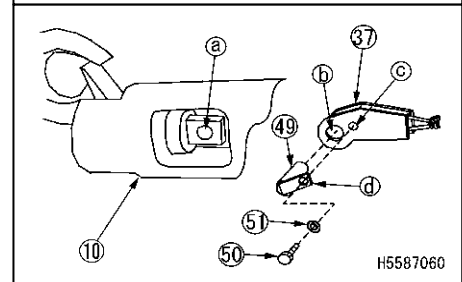
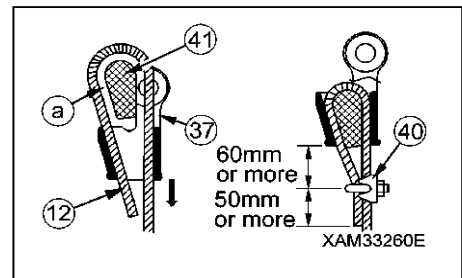



## 4.2 CHANGING OF FLY-JIB TILT ANGLE

### ⚠ CAUTION

Changing of the Fly-jib tilt angle should be always practiced without any hoisted load and only with the No.1 Fly-jib. Avoid changing the Fly-jib tilt angle with a hoisted load and/or using No.2 Fly-jib, otherwise excess load is applied to the lever block which may damage it.

### CAUTION

• This Fly-jib is adjustable to four tilt angles (0, 20, 40 and 60 degrees). Select the suitable position for the intended work.

To change the tilt angle of the Fly-jib, follow the instructions below:

1. Set the attached lever block (23) between the tilt angle adjuster outer rod (5) and inner rod (6) and take up the slack.

#### NOTES

Lever block (23) handling will be easier, when you set the lever side to the outer rod side (5).

2. Detach the linchpin (25) from the position pin (7), then use the lever block (23) and extract the position pin (7).

3. Wind up the lever block (23) to provide some slack between outer rod (5) and inner rod (6), and then lower the No.1 Fly-jib (2).

#### NOTES

When the No.1 Fly-jib (2) lowers, the inner rod (6) lowers together. Use the lever block (23) further to match the hole (H0) of the inner rod (6) for 0 degree angled Fly-jib and the hole of the outer rod (5).

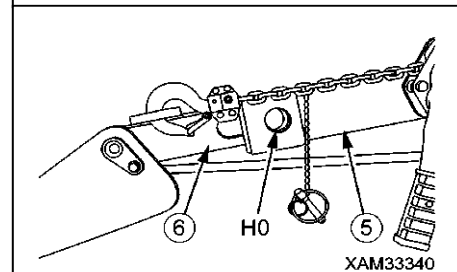
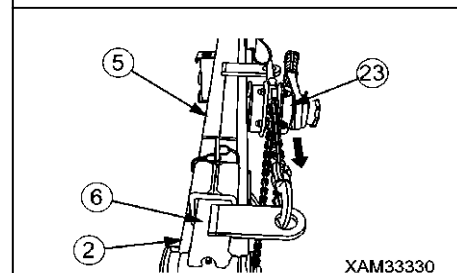
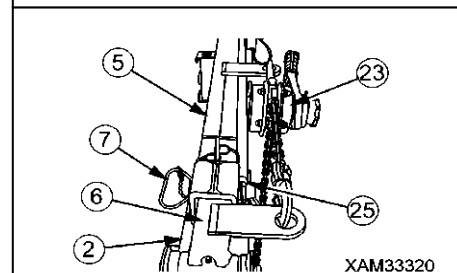
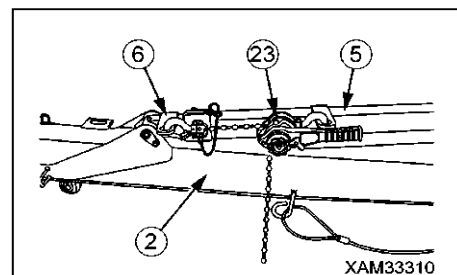

4. When the hole of the inner rod (6) for 0 degree angled Fly-jib and the hole of the outer rod (5) match, insert the position pin (7) to the holes and insert the linchpin (25). When inserted, ensure the ring is turned to lock it.
5. Remove the lever block (23).

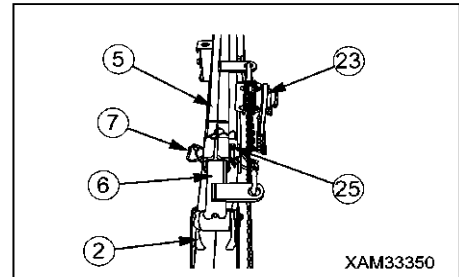

**[Posture of the 0 degree angled Fly-jib]**

**CAUTION**

The posture shown in the right figure is a posture when the Fly-jib angle is zero degrees.

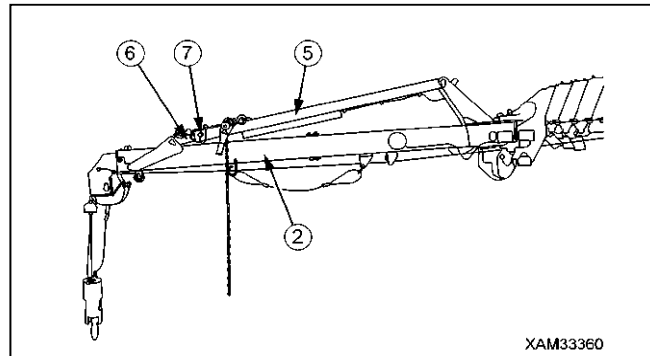

**[Posture of the 60 degrees angled Fly-jib]**

**CAUTION**

The posture in the figure below right shows that the Fly-jib is configured to 60 degrees tilt angle from [Posture of the 0 degree angled Fly-jib] as above.

To change the Fly-jib tilt angle to 60 degrees:

- (1) Continue the boom derricking operation and the procedure specified in 3 above (un-winding the lever block) alternately to allow the Fly-jib angle to be gradually adjusted.
- (2) Match the hole of the outer rod and the the hole of the inner rod for 60 degrees angled Fly-jib.
- (3) When the hole of the inner rod (6) for 60 degrees angled Fly-jib and the hole of the outer rod (5) match, insert the position pin (7) to the holes and insert the linchpin (25). When inserted, ensure the ring is turned to lock it.

- To change the Fly-jib tilt angle to 40 degrees, practice similarly as above to obtain the Fly-jib tilt angle of 40 degrees.
- To change the Fly-jib tilt angle to 20 degrees, use only the lever block function to obtain the Fly-jib tilt angle of 20 degrees.

When the Fly-jib angle is changed, the Fly-jib angle display on the monitor is switched to the angle value after the change.

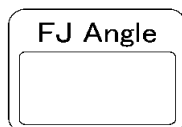
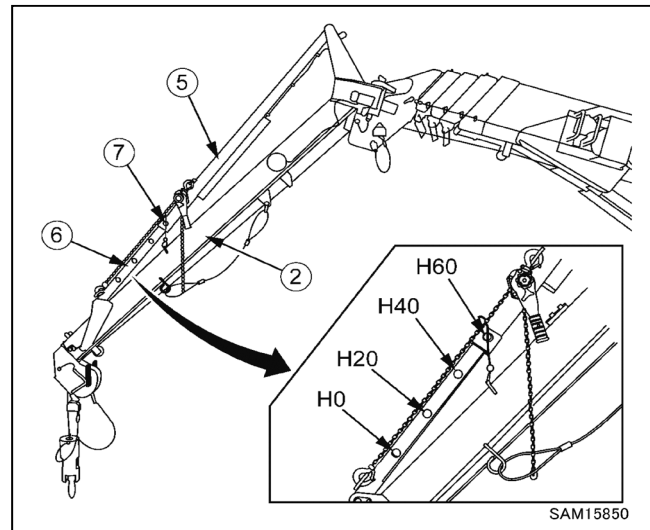

HYS60035

## 4.3 EXTENDING AND RETRACTING NO.2 FLY-JIB

### 4.3.1 EXTENDING NO.2 FLY-JIB CONFIGURED 0 DEGREE OR 20 DEGREES TILT ANGLE

To extend the No.2 Fly-jib configured 0 or 20 degrees, follow the instructions below:

1. Lower the main boom to the lowest angle.
2. Pull the linchpin (25) out from the position pin (4) in the tip of No.1 Fly-jib (2) to extract the position pin (4).

<b>NOTES</b>
Removed position pin (4) will be necessary for the later operation to secure the extended No.2 Fly-jib (3).

3. Continue hook un-winding operation and take hold of handles in the both left and right side in the tip of No.2 Fly-jib (3) and pull the No.2 Fly-jib (3) out.
4. When the No.2 Fly-jib (3) is extended, adjust both side holes of the No.1 Fly-jib (2) and No.2 Fly-jib (3) to insert the position pin (4). Apply the linchpin (25) to secure the position pin.

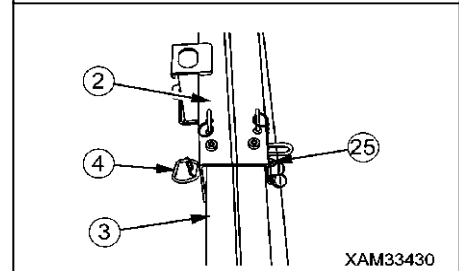
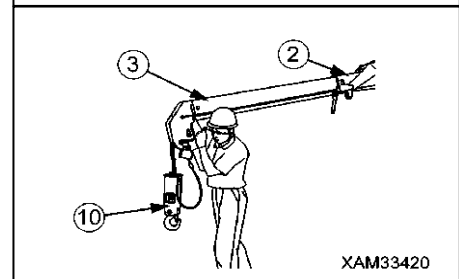
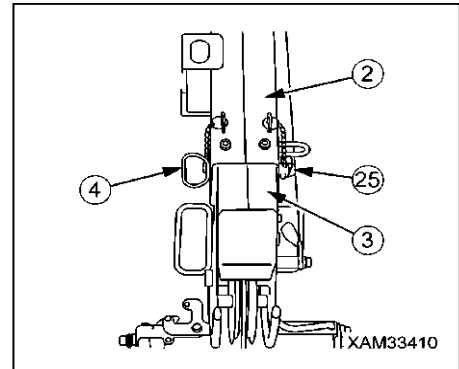

[Posture of the 20 degrees angled Fly-jib]

### CAUTION

The posture in the figure in the right shows that the No.2 Fly-jib is extended in accordance with the procedure 1 to 3 as above. In this posture, the signal indicating that Fly-jib length is two stages is transmitted to the moment limiter and the display of the number of the Fly-jib stage of the monitor is changed to "2".

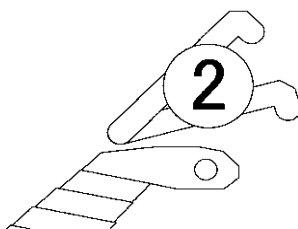

HYS60023

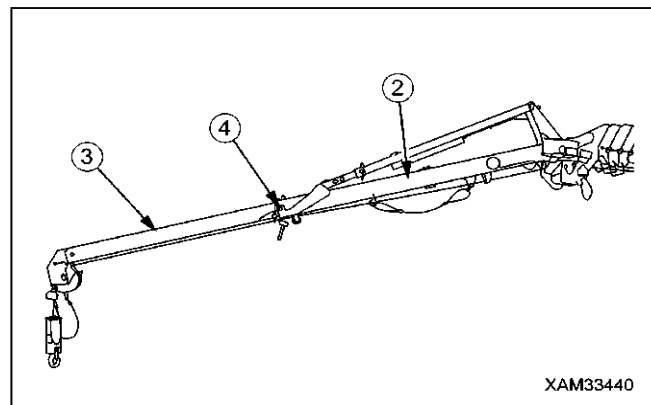



### 4.3.2 EXTENDING NO.2 FLY-JIB CONFIGURED 40 DEGREES OR 60 DEGREES TILT ANGLE

#### **⚠ WARNING**

- When the Fly-jib angle is set higher, No.2 Fly-jib may rapidly slide out when the position pin which fixes it is extracted and it may cause a serious accident resulting in death or serious injury. Before you extract the position pin, always wind up the hook close to the Fly-jib tip to prevent No.2 Fly-jib from rushing out. In case of this, be careful to avoid your hand or a part of your body being caught between the No.2 Fly-jib tip and the hook.
- When applying the hook to the Fly-jib tip, do not wind the hook with the override switch left "ON". Excessive force can break the Fly-jib. When winding up the hook, be sure to use the hook stowage switch.

To extend the No.2 Fly-jib configured at 40 or 60 degrees, follow the instructions below:

1. Keep pressing the hook stowage switch and wind up the hook (10) slowly, until it lightly touches the No.2 Fly-jib (3) tip.

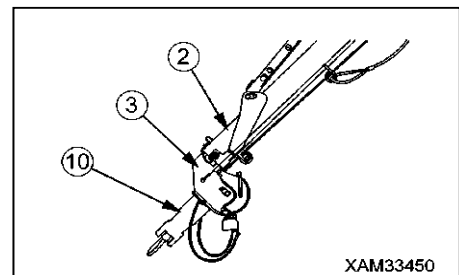

2. Pull the linchpin (25) out from the position pin (4) in the tip of No.1 Fly-jib (2) to extract the position pin (4).

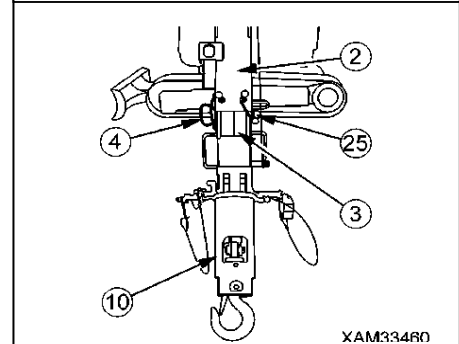

3. While repeating lowering operation of the hook and raising operation of the boom slowly and alternately, let No. 2 Fly-jib (3) gradually slide out.

#### **CAUTION**

- When the hook is un-wound, the weight of the No.2 Fly-jib (3) will slide out under it's own weight. Continuing this operation will result in No.2 Fly-jib (3) hitting the ground. To prevent this, raise the boom. Continue these operations alternately.
- If the the weight of the No.2 Fly-jib (3) cannot make it slide out, take hold of handles in the both left and right side at the tip of No.2 Fly-jib (3) and pull the No.2 Fly-jib (3) out.

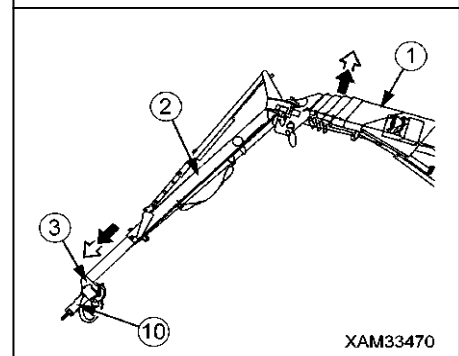

4. When the No.2 Fly-jib (3) is extended, adjust both side holes of No.1 Fly-jib (2) and No.2 Fly-jib (3) to insert the position pin (4). Fit the linchpin (25) to secure the position pin.

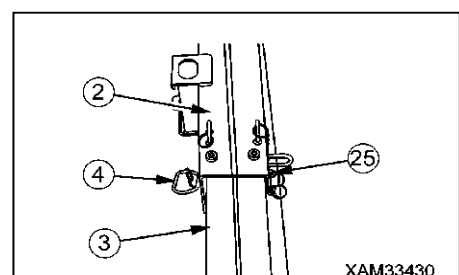

5. Un-wind the hook down so that it separates from the No.2 Fly-jib (3).



[Posture of the 60 degrees angled Fly-jib]

**CAUTION**

The posture in the figure on the right shows that the No.2 Fly-jib is extended in accordance with the procedure 1.~ 4. as above. In this posture, the signal indicating that Fly-jib length is two stages is transmitted to the moment limiter and the display of the number of the Fly-jib stage of the monitor is changed to "2".

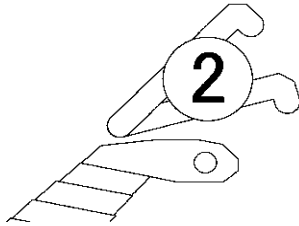

HYS60023

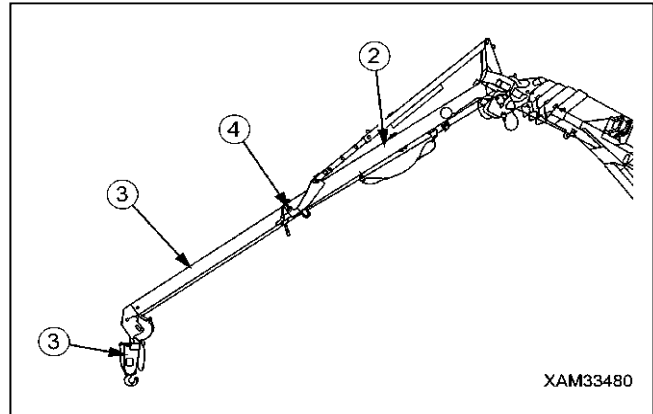

XAM33480

### 4.3.3 RETRACTING OF No.2 FLY-JIB

#### **⚠ WARNING**

When the Fly-jib angle is set higher, No.2 Fly-jib may rapidly slide out when the position pin which fixes it is extracted, which may cause a serious accident resulting in death or serious injury. Before you extract the position pin, always wind up the hook close to the Fly-jib tip to prevent No.2 Fly-jib from rushing out. In such events, be careful to avoid your hand or part of your body being caught between the No.2 Fly-jib tip and the hook.

To retract the No.2 Fly-jib, follow the instructions below:

1. Keep pressing the hook stowage switch and wind up the hook (10) slowly, until it lightly touches the No.2 Fly-jib (3) tip.

2. Pull the linchpin (25) out from the position pin (4) in the tip of No.1 Fly-jib (2) to extract the position pin (4).

#### **NOTES**

Removed position pin (4) will be necessary for the later operation to secure the retracted No.2 Fly-jib (3).

3. Keep pressing the hook stowage switch and continue the hook winding up operation and the boom lowering operation alternately, so that the No.2 Fly-jib (3) is slowly retracted.

#### **CAUTION**

When the hook is wound up, No.2 Fly-jib (3) is retracted by the force of the winch. During such practices, the Fly-jib No.2 (3) may not be smoothly drawn in due to its angle. In such an event, lower the boom or take hold of handles on the both left and right side at the tip of No.2 Fly-jib (3) and push No.2 Fly-jib (3) in.

4. When No.2 Fly-jib (3) is retracted, adjust both side holes of No.1 Fly-jib (2) and No.2 Fly-jib (3) to insert the position pin (4). Apply the linchpin (25) to secure the position pin.
5. Un-wind the hook down so that it separates from the No.2 Fly-jib (3).

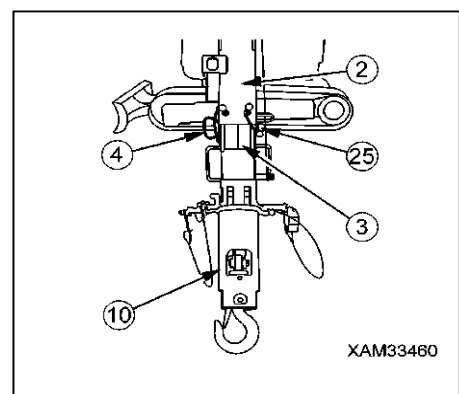
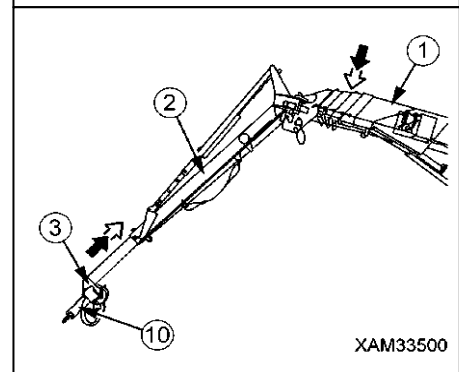
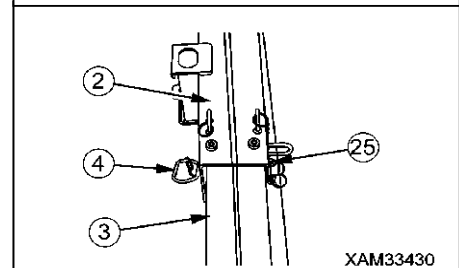
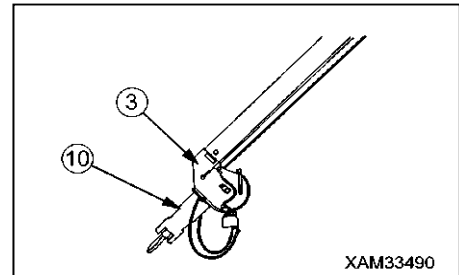

## 4.4 STOWAGE OF FLY-JIB

### NOTES

When the No.2 Fly-jib (3) is extended, refer to section; “FLY-JIB, 4.3 Extending and Retracting No.2 Fly-jib” and retract the No.2 Fly-jib (3) correctly.

1. Hang the hook (10) for Fly-jib to the hook stowing wire (13) on the underside of the Fly-jib (2).

### NOTES

Allow the wire rope (12) to be adequately slack.

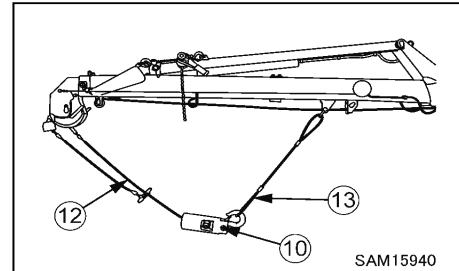

2. Swap the harness connection part (19) and (20) as shown below to switch and connect fly-jib angle and length detector.

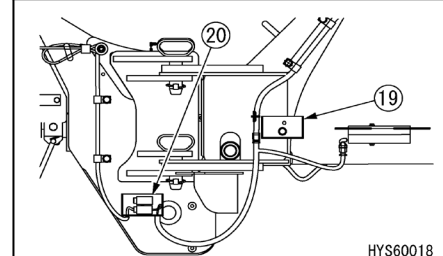

- (1) Disconnect the connector for stowage (33) of the harness connection (20) on the main boom side from the connector for stowage (35). Then, disconnect the wiring connector (34), including the clip, connected to the wiring connector (36).

Before harness exchange;  
the Main boom side:

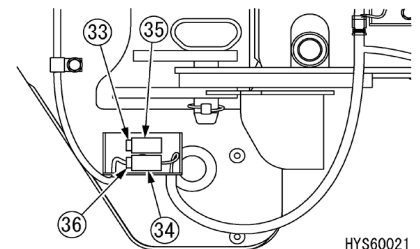

After harness exchange;  
Main boom side:

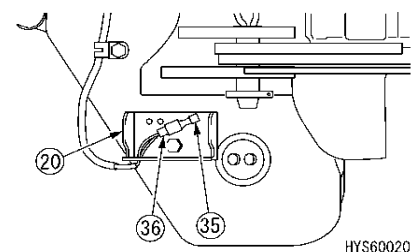

- (2) Connect the harness connector (36), as extracted in (1) above, to the storage connector (35).

After harness exchange;  
Fly-jib side:

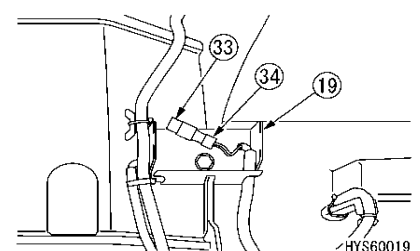

### NOTES

Ensure that electric wiring of the harness connector (34) is guided out of the hole cut in the bottom of the harness connection part (19).

- (3) Connect the connector for stowage (33) disconnected in Section (1) to the wiring connector (34) and secure them to the harness connection part (19).

3. Swap the harness connection part (17) and (18) as shown below to switch and connect over-hoist detector.

- (1) Open the cover of the harness connection part (17: Fly-jib side) and extract the harness plug (32) in the connector (29).

**NOTES**

The removed harness plug (32) will be later connected into a connector in the harness connection part (18: Main boom side).

- (2) Disconnect the dummy plug (30) connected to the connector (31) of the harness connection (18) on the main boom side.

**NOTES**

The removed dummy plug (30) will be later connected into a connector in the harness connection part (17: Fly-jib side).

- (3) Connect the wiring connector (32) disconnected in Section (1) to the connector (31).

**NOTES**

Ensure that wires of the harness plug (32) and connector (31) are guided out of the connector box through the hole cut in the bottom left.

- (4) Connect the dummy plug (30) disconnected in Section (2) to the connector (29) and close the cover.

**CAUTION**

Don't forget to install the dummy plug (30) into the connector (29) in the harness connection part (17: Fly-jib side). If not, the absence of the dummy plug may cause mis-function of the over-hoist detector. In such event, it may cause the hook or load to drop and result in a serious hazard.

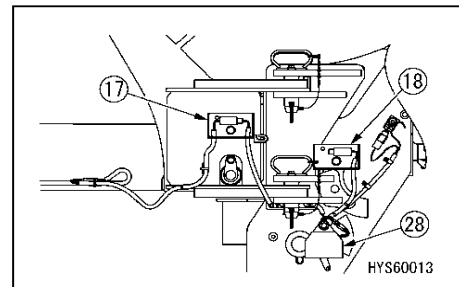

Before harness exchange;  
Fly-jib side:

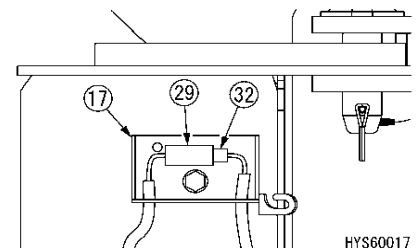

Before harness exchange;  
Main boom side:

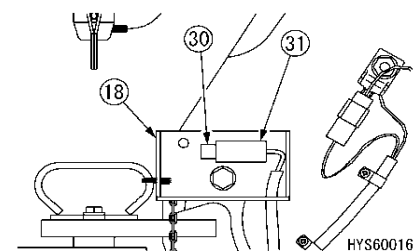

After harness exchange;  
Main boom side:

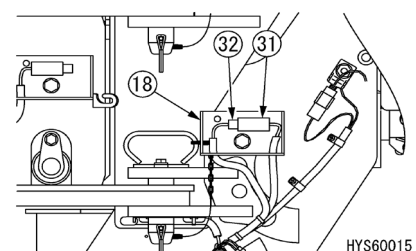

After harness exchange;  
Fly-jib side:

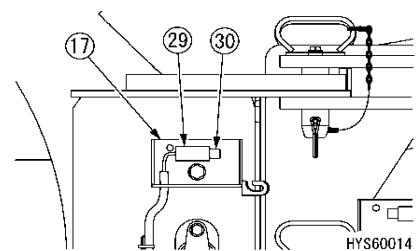

4. Remove linchpins of the position pins (A1, A2) installed in the holes (C, D) of the bracket (27) on the left side of the main boom tip and pull out the position pins (A1, A2) from the holes of the bracket (27).

**NOTES**

- The removed position pins (A1, A2) will be used later for fixing and stowage of the Fly-jib.

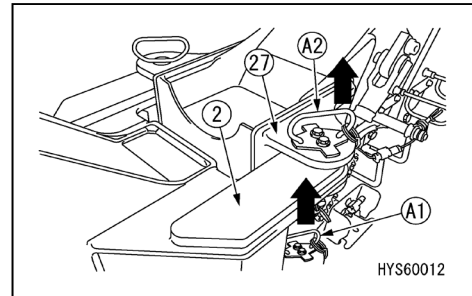

**CAUTION**

If the position pins (A1, A2) cannot be pulled out, pull them out by following the procedure below.

- (1) Remove the bolt (H2) fixing the handle (H1) with the linchpins left attached.
- (2) Hang the removed handle (H1) on the hook (H3).
- (3) The pins fall and are removed when the Fly-jib tip is shaken up and down.

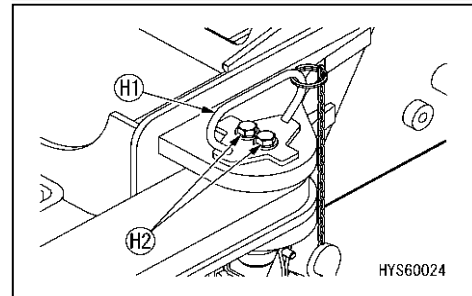

**CAUTION**

When removing the handle (H1), be sure to fasten it to the main body of the pins to the specified torque.

★ Tightening torque: 27.0 – 34.0 N·m

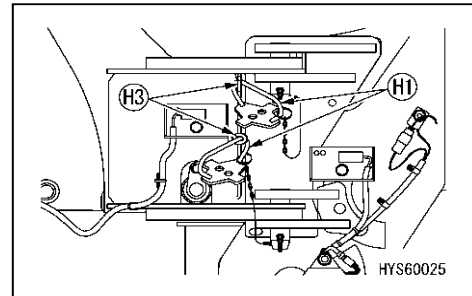
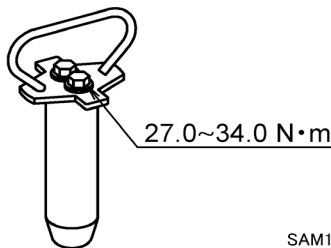

5. Turn the No.1 Fly-jib (2) around the position pins (C1, C2) on the right side of the Main boom tip and stow it into the Fly-jib bracket A (21) on the side face of the Main boom.

**NOTES**

When rotating the No. 1 Fly-jib (2), pull its tip. When the No.1 Fly-jib (2) turns too rapidly, hold it to stop turning.

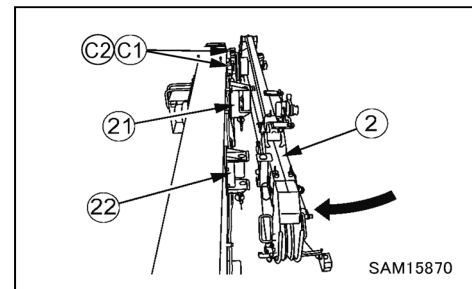

6. Adjust the connection hole of No.1 Fly-jib (2) and hole of Fly-jib bracket A (21) .

7. Insert the position pin (A2) into the bracket (27) on the left side of the Main boom tip. At this time, be sure to turn over the ring of the linchpin to lock securely.

**NOTES**

The position pin (A1) is used later for fixing the Fly-jib.

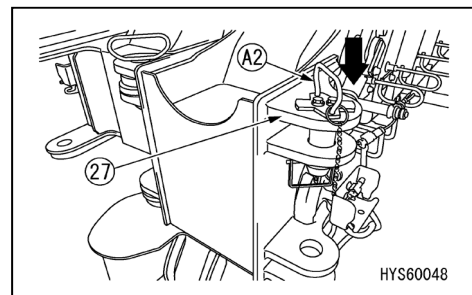



8. When the hole of the No. 1 Fly-jib (2) connection is aligned with the hole of the Fly-jib stowage bracket A (21), insert the position pin (B2) into the hole and insert the linchpin. At this time, be sure to turn over the ring to lock securely.

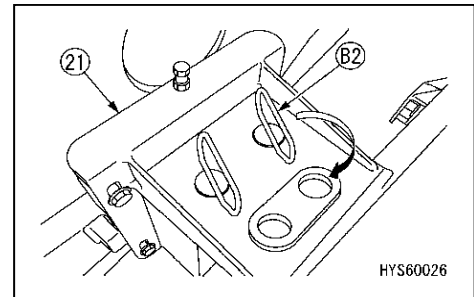

### ⚠ WARNING

- Do not remove the position pins (C1, C2) from the bracket (26) until the position pin (B2) is securely inserted into the stowage bracket A (21) hole and the Fly-jib is fixed. Incorrect fitting order may cause a serious hazard.
- The position pin (B2) must always be inserted downward from the upper side. Otherwise, where it is inserted upward from the underside, the position pin could easily drop down to cause the Fly-jib to collapse and may cause a serious hazard.

### CAUTION

When the position pins (B2, C1, C2) are fitted in both holes of the bracket (26) on the right side of the Main boom tip and Fly-jib bracket A (21), the Main boom telescoping must not be operated. If operated it will critically damage the Fly-jib and Main boom.

9. Pull the linchpin out from the position pins (C1, C2) placed in the bracket (26) hole on the right side of the Main boom tip, to pull out the position pins (C1, C2).

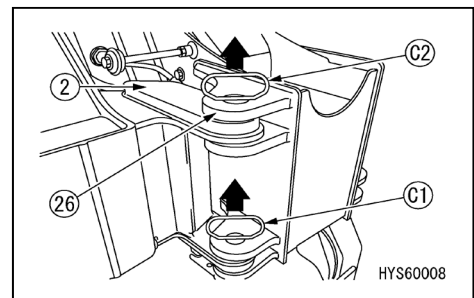

10. Slide the No. 1 Fly-jib (2) sideways to move it away from the bracket (26) on the right side of the Main boom tip.

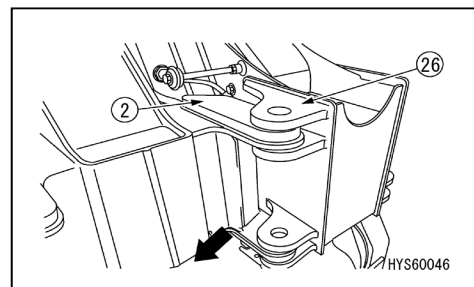

11. Insert the position pins (C1, C2) into the bracket (26) on the right side of the Main boom tip. At this time, be sure to turn over the ring of the linchpin to lock securely.

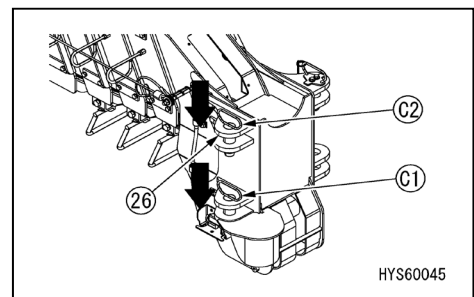

12. Pull the No. 1 Fly-jib (2) toward the tip side.

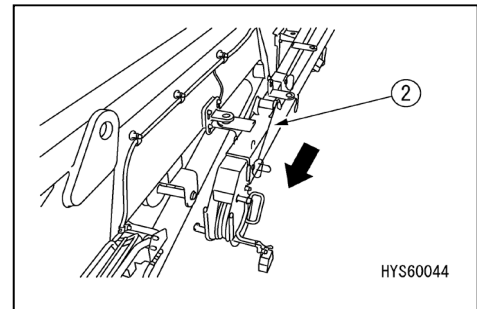

13. Push the No.1 Fly-jib (2) into the Fly-jib bracket B (22), then insert the position pin (A1) into the hole of the Fly-jib bracket B (22). Use the linchpin to secure the position pin.

**⚠ WARNING**

The position pin (A1) must always be inserted downward from the upper side. When it is inserted upward from the underside, the position pin could easily drop down to cause the Fly-jib to drop and may cause a serious hazard.

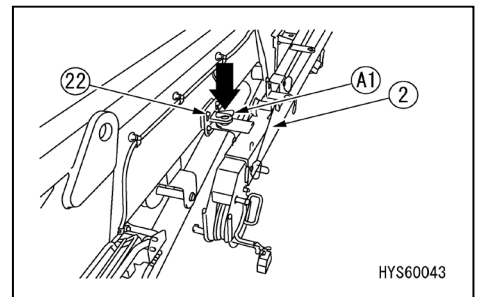

14. Pull the linchpin of the position pin (B1) stored in the Fly-jib storage bracket A (21) and pull out the position pin (B1). Insert the position pin (B1) into the hole closest to the front and insert the linchpin. At this time, be sure to turn over the ring to lock securely.

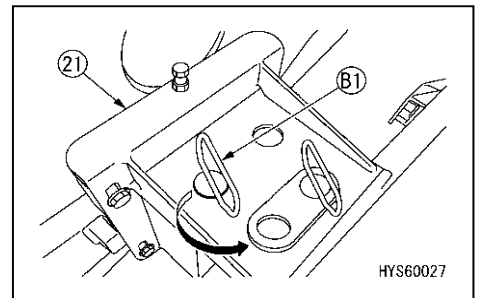

15. Hang the single hook (10) on the hook stowage rope (13). While pressing the hook stowage switch, perform winch raising operation to remove the slack of the wire rope (12).

**⚠ CAUTION**

Do not perform hook stowage operation with the override switch left ON. The hook stowage mode is not available and may result in damage to the bracket for the hook stowage wire rope (13), main boom, or wire rope (12). Always use the hook stowage switch to stow the hook.

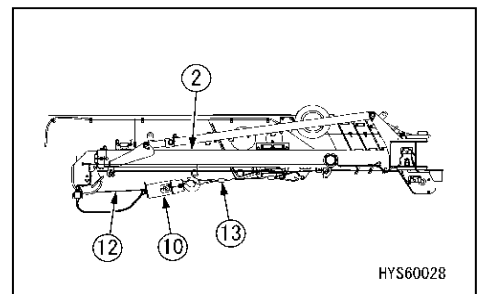

**CAUTION**

In the case of the Fly-jib mode with the Fly-jib in a stowage condition, the monitor display is as shown on the right figure. Either switch to the main boom mode or install the Fly-jib. For the detailed operation method, see “5.1.2 Monitor display when Fly-jib is stowed”.

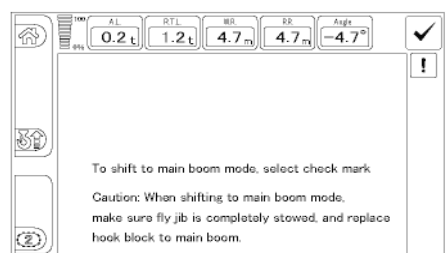

SAM19180





## 4.5 REMOVAL OF FLY-JIB

### NOTES

This section explains a method of removing the whole Fly-jib from the main body of the machine. Fully retract the main boom and set it to horizontal before using the crane to remove the Fly-jib.

### **⚠ WARNING**

- **Always stop the engine during work. If work is performed with the engine running, the machine can start moving unexpectedly, causing a serious accident.**
- **Only use a sling (e.g. wire rope and shackles) which has sufficient strength when lifting the Fly-jib.**
- **Never perform work while stepping on the crawler. You may miss your footing and fall down, causing serious physical injury. Be sure to set a stable workbench when working above ground level.**
- **When work is performed on the main boom with the Fly-jib removed from the main body, setting change of the moment limiter is required. Be sure to contact our sales service agency. If the machine is used without changing the setting of the moment limiter, a serious accident, such as damage or overturning of the machine, can be caused.**

### **CAUTION**

**A person who performs lifting operation of the Fly-jib using a crane must obtain the qualification if there are local laws or regulations. If there are no such laws or regulations, the person must be well trained and experienced.**



1. Pull the linchpin of the position pin (B1) of the stowage bracket A (21) and pull out the position pin (B1). Insert the removed position pin (B1) into the hole for pin storage at the back of the stowage bracket A (21). Securely lock with the linchpin after insertion.

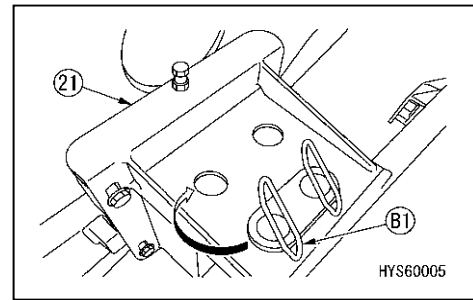

2. Pull the linchpin out from the position pin (A1) in the Fly-jib bracket B (22) to pull out the position pin (A1).

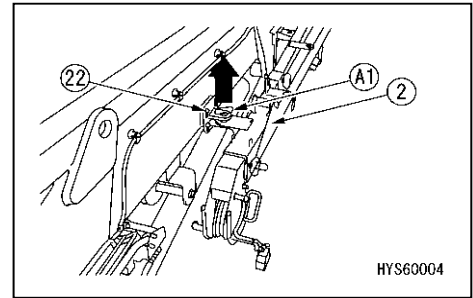

3. Pull out the position pins (C1, C2) from the bracket (26) on the right side of the main boom tip.

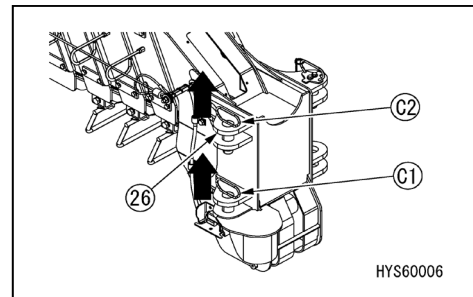

4. Holding the handle (H4) of the No. 1 Fly-jib (2) with the position pin (B2) of the stowage bracket A (21) as a fulcrum, pull it out to the Main boom tip side and align the bracket (26) holes (A, B) on the right side of the Main boom tip with the hole positions of the No. 1 Fly-jib (2) connection.

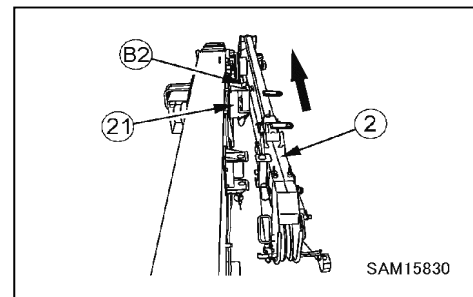

**CAUTION**

When pulling out the No. 1 Fly-jib (2), hold the handle (H4) instead of the pin holes to perform work.

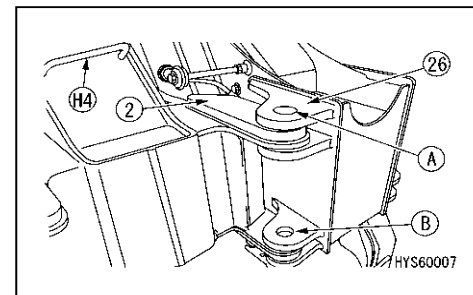



5. Once the connection hole of the No.1 Fly-jib (2) and the holes (A, B) of the bracket (26) on the right side of the Main boom tip are aligned, insert the position pins (C1, C2) to the hole then secure it with the linchpin.

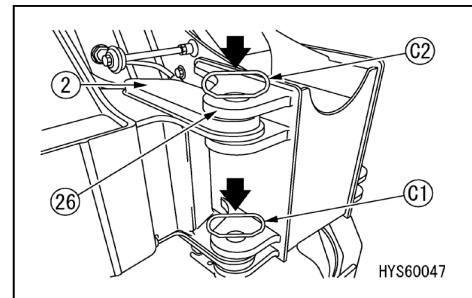

### ⚠ WARNING

- Do not remove the position pin (B2) from the fly-jib bracket A (21) until the position pin (C1, C2) is fully inserted into the hole of the bracket (21). Incorrect fitting order may cause a serious hazard.
- The position pins (C1, C2) must always be inserted downward from upper side. If it is inserted from the underside it could drop out allowing the Fly-jib to collapse causing a serious hazard.

### CAUTION

When the position pins (B2, C1, C2) are fitted into both holes of the bracket (26) on the right side of the Main boom tip and Fly-jib bracket A (21), Main boom telescoping must not be operated. This operation will critically damage the Fly-jib and Main boom.

6. Pull the linchpin out from the position pin (B2) in the Fly-jib bracket A (21) to pull out the position pin (B2).

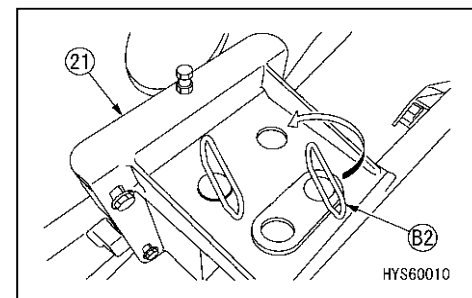

7. Pull the linchpin of the position pin (A2) of the bracket (27) on the left side of the main boom tip and pull out the position pin (A2).

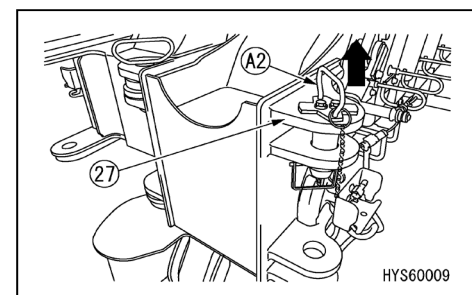

8. Slide the No.1 Fly-jib (2) forward through the position pins (C1, C2) on the right side of the Main boom tip as a point of support, and then turn it toward to the front of the Main boom.

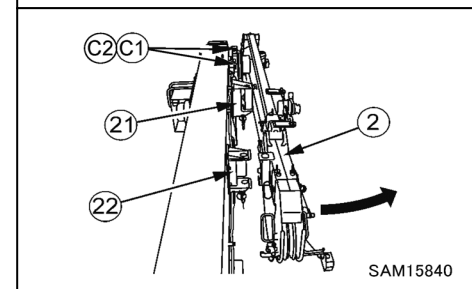

9. Hang wire rope for lifting on the No. 1 Fly-jib (2) and sling it temporarily.

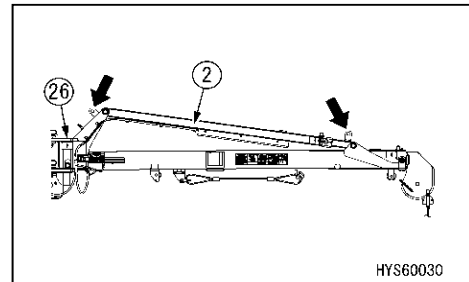

HYS60030

10. Pull out the linchpins of the position pins (C1, C2) and draw out the position pins (C1, C2).

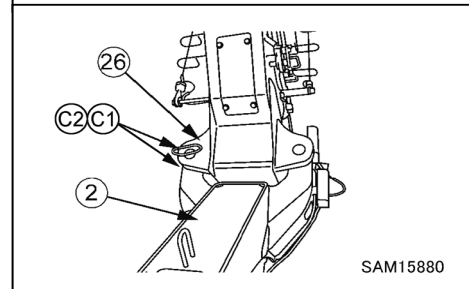

SAM15880

11. Operate the crane and lift the No. 1 Fly-jib (2) to remove.

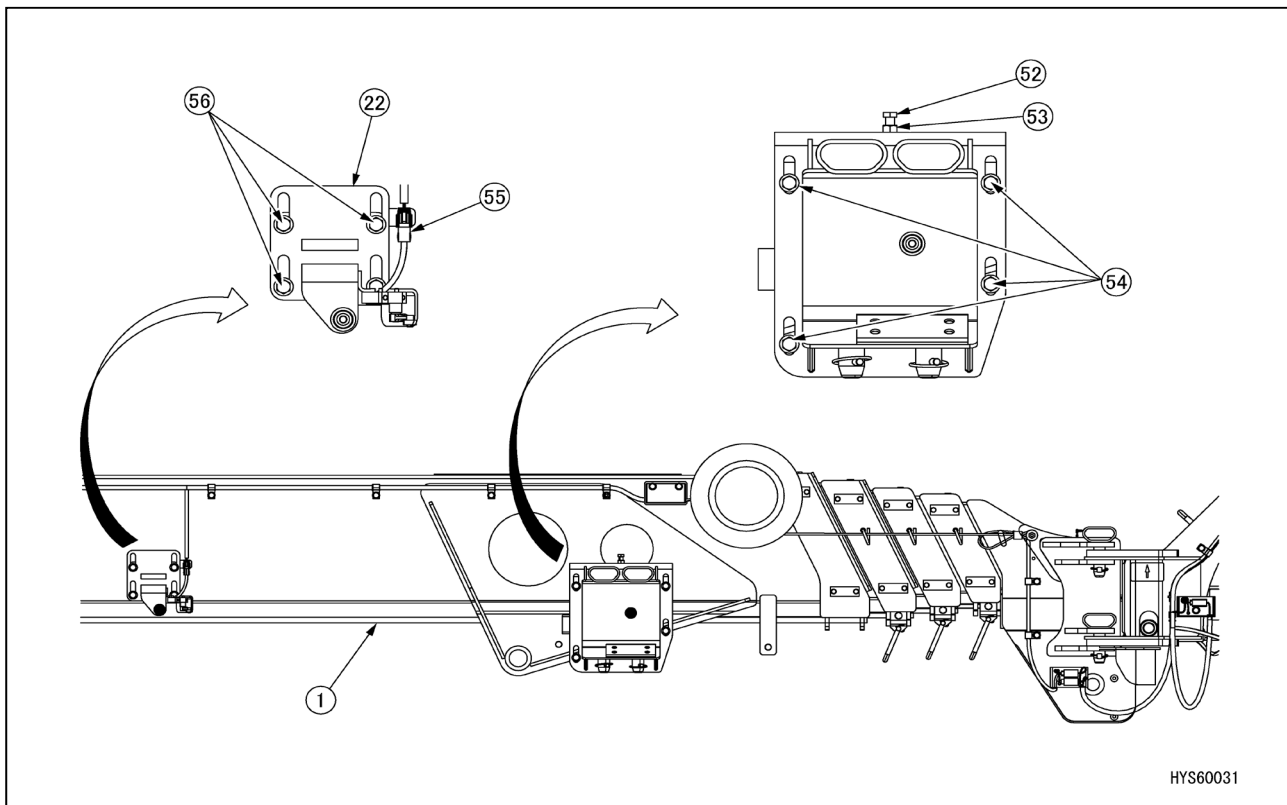

HYS60031

12. Loosen the nut (53) of the Fly-jib storage bracket A (21) and turn the adjusting bolt (52) counterclockwise to loosen.

13. Remove the Fly-jib storage bracket A (21) from the main boom (1) by unscrewing 4 mounting bolts (54).

14. Disconnect the wiring connector (55) of the Fly-jib storage detection limit switch at the side of the Fly-jib storage bracket B (22).

15. Remove the Fly-jib storage bracket B (22) from the main boom (1) by unscrewing 4 mounting bolts (56).

16. Detach the counterweight upper cover (60).

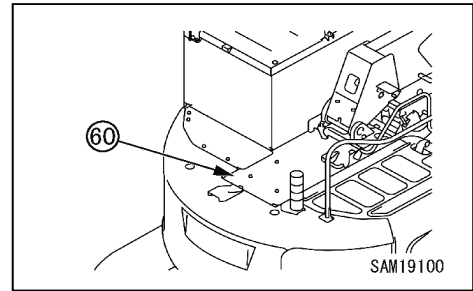

17. Disconnect the bottommost harness (65) connector on the cab and attach the short connector (61) provided.

Connector: CN-BM5

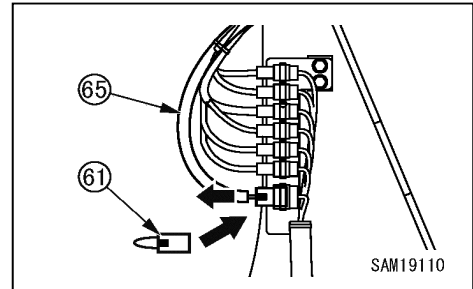

18. Remove all harness clips (62) and bands (63).

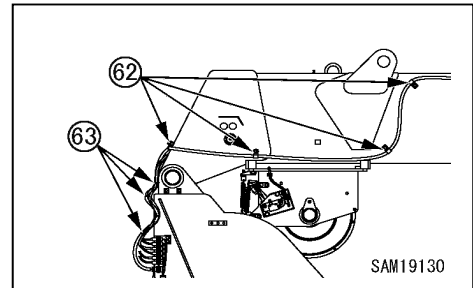

19. Remove the connector cover (64), disconnect the connector inside, and remove the harness (65).

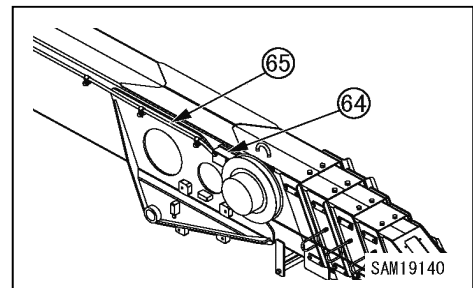

20. Remove the nut (66) and remove the cable (68). Disconnect the connector from the harness connection part (20) at the end of the boom head and wind the cable (68) onto the cable reel (67).

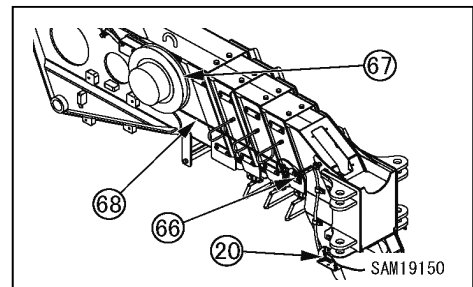

21. Remove the cable reel (67). The cable reel (67) is secured by a bolt from the rear.

22. Reattach the counterweight upper cover (60).

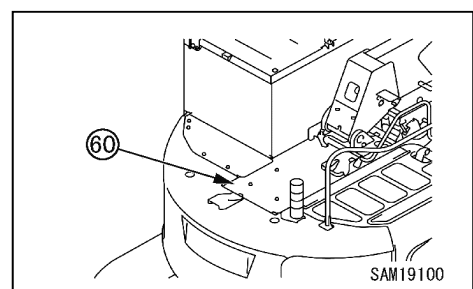



## 4.6 INSTALLATION OF FLY-JIB

### NOTES

This section explains a method of installing the whole Fly-jib to the main body of the machine. Fully retract the main boom and set it to horizontal before using the crane to install the Fly-jib.

### ⚠ WARNING

- Always stop the engine during work. If work is performed with the engine running, the machine can start moving unexpectedly, causing a serious accident.
- Only use a sling (e.g. wire rope and shackles) which has sufficient strength when lifting the Fly-jib.
- Never perform work while stepping on the crawler. You may miss your footing and fall down, causing serious physical injury. Be sure to set a stable workbench when working above ground level.

### CAUTION

A person who performs lifting operation of the Fly-jib using a crane must obtain the qualification if there are local laws or regulations. If there are no such laws or regulations, the person must be well trained and experienced.

1. Detach the counterweight upper cover (60).

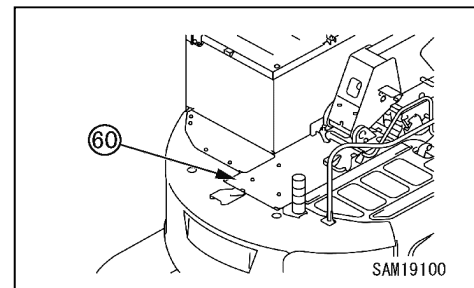

2. Remove the bottommost short connector (61) on the cab and connect the harness (65).

Connector: CN-BM5

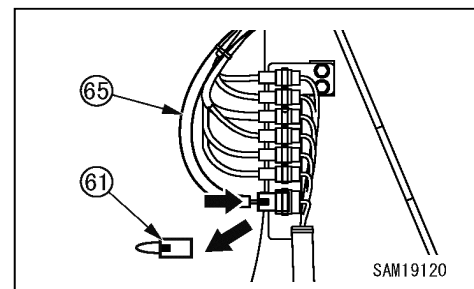

3. Attach the cable reel (67). The cable reel (67) is secured by a bolt from the rear.

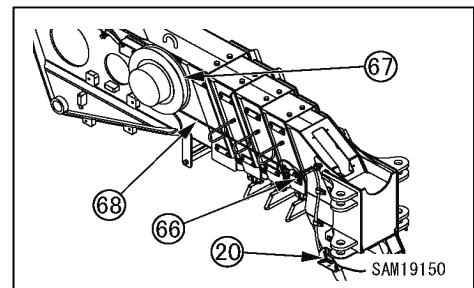



4. Pull the cable (68) out from the cable reel (67). Secure with the nut (66) with washers (69) and (70) inserted in between. Finally, connect the connector to the harness connection part (20) at the end of the boom head.

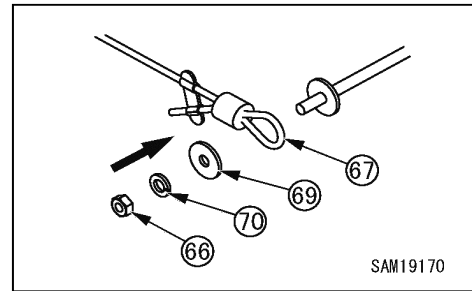

5. Connect the harness (65) to the cable reel (67) connector and attach the connector cover (64).

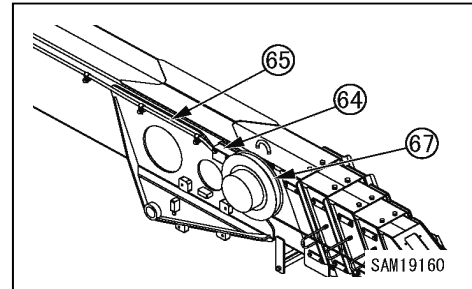

6. Attach the harness clips (62) and bands (63).

<b>NOTES</b>
Attach the bands (63) at points where securing the harness appears necessary.

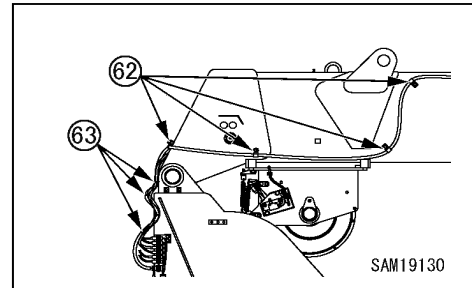

7. Reattach the counterweight upper cover (60).

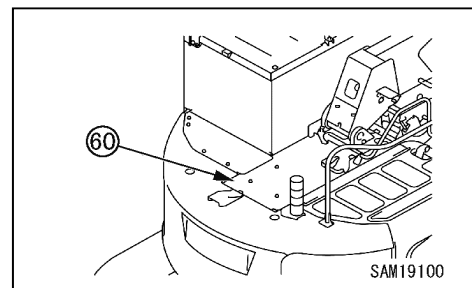

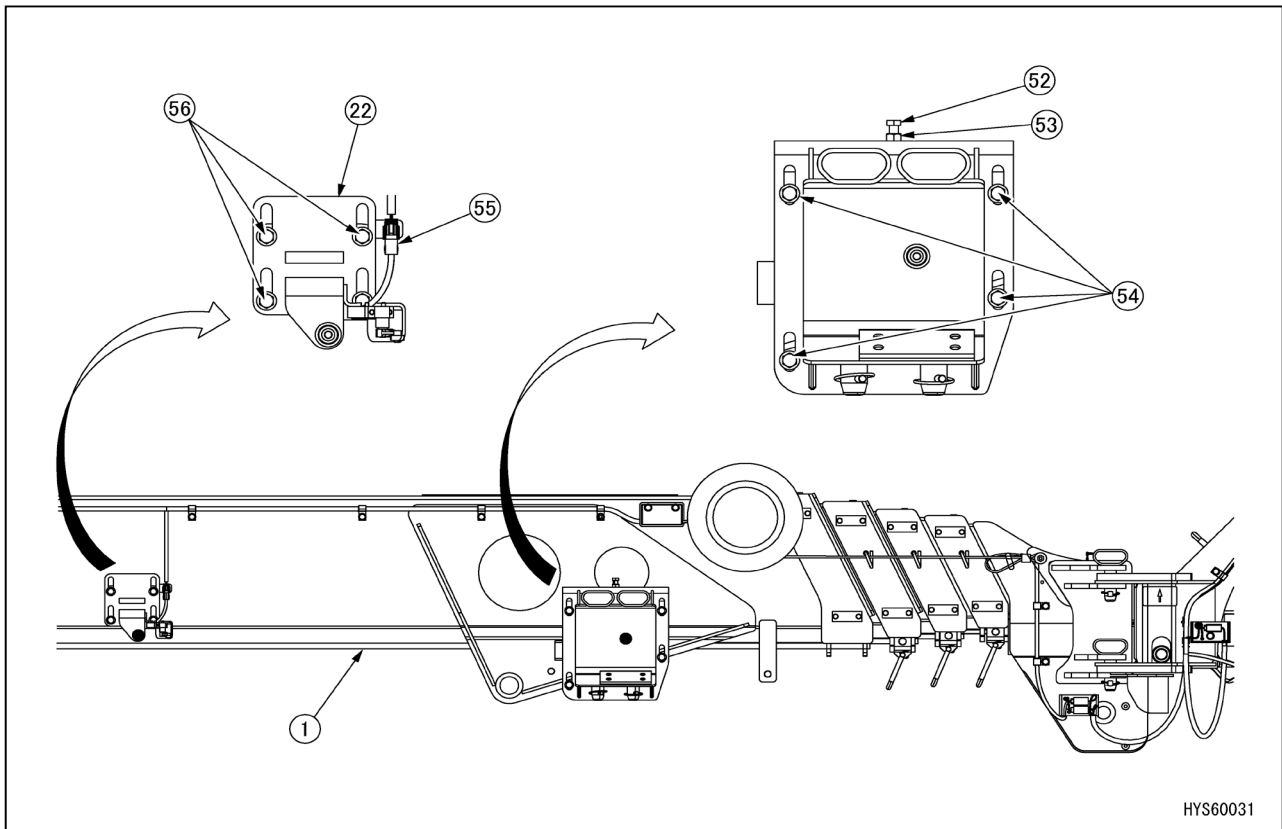

HYS60031

8. Set the Fly-jib storage bracket B (22) on the mounting position of the main boom (1) and lightly tighten it with 4 mounting bolts (56).
9. Connect the wiring connector (55) of the Fly-jib storage detection limit switch at the side of the Fly-jib storage bracket B (22).
10. Set the Fly-jib storage bracket A (21) on the mounting position of the main boom (1) and lightly tighten it with 4 mounting bolts (54).
11. Tighten the adjusting bolt (52), with the nut (53) attached, of the Fly-jib storage bracket A (21) until it contacts the stopper.

### NOTES

Keep the nut (53) tightened lightly when installing the Fly-jib because positioning is adjusted.

12. Lift the No. 1 Fly-jib (2) by operating the crane and bring it close to the bracket (26) of the main boom tip.

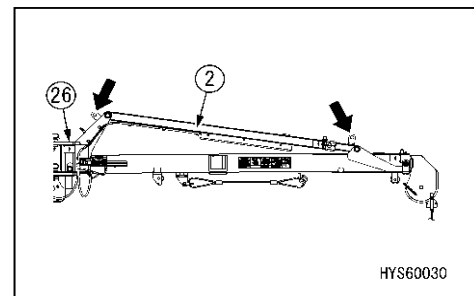

HYS60030



13. Insert the lifted No. 1 Fly-jib (2) into the brackets (26), (27) and align the holes (A, B) of the bracket (26) with the holes of the No. 1 Fly-jib (2) connection.

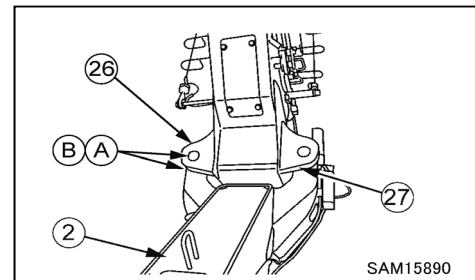

14. When the holes (A, B) of the bracket (26) on the right side of the main boom tip is aligned with the holes of the No. 1 Fly-jib (2) connection, insert the position pins (C1, C2) into the holes and insert the linchpins. At this time, be sure to turn over the ring to lock securely.

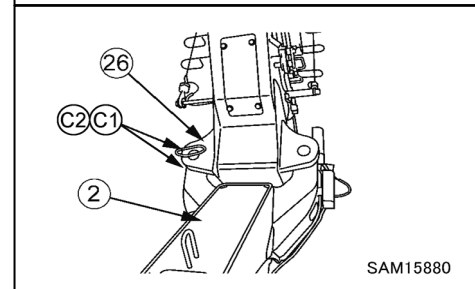

### ⚠ WARNING

- Do not remove the wire rope for lifting that lifts the No. 1 Fly-jib (2) until the position pin (15) is securely inserted into the hole of the bracket (26). This could cause a serious accident.
- Be sure to insert the position pin (15) in a downward direction from the above. If it is inserted in an upward direction from the lower part, the position pins could fall off and the Fly-jib could drop, causing a serious accident.

15. Remove the wire rope for lifting hung on the No. 1 Fly-jib (2).

16. Using the position pins (C1, C2) on the right side of the main boom tip as a fulcrum, rotate the No. 1 Fly-jib (2) and place it in the Fly-jib stowage bracket A (21) on the side of the main boom.

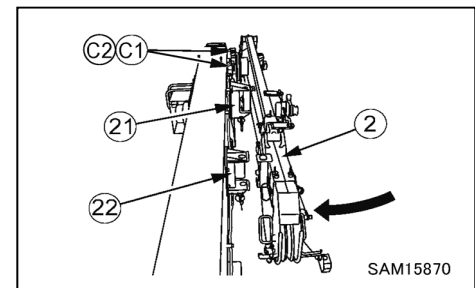

### NOTES

When rotating the No. 1 Fly-jib (2), pull its tip. If the No. 1 Fly-jib (2) rotates fast, try to hold it back.

17. Make the following adjustments so that the No. 1 Fly-jib (2) connection can be easily fit in the Fly-jib stowage brackets A (21), B (22).

- (1) After temporarily fixing the bracket A (21) with the mounting bolt (54), turn the adjusting bolt (52) to adjust the height of bracket A (21).
- (2) When the height of bracket A (21) is adjusted, temporarily fix the bracket B (22) with the mounting bolt (56) and adjust the height.
- (3) Remove the No. 1 Fly-jib (2) from the brackets A (21) and B (22) once and check the adjustment result.
- (4) If the adjustment result is good, tighten the nut (53) of the adjusting bolt (52) to securely lock it.
- (5) Finally, tighten the mounting bolt (54) of the bracket A (21) and the mounting bolt (56) of the bracket B (22) with the specified torque.

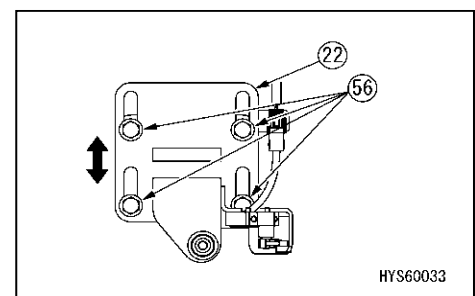
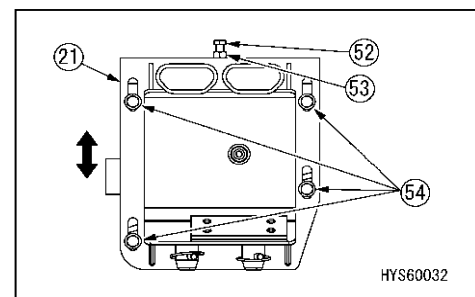

★ Tightening torque: 113 N·m (98 - 123 N·m)



18. Align the hole of the No. 1 Fly-jib (2) connection with the hole of the Fly-jib stowage bracket A (21).

19. Insert the position pin (A2) into the bracket (27) on the left side of the Main boom tip. At this time, be sure to turn over the ring of the linchpin to lock securely.

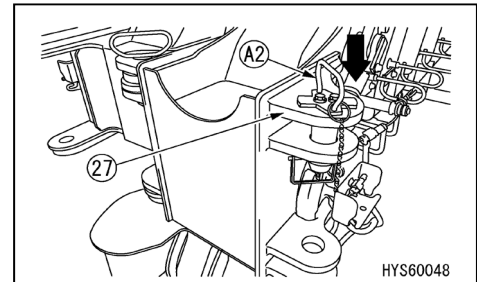

**NOTES**

The position pin (A1) will be used later for fixing the Fly-jib.

20. When the hole of the No. 1 Fly-jib (2) connection is aligned with the hole of the Fly-jib stowage bracket A (21), insert the position pin (B2) into the hole and insert the linchpin. At this time, be sure to turn over the ring to lock securely.

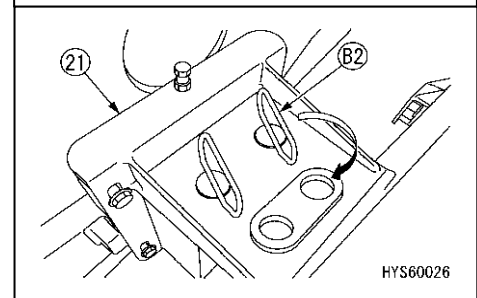

**⚠ WARNING**

- Do not remove the position pins (C1, C2) from the bracket (26) until the position pin (B2) is securely inserted into the stowage bracket A (21) hole and the Fly-jib is fixed. This could cause a serious accident.
- Be sure to insert the position pin (B2) in a downward direction from the above. If they are inserted in an upward direction from the lower part, the position pins could fall off and the Fly-jib could drop, causing a serious accident.

**CAUTION**

Do not perform extension and retraction operation of the main boom when the position pins (B2, C1, C2) are inserted into both holes of the bracket (26) on the right side of the main boom tip and the Fly-jib bracket A (21). This can cause major damage to the Fly-jib or main boom.

21. Remove the linchpins of the position pins (C1, C2) installed in the bracket (26) hole on the right side of the main boom tip and pull out the position pins (C1, C2).

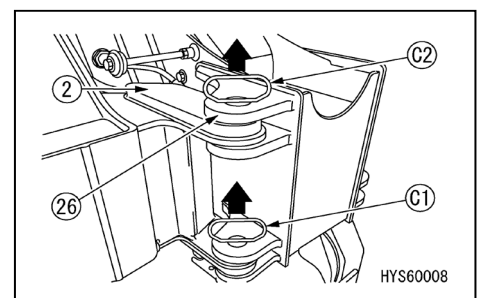

22. Slide the No. 1 Fly-jib (2) sideways to move it away from the bracket (26) on the right side of the Main boom tip.

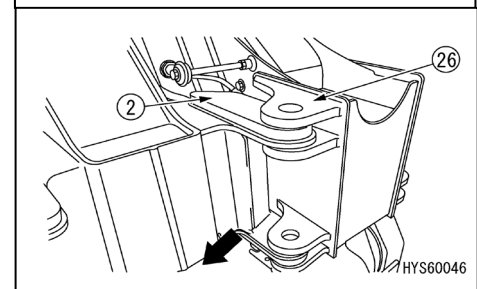

23. Insert the position pins (C1, C2) into the bracket (26) on the right side of the Main boom tip. At this time, be sure to turn over the ring of the linchpin to lock securely.

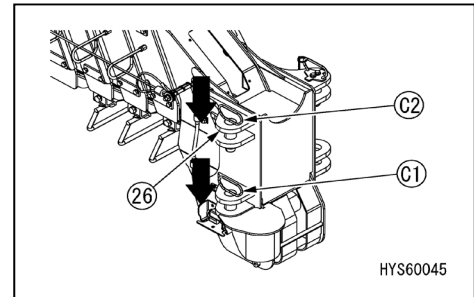

24. Pull the No. 1 Fly-jib (2) toward the tip side.

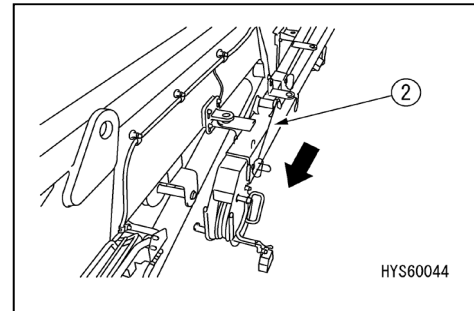

25. After pushing the No. 1 Fly-jib (2) into the Fly-jib stowage bracket B (22), insert the position pin (A1) into the Fly-jib stowage bracket B (22) hole and insert the linchpin. At this time, be sure to turn over the ring to lock securely.

**⚠ WARNING**

Be sure to insert the position pin (A1) in a downward direction from the above. If they are inserted in an upward direction from the lower part, the position pins could fall off and the Fly-jib could drop, causing a serious accident.

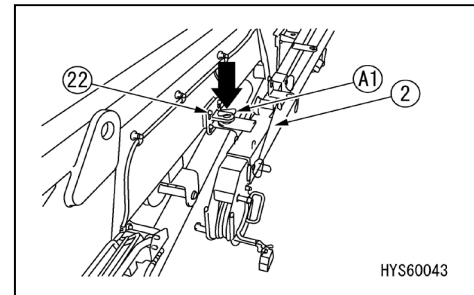

26. Insert the position pin (B1) into the hole closest to the front of the Fly-jib stowage bracket A (21) and insert the linchpin. At this time, be sure to turn over the ring to lock securely.

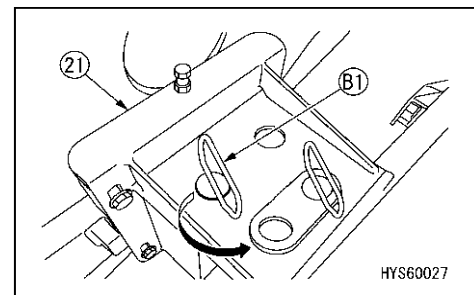

27. Hang the single hook (10) on the hook stowage rope (13). While pressing the hook stowage switch, perform winch raising operation to remove the slack of the wire rope (12).

**⚠ CAUTION**

Do not perform hook stowage operation with the override switch left ON. Doing so does not change the mode to the hook stowage mode, and the bracket, boom, wire rope (12), etc. of the hook stowage rope (13) are damaged. When performing hook stowage operation, be sure to use the hook stowage switch.

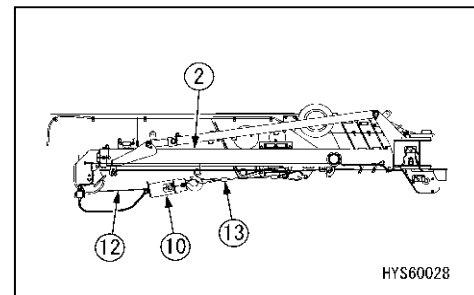



## CAUTION

In the case of the Fly-jib mode with the Fly-jib in a stowage condition, the monitor display is as shown on the right figure.

Either switch to the main boom mode or install the Fly-jib.

For the detailed operation method, see “5.1.2 Monitor display when Fly-jib is stowed”.

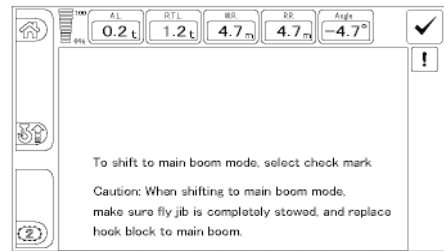

SAM19180

## 5. HANDLING MONITOR AND MOMENT LIMITER

### ⚠ WARNING

Do not perform work with the override switch left "ON".

Doing so may cause the hoisted load to fall, breakage of the boom, or overturning of machine due to overloading, leading to serious injury or even resulting in death.

### CAUTION

In this section, the devices indicated are exclusive for The Fly-jib model but different from that of a standard model. For devices other than these, refer to the section: "OPERATION 2.4 Moment Limiter".

### 5.1 NAMES OF MONITOR DISPLAY

#### 5.1.1 MONITOR DISPLAY IN FLY-JIB MODE

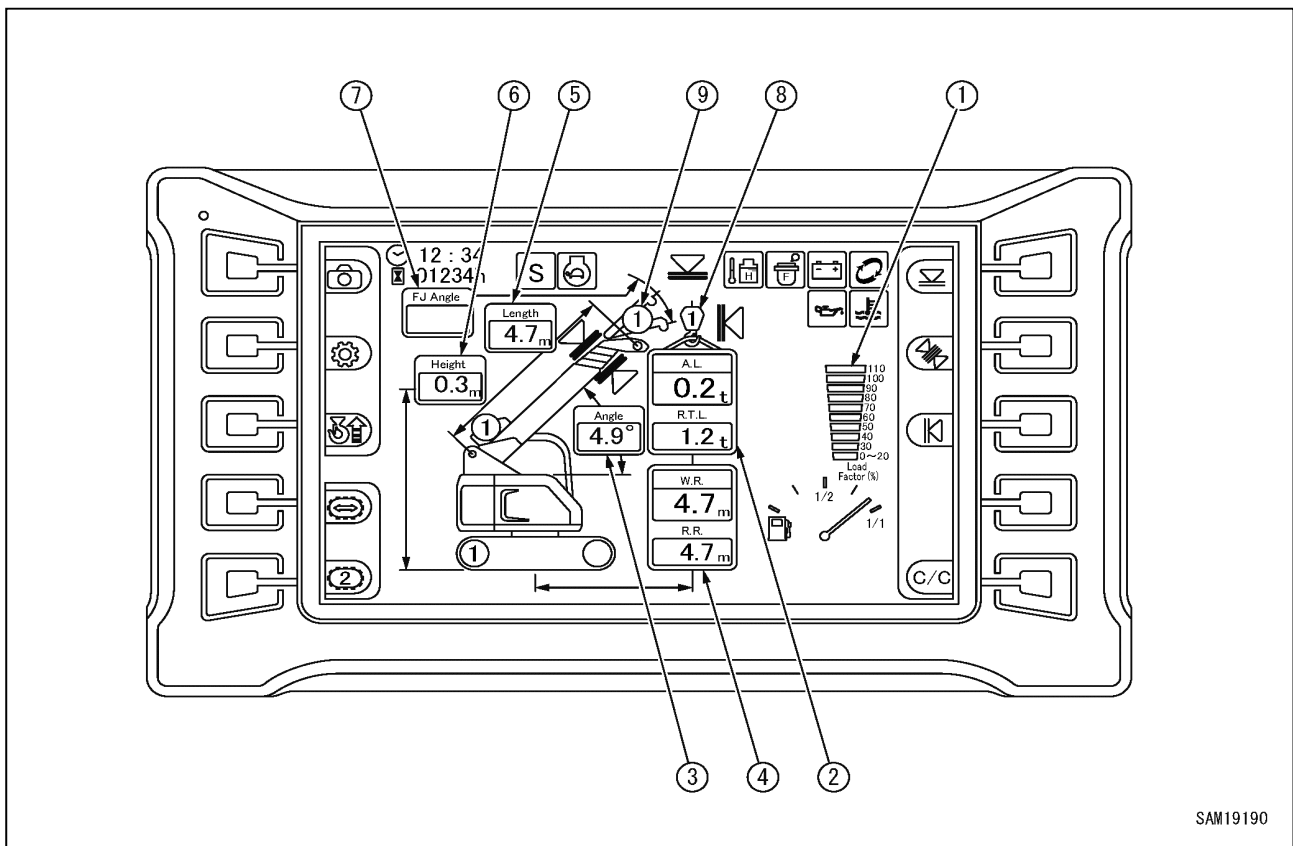

SAM19190

- |  |   |
|--|---|
| (1) Load capacity display                          | (6) Lifting height display              |
| (2) Actual load display / Rated total load display | (7) Fly-jib angle display               |
| (3) Boom angle display                             | (8) Display of number of falls of wire  |
| (4) Working radius display / Rated radius display  | (9) Display of number of Fly-jib stages |
| (5) Boom length display                            |   |



## CAUTION

**When the Fly-jib is installed on the main boom tip, the mode is automatically switched to the Fly-jib mode.**

**[1]** Explanation of each display of monitor

1. Fly-jib angle display (7)

The Fly-jib angle display indicates current Fly-jib angle continuously, during the crane operation.

Fly-jib angle means the angle between the Fly-jib and the main boom.

The Fly-jib angle is adjustable to four (4) positions, 0, 20, 40 and 60 degrees.

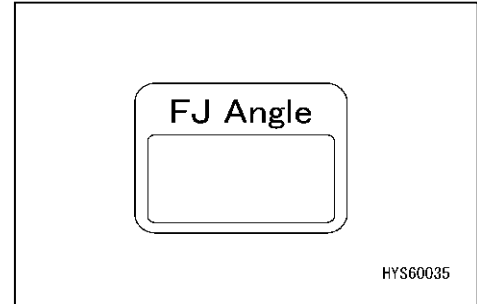

2. Display of number of Fly-jib stages (9)

The display changes to “R” when the Fly-jib is in a stowage state.

The display changes to “1” when the Fly-jib is in an installed state, and furthermore, when the No. 2 Fly-jib is drawn out, the display changes to “2”.

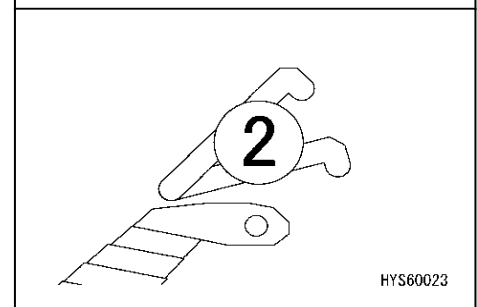
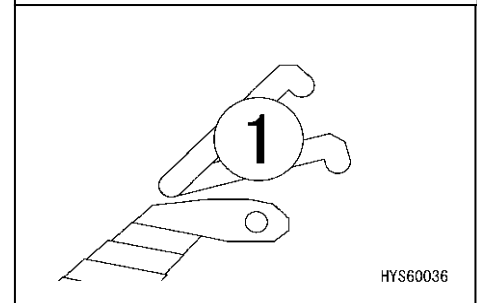
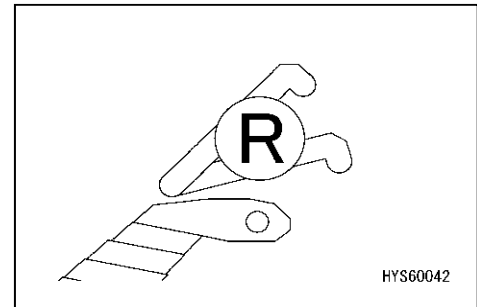

### 5.1.2 MONITOR DISPLAY WHEN FLY-JIB IS STOWED

When the Fly-jib is stowed just after it is used, the monitor changes to the following main boom work selection screen.

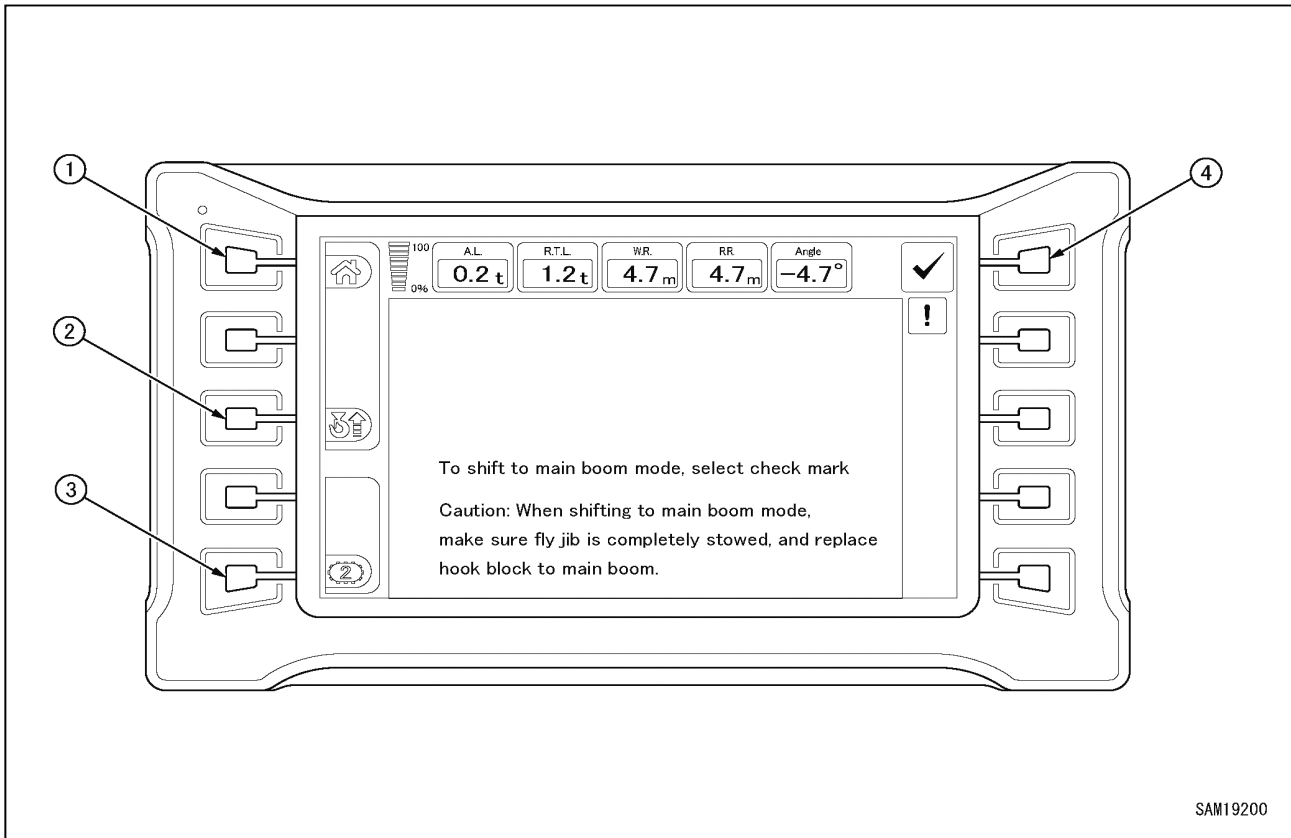

- (1) Rear view camera selector switch
- (2) Hook stowage switch

- (3) Travel 1st speed/2nd speed selector switch
- (4) Check switch

#### NOTES

When the Fly-jib is stowed, CAUTION is displayed on the monitor. After checking that the Fly-jib is completely stowed and replacing the hook with the main boom, press the check switch (4). The mode exits from the Fly-jib mode and the screen moves to the top screen of the main boom mode.

#### ⚠ WARNING

Do not perform work in the main boom mode by pressing the check switch (4) when the Fly-jib is not completely stowed. Otherwise, the boom or Fly-jib can break or fall down, leading to a serious personal accident such as death or serious injury.

#### CAUTION

The rear view camera selector switch (1), hook stowage switch (2) and travel 1st speed/2nd speed selector switch (3) can be operated without pressing the check switch (4) for a case in which the Fly-jib is temporarily stowed for the purpose of transportation, etc.

## 5.2 MOMENT LIMITER FUNCTIONS

### CAUTION

During the Fly-jib operations, always keep the boom angle in the range as specified below:

[At a Fly-jib angle in 0 or 20 degrees]

Perform the crane operation in the boom angle range of “45 degrees” or more. When a load is hoisted in a condition that the boom angle is less than “45 degrees” and the boom length is “5.3 m” or longer, the moment limiter emits a warning signal, the buzzer sounds intermittently, and hook hoisting, boom telescoping and boom lowering operations automatically stop. Such operations also automatically stop when it is beyond possible working range, and boom angle lower limit light on the monitor blinks in red.

However, when the boom length is less than “5.3 m”, the moment limiter does not emit a warning signal. In a condition where the boom angle is less than “45 degrees”, boom lowering operation is not available unless the boom length is less than “5.3 m”.

[At a Fly-jib angle in 40 or 60 degrees]

Perform the crane operation in the boom angle range of “65 degrees” or more. When a load is hoisted in a condition that the boom angle is less than “65 degrees” and the boom length is “5.3 m” or longer, the moment limiter emits a warning signal, the buzzer sounds intermittently, and hook hoisting, boom telescoping and boom lowering operations automatically stop. Such operations also automatically stop when it is beyond possible working range, and boom angle lower limit light on the monitor blinks in red.

However, when the boom length is less than “5.3 m”, the moment limiter does not emit a warning signal. In a condition where the boom angle is less than “65 degrees”, boom lowering operation is not available unless the boom length is less than “5.3 m”.

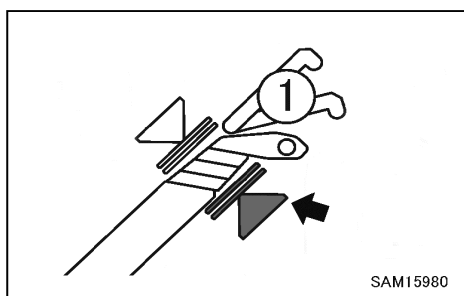
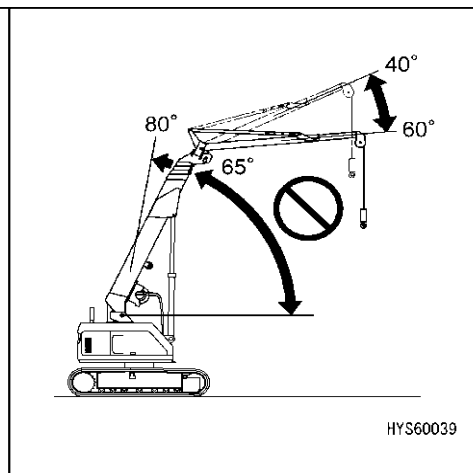
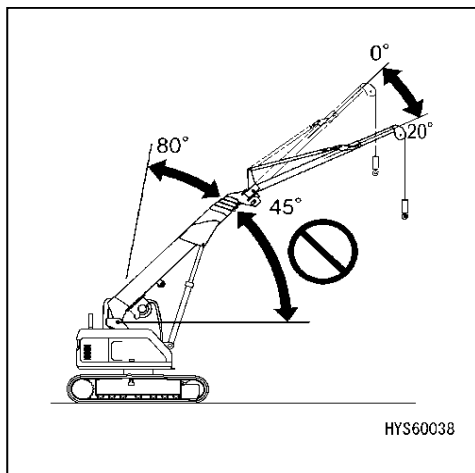



### 5.2.1 DISPLAY FOR FLY-JIB MODE SWITCHING

1. Fly-jib angle at 0 degree:

When the Fly-jib tilt angle is set to 0 degree, the Rated total load display, Working radius display, Fly-jib angle display and Lifting height display are switched to Fly-jib tilt angle 0 degree mode.

- The Fly-jib angle display indicates “0”.
- The Rated total load display indicates the value for Fly-jib tilt angle 0 degree mode.
- Working radius display indicates the value for Fly-jib tilt angle 0 degree mode.
- Lifting height display indicates the value for Fly-jib tilt angle 0 degree mode.

2. Fly-jib angle at 20 degrees:

When the Fly-jib tilt angle is set to 20 degrees, the Rated total load display, Working radius display, Fly-jib angle display and Lifting height display are switched to Fly-jib tilt angle 20 degrees mode.

- The Fly-jib angle display indicates “20”.
- The Rated total load display indicates the value for Fly-jib tilt angle 20 degrees mode.
- Working radius display indicates the value for Fly-jib tilt angle 20 degrees mode.
- Lifting height display indicates the value for Fly-jib tilt angle 20 degrees mode.

3. Fly-jib angle at 40 degrees:

When the Fly-jib tilt angle is set to 40 degrees, the Rated total load display, Working radius display, Fly-jib angle display and Lifting height display are switched to Fly-jib tilt angle 40 degrees mode.

- The Fly-jib angle display indicates “40”.
- The Rated total load display indicates the value for Fly-jib tilt angle 40 degrees mode.
- Working radius display indicates the value for Fly-jib tilt angle 40 degrees mode.
- Lifting height display indicates the value for Fly-jib tilt angle 40 degrees mode.

4. Fly-jib angle at 60 degrees:

When the Fly-jib tilt angle is set to 60 degrees, the Rated total load display, Working radius display, Fly-jib angle display and Lifting height display are switched to Fly-jib tilt angle 60 degrees mode.

- The Fly-jib angle display indicates “60”.
- The Rated total load display indicates the value for Fly-jib tilt angle 60 degrees mode.
- Working radius display indicates the value for Fly-jib tilt angle 60 degrees mode.
- Lifting height display indicates the value for Fly-jib tilt angle 60 degrees mode.



### 5.3 SETTING OF OPERATING CONDITIONS

#### CAUTION

When the Fly-jib is installed to the main boom tip, the machine turns into the following operation state.

- The rated total load value displayed on the monitor is switched to the one for the Fly-jib.
- When the Fly-jib tilt angle is set to 0 or 20 degrees, load hoisting operation is not available where the boom angle is "45 degrees" or less. The moment limiter emits an over-load warning.
- When the Fly-jib tilt angle is set to 40 or 60 degrees, load hoisting operation is not available where the boom angle is "65 degrees" or less. The moment limiter emits an over-load warning.
- The raising and lowering operation of the winch is fixed to the low speed (1st speed).
- The number of falls of hook selector button is disabled and the number of falls is fixed to "Single fall".

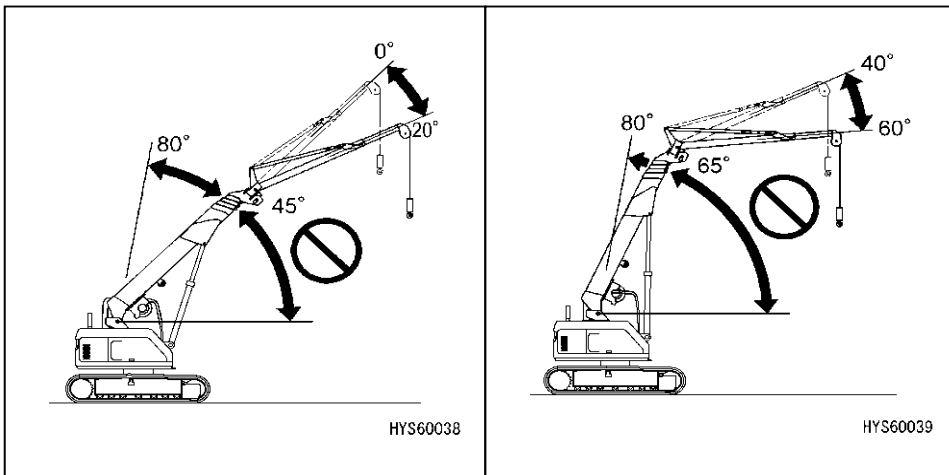



## 6. OPERATIONS

### CAUTION

In this section, the devices indicated are exclusive to a Fly-jib model but different from those of a standard model. For devices other than these, refer to the section: "OPERATION 3. Machine Operation".

### 6.1 CAUTIONS FOR FLY-JIB OPERATION

- Whenever the Fly-jib is installed, always keep the engine speed in low idling so that the machine is operated in low speed. Sudden lever operation may produce excessive load to the Fly-jib which may cause Fly-jib breakage resulting in a serious accident.
- At a Fly-jib angle in 0 or 20 degrees, perform the crane operation in the boom angle range of "45 degrees" or more. When a load is hoisted in a condition that the boom angle is less than "45 degrees" and the boom length is "5.3 m" or longer, the moment limiter emits a warning signal, the buzzer sounds intermittently, and hook hoisting, boom telescoping and boom lowering operations automatically stop. However, when the boom length is less than "5.3 m", the moment limiter does not emit a warning signal. In a condition where the boom angle is less than "45 degrees", boom lowering operation is not available unless the boom length is less than "5.3 m".
- At a Fly-jib angle in 40 or 60 degrees, perform the crane operation in the boom angle range of "65 degrees" or more. When a load is hoisted in a condition that the boom angle is less than "65 degrees" and the boom length is "5.3 m" or longer, the moment limiter emits a warning signal, the buzzer sounds intermittently, and hook hoisting, boom telescoping and boom lowering operations automatically stop. However, when the boom length is less than "5.3 m", the moment limiter does not emit a warning signal. In a condition where the boom angle is less than "65 degrees", boom lowering operation is not available unless the boom length is less than "5.3 m".
- Travelling is prohibited when the Fly-jib is installed.  
However, travelling is allowed if the boom length is 5.3 m or less and actual load is 0.2 tons or less.



## 7. TROUBLESHOOTING

### 7.1 LIST OF ERROR CODES

Fly-jib related errors displayed on the monitor are as follows. If the following error codes are displayed, see “FLY-JIB 7.2 When such a phenomenon occurs”.

If the error codes other than the below are displayed, a cause other than a Fly-jib related cause is conceivable. See “Operation 2.1.2 Warning display”.

Monitor display		Warning buzzer	Description
Error code	Item		
EFJ01	FlyJib Error 1	●	Fly-jib is detected as stowed although not mounted on the vehicle.
EFJ02	FlyJib Error 2	●	Fly-jib is stowed, but rewiring has not been completed and remains connected to the Fly-jib.
EFJ03	FlyJib Error 3	●	Rewiring has been completed, but Fly-jib is not detected as stowed.



## 7.2 WHEN SUCH A PHENOMENON OCCURS

- Make sure that you contact us or our sales service agency for the actions marked with ★ in the table.
- Ask us or our sales service agency for repair if you suspect any other abnormalities or causes than those given below.

[1] When Fly-jib is not installed on machine body

Abnormal phenomenon	Major cause(s)	Remedy
Error code "EFJ01" is displayed.	<ul style="list-style-type: none"> <li>• Breaking of stowage limit switch wiring</li> <li>• Short connector faulty, disconnected</li> </ul>	<ul style="list-style-type: none"> <li>★ Inspection and repair of breaking of wiring</li> <li>★ Inspection and replacement of short connector</li> </ul>
The monitor display changes to the Fly-jib mode.	<ul style="list-style-type: none"> <li>• Setting failure</li> </ul>	<ul style="list-style-type: none"> <li>★ Setting change</li> </ul>

[2] When Fly-jib is installed on machine body and is stowed (Fly-jib mode)

Abnormal phenomenon	Major cause(s)	Remedy
Error code "EFJ02" is displayed.	<ul style="list-style-type: none"> <li>• No rewiring has been performed.</li> </ul>	<ul style="list-style-type: none"> <li>• Rewire wires connected to Fly-jib.</li> </ul>
Error code "EFJ03" is displayed.	<ul style="list-style-type: none"> <li>• Fly-jib is not stowed properly.</li> <li>• Defective stowage limit switch</li> </ul>	<ul style="list-style-type: none"> <li>• Stow Fly-jib until contact is made with the stowage limit switch.</li> <li>★ Inspection and replacement of limit switch</li> </ul>
The selection screen of the main boom mode does not appear. (Stowage is not detected.)	<ul style="list-style-type: none"> <li>• Defective stowage limit switch</li> <li>• Defective wiring</li> </ul>	<ul style="list-style-type: none"> <li>★ Inspection and replacement of limit switch</li> <li>★ Inspection and repair of wiring</li> </ul>

[3] When Fly-jib is installed on machine body and is workable (Fly-jib mode)

Abnormal phenomenon	Major cause(s)	Remedy
The display of the number of stages of the Fly-jib does not change.	<ul style="list-style-type: none"> <li>• Disconnection of and omission of replacement of connector</li> </ul>	<ul style="list-style-type: none"> <li>• Check of connector status</li> <li>★ Inspection and repair of breaking of wiring</li> </ul>
The display of the Fly-jib angle does not change.	<ul style="list-style-type: none"> <li>• Breakage of limit switch wiring</li> <li>• Defective limit switch</li> </ul>	<ul style="list-style-type: none"> <li>★ Inspection and replacement of limit switch</li> </ul>
The monitor display does not change to the Fly-jib mode.	<ul style="list-style-type: none"> <li>• Setting failure</li> </ul>	<ul style="list-style-type: none"> <li>★ Setting change</li> </ul>

## 8. INSPECTION AND MAINTENANCE

### CAUTION

In this section, the devices indicated are exclusive to a Fly-jib model but different from those of a standard model. For devices other than these, refer to the section: "INSPECTION AND MAINTENANCE".

### 8.1 CHECKING BEFORE OPERATION

Check the followings in this section before first starting work every day after installing fly-jib.

#### [1] CHECKING AROUND FLY-JIB

- Check each part of the fly-jib for cracks, excessive deformation, and contamination etc. In addition, check bolts, nuts and pins for any looseness, drop, and damage etc. Be especially careful to check for excessive abrasion and damage of the position pins. If you find any abnormality, repair.
- Check for excessive damage and deformity of the over hoist weight wire rope of the over winding alarm device at the tip of the fly-jib. If there is any abnormality, repair.
- Check for excessive damage and deformity of the cord reel on the left side surface of the fly-jib. If there is any abnormality, repair.
- Check for sagged electrical wire, loose connections and trace of burns. If you find any abnormality, repair.

#### [2] CHECKING HOOK BLOCK

- Verify that the wire rope latch (1) functions normally. If there is any abnormality, repair.
- Rotate the hook and verify that the hook rotates smoothly and that the trunnion does not emit any abnormal sound. If there is any abnormality, repair.
- Check the hook for any cracks or excessive deformation. If there is any abnormality, repair.

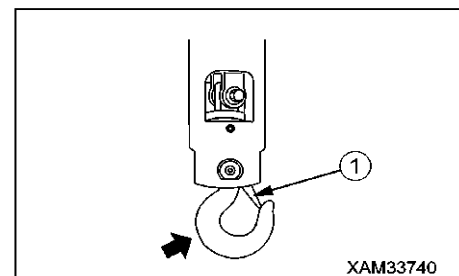



**[3] CHECKING MOMENT LIMITER FOR OPERATION**

**⚠ WARNING**

**If you find any abnormality with the moment limiter, immediately contact us or our sales service agency.**

1. Turn the starter switch to the ON position.
2. Check the working status lamp. All 3 colors light first, then only the green light remains lit.
3. Check that error codes are not displayed on the monitor display.
4. Set the Fly-jib as follows and check if the monitor display at this time is correct.

Crane Operation and Displayed Parameter	Monitor display
“Number of stages of Fly-jib” indication when the number of stages of the Fly-jib is set to one stage	1
“Number of stages of Fly-jib” indication when the number of stages of the Fly-jib is set to two stages	2
“Fly-jib angle display” indication, when the Fly-jib tilt angle is set to 0	0
“Fly-jib angle display” indication, when the Fly-jib tilt angle is set to 20	20
“Fly-jib angle display” indication, when the Fly-jib tilt angle is set to 40	40
“Fly-jib angle display” indication, when the Fly-jib tilt angle is set to 60	60

5. Start the engine and operate the crane as follows to verify if the moment limiter is acting properly for each function.

Crane operation	Action of Moment Limiter
When the Fly-jib angle is 0 or 20 degrees, the boom angle is lowered to 45 degrees or less and the boom is extended to 5.3 m or more.	<ul style="list-style-type: none"> <li>• An over-load warning is emitted and the buzzer sounds intermittently.</li> <li>• The hook hoisting, boom telescoping and boom lowering operation automatically stop.</li> </ul>
When the Fly-jib angle is 0 or 20 degrees, the boom angle is lowered to 45 degrees or less but the boom is extended to less than 5.3 m.	<ul style="list-style-type: none"> <li>• The boom lowering operation is available.</li> </ul>
When the Fly-jib angle is 40 or 60 degrees, the boom angle is lowered to 65 degrees or less and the boom is extended to 5.3 m or more	<ul style="list-style-type: none"> <li>• An over-load warning is emitted and the buzzer sounds intermittently.</li> <li>• The hook hoisting, boom telescoping and boom lowering operation automatically stop.</li> </ul>
When the Fly-jib angle is 40 or 60 degrees, the boom angle is lowered to 65 degrees or less but the boom is extended to less than 5.3 m.	<ul style="list-style-type: none"> <li>• The boom lowering operation is available.</li> </ul>

## 8.2 MAINTENANCE EVERY 50 HOURS

### [1] GREASING

#### CAUTION

- Grease a new machine regularly until it has been operated for 100 hours, that is the time when the machine will have settled down and may be considered as run-in.
- Any unusual noise at greasing points requires immediate greasing regardless of the maintenance period.

Use a grease type in the following table depending on the greasing point.

No.	Greasing Point		Grease Type
1	Hook block greasing	2 Places	Lithium grease
2			
3	Fly-jib angle adjusting outer rod pin greasing	1 place	
4	Fly-jib angle adjusting inner rod pin greasing	1 place	
5	Fly-jib foot pin greasing	1 place	

1. Grease, by using a grease pump, to the grease fitting indicated with an arrow.
2. Cleanly wipe off the old grease that was pushed out after greasing.

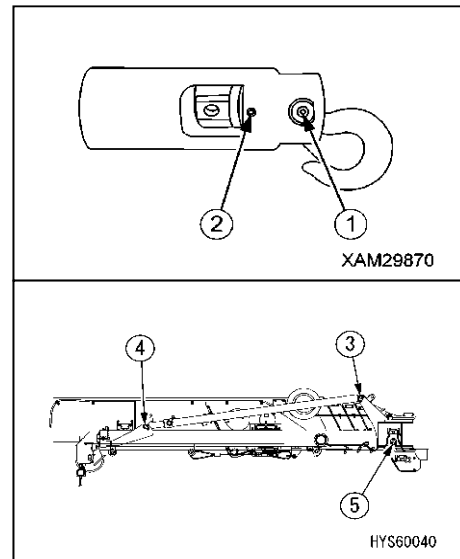



## 9. SPECIFICATIONS

### 9.1 SPECIFICATION TABLE

#### CAUTION

In this section, the data indicated is exclusive for the Fly-jib model but different from those of a standard model.  
For data other than this, refer to the section: "SPECIFICATIONS".

System / Item		CC1485S-1 FLY-JIB
Mass and dimensions	Machine mass	14,700 kg
	Overall length x width x height	6,560 mm × 2,490 mm × 2,865 mm
	Distance between idler and sprocket	2,880 mm
	Track gauge	1,990 mm
	Track width	500 mm



## 9.2 SPECIFICATION DIMENSIONAL DRAWING

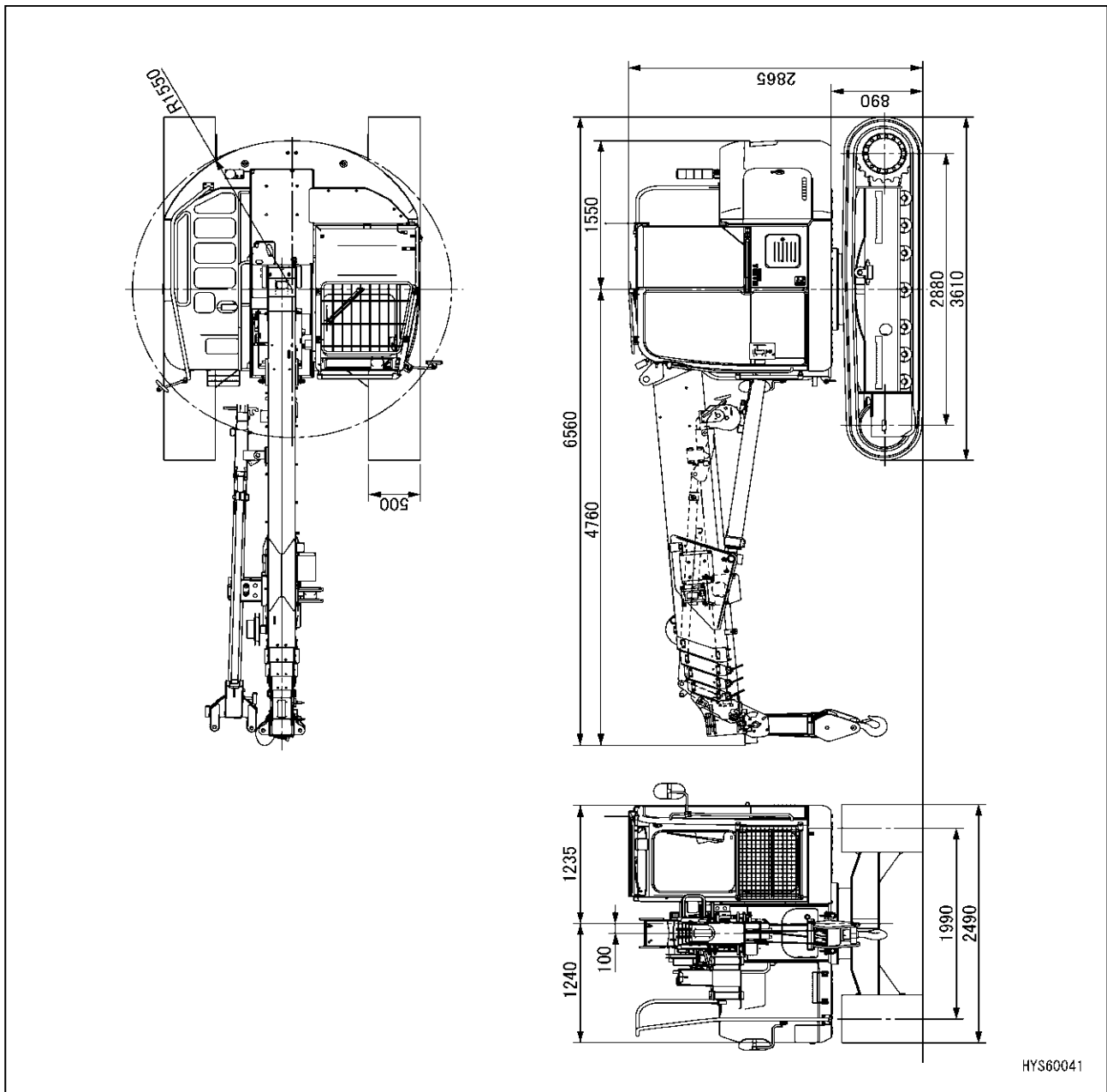



### 9.3 RATED TOTAL LOAD CHART

#### CAUTION

- The rated total load is a load including the weight of the hook block (20 kg).
- During the Fly-jib operations, the boom angle range must be kept at “45 degrees” or more when the Fly-jib tilt angle is “0 or 20 degrees”. Or, the boom angle range must be kept at “65 degrees” or more when the Fly-jib tilt angle is “40 or 60 degrees”.

Unit: kg

Boom angle (deg)	Jib tilt angle			
	0 deg	20 deg	40 deg	60 deg
80	820	820	620	620
75	820	820	620	620
70	720	720	520	520
65	620	620	420	420
60	520	520	Prohibited under 65 deg	
55	420	420		
50	320	320		
45	220	220		
40	Prohibited under 45 deg			

- ★The rated total load table indicates values which include all the weight of utensils for hoisting (including a single line hook, approx. 20 kg).
- ★The rated total load table is common to both of the Fly-jib configurations, using No. 1 only or both No.1 and 2.

## 9.4 WORKING RADIUS/LIFTING HEIGHT

### 9.4.1 WORKING RADIUS/LIFTING HEIGHT (WHEN FLY-JIB ANGLE IS 0 DEGREES AND 20 DEGREES)

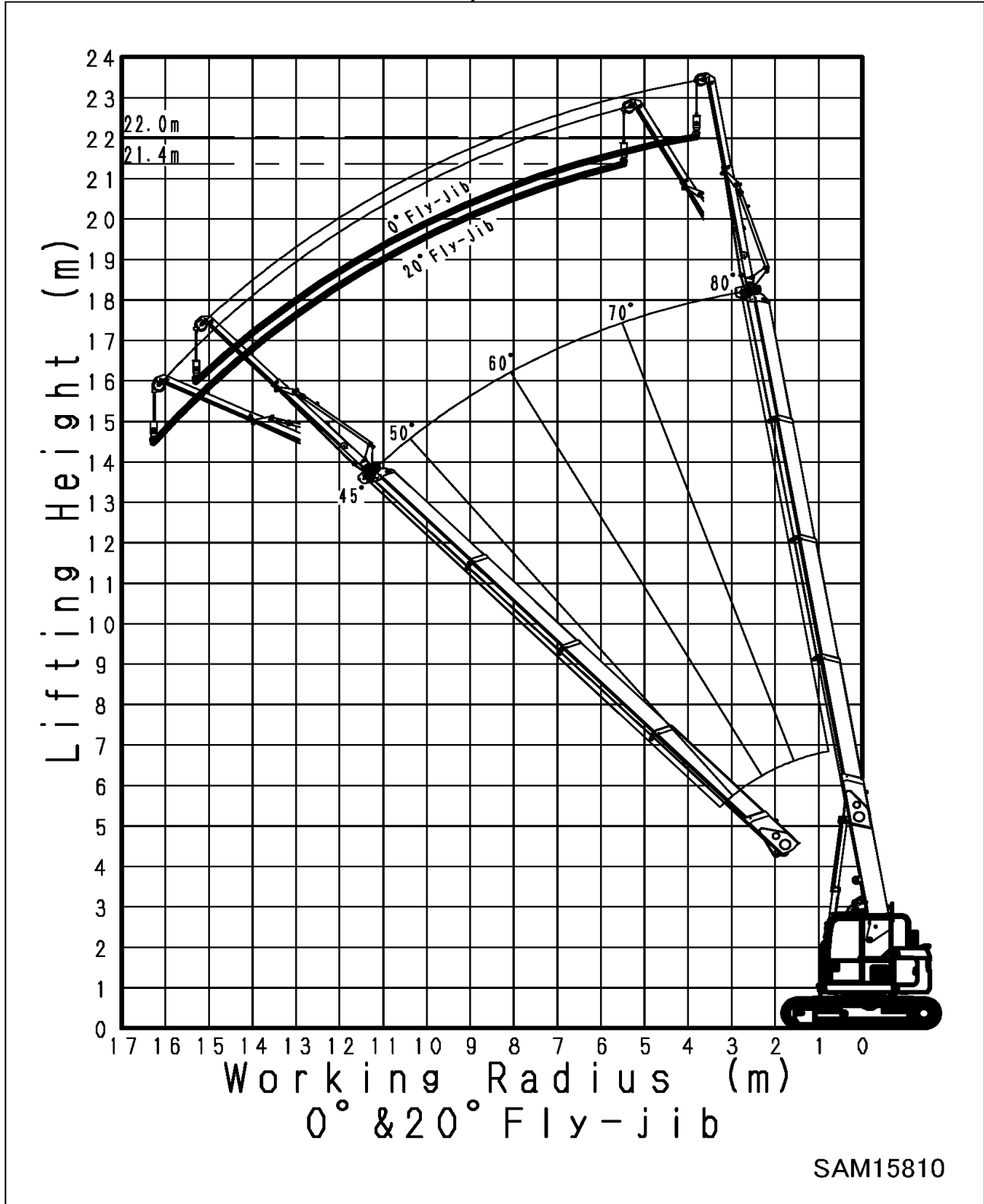

**9.4.2 WORKING RADIUS/LIFTING HEIGHT (WHEN FLY-JIB ANGLE IS 40 DEGREES AND 60 DEGREES)**

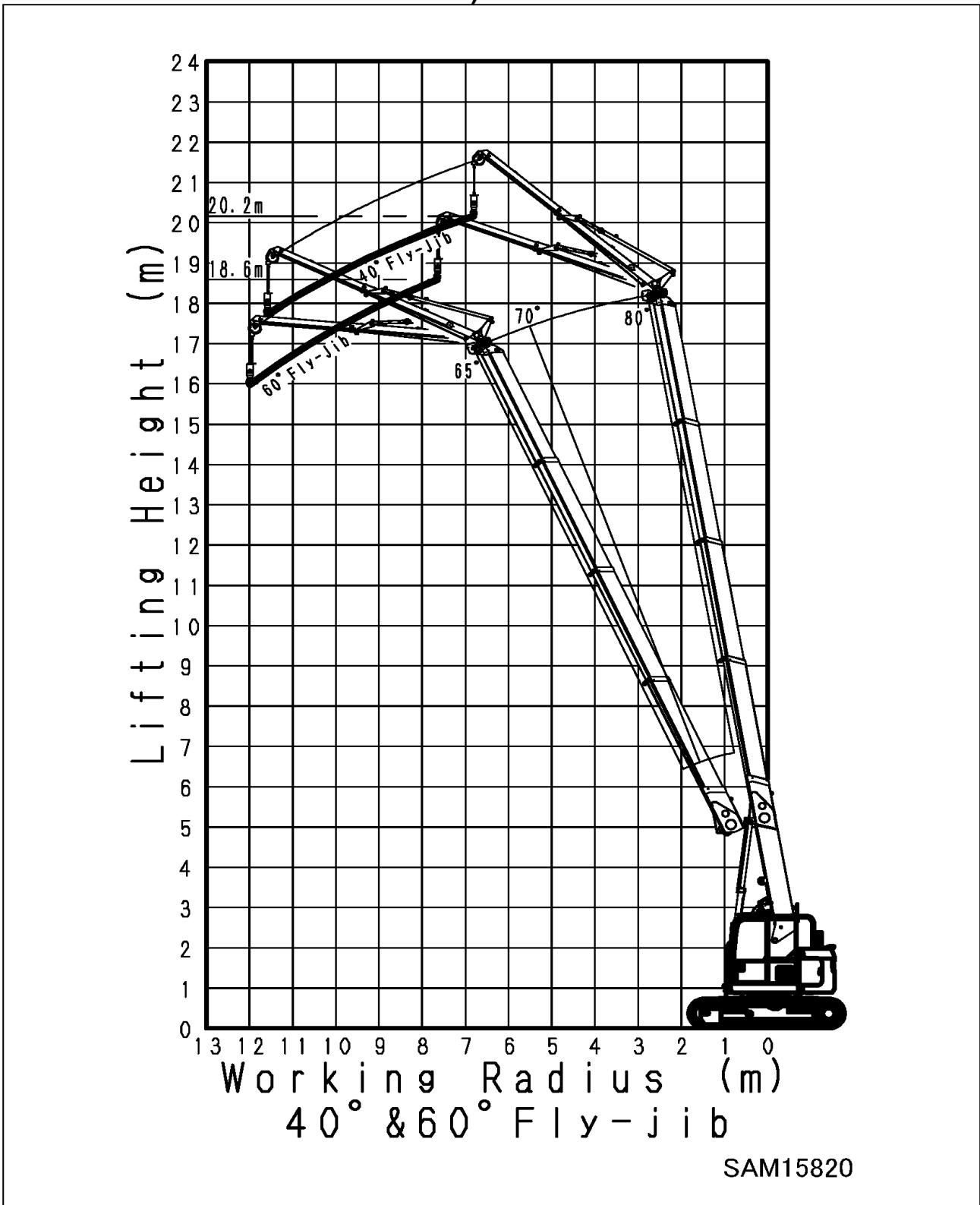



## **OPERATION MANUAL for MAEDA CRAWLER CRANE CC1485S-1**

---

Document Number    585E-OM1712-02  
First edition        November 30, 2015  
Third edition        December 25, 2017

Issued by MAEDA SEISAKUSHO CO., LTD.  
1095, Onbegawa, Shinonoi, Nagano City,  
Nagano Prefecture, 388-8522 Japan





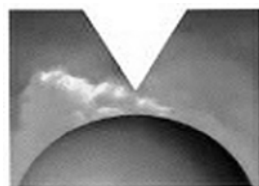

**M A E D A**